



# 512MB – 2x32Mx72 DDR ECC SDRAM UNBUFFERED w/PLL

## FEATURES

- Double-data-rate architecture
- DDR200, DDR266 DDR333
  - JEDEC design specifications
- Bi-directional data strobes (DQS)
- Differential clock inputs (CK & CK#)
- Programmable Read Latency 2,2.5 (clock)
- Programmable Burst Length (2,4,8)
- Programmable Burst type (sequential & interleave)
- Edge aligned data output, center aligned data input
- Auto and self refresh
- Serial presence detect
- Dual Rank
- Power supply: 2.5V ± 0.2V
- 200 pin SO-DIMM package
  - Package height options:
    - AD4: 35.05 mm (1.38")
    - BD4: 31.75 mm (1.25")

## DESCRIPTION

The W3EG7264S is a 2x32Mx72 Double Data Rate SDRAM memory module based on 512Mb DDR SDRAM components. The module consists of nine 64Mx8 DDR SDRAMs stacked in 54 pin TSOP packages mounted on a 200 pin FR4 substrate. This module is structured as 2 Ranks of 64Mx72 DDR SDRAM.

Synchronous design allows precise cycle control with the use of system clock. Data I/O transactions are possible on both edges and Burst Lengths allow the same device to be useful for a variety of high bandwidth, high performance memory system applications.

\* This product is under development, is not qualified or characterized and is subject to change without notice.

NOTE: Consult factory for availability of:

- RoHS compliant products
- Vendor source control options
- Industrial temperature option

## OPERATING FREQUENCIES

	DDR333@CL=2.5	DDR266@CL=2	DDR266@CL=2.5	DDR200@CL=2
Clock Speed	166MHz	133MHz	133MHz	100MHz
CL-tRCD-tRP	2.5-3-3	2-2-2	2.5-3-3	2-2-2

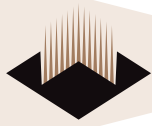

## PIN CONFIGURATION

Pin	Symbol	Pin	Symbol	Pin	Symbol	Pin	Symbol
1	V <sub>REF</sub>	51	V <sub>SS</sub>	101	A9	151	DQ42
2	V <sub>REF</sub>	52	V <sub>SS</sub>	102	A8	152	DQ46
3	V <sub>SS</sub>	53	DQ19	103	V <sub>SS</sub>	153	DQ43
4	V <sub>SS</sub>	54	DQ23	104	V <sub>SS</sub>	154	DQ47
5	DQ0	55	DQ24	105	A7	155	V <sub>CC</sub>
6	DQ4	56	DQ28	106	A6	156	V <sub>CC</sub>
7	DQ1	57	V <sub>CC</sub>	107	A5	157	V <sub>CC</sub>
8	DQ5	58	V <sub>CC</sub>	108	A4	158	CK1#*
9	V <sub>CC</sub>	59	DQ25	109	A3	159	V <sub>SS</sub>
10	V <sub>CC</sub>	60	DQ29	110	A2	160	CK1*
11	DQS0	61	DQS3	111	A1	161	V <sub>SS</sub>
12	DQM0	62	DQM3	112	A0	162	V <sub>SS</sub>
13	DQ2	63	V <sub>SS</sub>	113	V <sub>CC</sub>	163	DQ48
14	DQ6	64	V <sub>SS</sub>	114	V <sub>CC</sub>	164	DQ52
15	V <sub>SS</sub>	65	DQ26	115	A10/AP	165	DQ49
16	V <sub>SS</sub>	66	DQ30	116	BA1	166	DQ53
17	DQ3	67	DQ27	117	BA0	167	V <sub>CC</sub>
18	DQ7	68	DQ31	118	RAS#	168	V <sub>CC</sub>
19	DQ8	69	V <sub>CC</sub>	119	WE#	169	DQS6
20	DQ12	70	V <sub>CC</sub>	120	CAS#	170	DQM6
21	V <sub>CC</sub>	71	CB0	121	CS0#	171	DQ50
22	V <sub>CC</sub>	72	CB4	122	CS1#	172	DQ54
23	DQ9	73	CB1	123	NC	173	V <sub>SS</sub>
24	DQ13	74	CB5	124	NC	174	V <sub>SS</sub>
25	DQS1	75	V <sub>SS</sub>	125	V <sub>SS</sub>	175	DQ51
26	DQM1	76	V <sub>SS</sub>	126	V <sub>SS</sub>	176	DQ55
27	V <sub>SS</sub>	77	DQS8	127	DQ32	177	DQ56
28	V <sub>SS</sub>	78	DQM8	128	DQ36	178	DQ60
29	DQ10	79	CB2	129	DQ33	179	V <sub>CC</sub>
30	DQ14	80	CB6	130	DQ37	180	V <sub>CC</sub>
31	DQ11	81	V <sub>CC</sub>	131	V <sub>CC</sub>	181	DQ57
32	DQ15	82	V <sub>CC</sub>	132	V <sub>CC</sub>	182	DQ61
33	V <sub>CC</sub>	83	CB3	133	DQS4	183	DQS7
34	V <sub>CC</sub>	84	CB7	134	DQM4	184	DQM7
35	CK0	85	NC	135	DQ34	185	V <sub>SS</sub>
36	V <sub>CC</sub>	86	NC	136	DQ38	186	V <sub>SS</sub>
37	CK0#	87	V <sub>SS</sub>	137	V <sub>SS</sub>	187	DQ58
38	V <sub>SS</sub>	88	V <sub>SS</sub>	138	V <sub>SS</sub>	188	DQ62
39	V <sub>SS</sub>	89	CK2*	139	DQ35	189	DQ59
40	V <sub>SS</sub>	90	V <sub>SS</sub>	140	DQ39	190	DQ63
41	DQ16	91	CK2#*	141	DQ40	191	V <sub>CC</sub>
42	DQ20	92	V <sub>CC</sub>	142	DQ44	192	V <sub>CC</sub>
43	DQ17	93	V <sub>CC</sub>	143	V <sub>CC</sub>	193	SDA
44	DQ21	94	V <sub>CC</sub>	144	V <sub>CC</sub>	194	SA0
45	V <sub>CC</sub>	95	CKE1	145	DQ41	195	SCL
46	V <sub>CC</sub>	96	CKE0	146	DQ45	196	SA1
47	DQS2	97	NC	147	DQS5	197	V <sub>CCSPD</sub>
48	DQM2	98	NC	148	DQM5	198	SA2
49	DQ18	99	A12	149	V <sub>SS</sub>	199	V <sub>CCID</sub>
50	DQ22	100	A11	150	V <sub>SS</sub>	200	NC

## PIN NAMES

A0 – A12	Address input (Multiplexed)
BA0-BA1	Bank Select Address
DQ0-DQ63	Data Input/Output
CB0-CB7	Check bits
DQS0-DQS8	Data Strobe Input/Output
CK0	Clock Input
CK0#	Clock input
CKE0-CKE1	Clock Enable input
CS0#-CS1#	Chip select Input
RAS#	Row Address Strobe
CAS#	Column Address Strobe
WE#	Write Enable
DQM0-DQM8	Data-In Mask
V <sub>CC</sub>	Power Supply (2.5V)
V <sub>SS</sub>	Ground
V <sub>REF</sub>	Power Supply for Reference
V <sub>CCSPD</sub>	Serial EEPROM Power Supply (2.3V to 3.6V)
SDA	Serial data I/O
SCL	Serial clock
SA0-SA2	Address in EEPROM
V <sub>CCID</sub>	V <sub>CC</sub> Identification Flag
NC	No Connect

\* Not Used

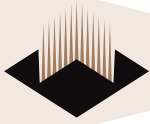

FUNCTIONAL BLOCK DIAGRAM

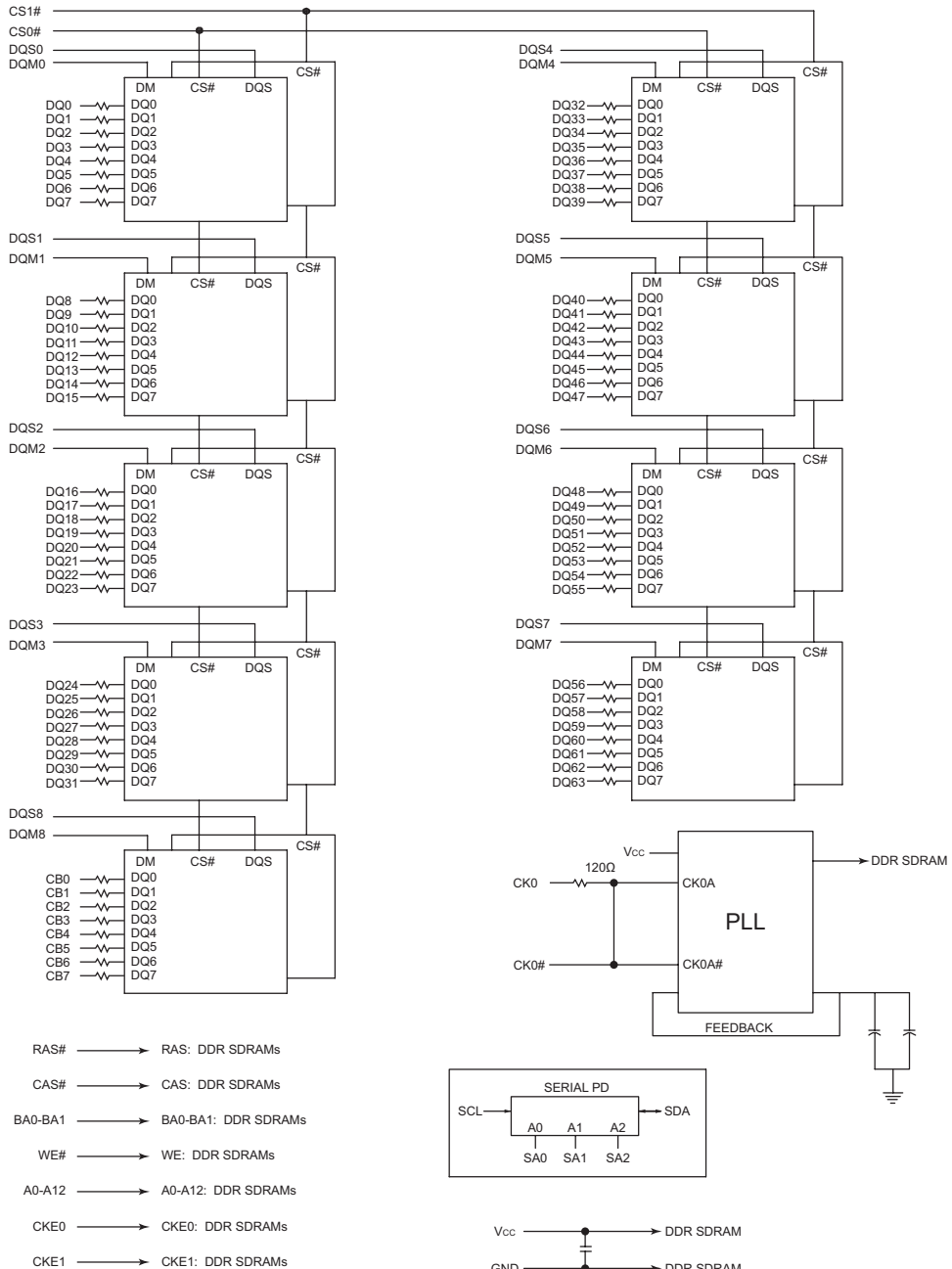

NOTE: All datalines are terminated through a 22 ohm series resistor.

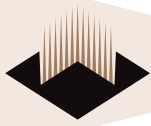

## ABSOLUTE MAXIMUM RATINGS

Parameter	Symbol	Value	Units
Voltage on any pin relative to V <sub>SS</sub>	V <sub>IN</sub> , V <sub>OUT</sub>	-0.5 ~ 3.6	V
Voltage on V <sub>CC</sub> supply relative to V <sub>SS</sub>	V <sub>CC</sub> , V <sub>CCQ</sub>	-1.0 ~ 3.6	V
Storage Temperature	T <sub>STG</sub>	-55 ~ +150	°C
Power Dissipation	P <sub>D</sub>	9	W
Short Circuit Current	I <sub>OS</sub>	50	mA

**Note:**

Permanent device damage may occur if "ABSOLUTE MAXIMUM RATINGS" are exceeded.

Functional operation should be restricted to recommended operating condition.

Exposure to higher than recommended voltage for extended periods of time could affect device reliability.

## DC CHARACTERISTICS

0°C ≤ T<sub>A</sub> ≤ 70°C, V<sub>CC</sub> = 2.5V ± 0.2V

Parameter	Symbol	Min	Max	Unit
Supply Voltage	V <sub>CC</sub>	2.3	2.7	V
Supply Voltage	V <sub>CCQ</sub>	2.3	2.7	V
Reference Voltage	V <sub>REF</sub>	1.15	1.35	V
Termination Voltage	V <sub>TT</sub>	1.15	1.35	V
Input High Voltage	V <sub>IH</sub>	V <sub>REF</sub> + 0.15	V <sub>CCQ</sub> + 0.3	V
Input Low Voltage	V <sub>IL</sub>	-0.3	V <sub>REF</sub> - 0.15	V
Output High Voltage	V <sub>OH</sub>	V <sub>TT</sub> + 0.76	—	V
Output Low Voltage	V <sub>OL</sub>	—	V <sub>TT</sub> - 0.76	V

## CAPACITANCE

T<sub>A</sub> = 25°C, f = 1MHz, V<sub>CC</sub> = 2.5V

Parameter	Symbol	Max	Unit
Input Capacitance (A0-A12)	C <sub>IN1</sub>	56	pF
Input Capacitance (RAS#,CAS#,WE#)	C <sub>IN2</sub>	56	pF
Input Capacitance (CKE0,CKE1)	C <sub>IN3</sub>	29	pF
Input Capacitance (CK0,CK0#)	C <sub>IN4</sub>	5.5	pF
Input Capacitance (CS0#,CS1#)	C <sub>IN5</sub>	29	pF
Input Capacitance (DQM0-DQM8)	C <sub>IN6</sub>	13	pF
Input Capacitance (BA0-BA1)	C <sub>IN7</sub>	56	pF
Data input/output Capacitance (DQ0-DQ63)(DQS)	C <sub>OUT</sub>	13	pF
Data input/output Capacitance (CB0-CB7)	C <sub>OUT</sub>	13	pF

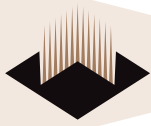

## I<sub>DD</sub> SPECIFICATIONS AND TEST CONDITIONS

Recommended operating conditions, 0°C ≤ T<sub>A</sub> ≤ 70°C, V<sub>CCQ</sub> = 2.5V ± 0.2V, V<sub>CC</sub> = 2.5V ± 0.2V

Parameter	Symbol	Conditions	DDR333@CL=2.5	DDR266@CL=2, 2.5	DDR200@CL=2	Units
			Max	Max	Max	
Operating Current	I <sub>DD0</sub>	One device bank; Active - Precharge; (MIN); DQ, DM and DQS inputs changing once per clock cycle; Address and control inputs changing once every two cycles. T <sub>RC</sub> =T <sub>RC</sub> (MIN); T <sub>CK</sub> =T <sub>CK</sub>	2205	2025	2025	mA
Operating Current	I <sub>DD1</sub>	One device bank; Active-Read-Precharge; Burst = 2; T <sub>RC</sub> =T <sub>RC</sub> (MIN); T <sub>CK</sub> =T <sub>CK</sub> (MIN); I <sub>OUT</sub> = 0mA; Address and control inputs changing once per clock cycle.	2610	2340	2340	mA
Precharge Power-Down Standby Current	I <sub>DD2P</sub>	All device banks idle; Power-down mode; T <sub>CK</sub> =T <sub>CK</sub> (MIN); CKE=(low)	72	72	72	mA
Idle Standby Current	I <sub>DD2F</sub>	CS# = High; All device banks idle; T <sub>CK</sub> =T <sub>CK</sub> (MIN); CKE = high; Address and other control inputs changing once per clock cycle. V <sub>IN</sub> = V <sub>REF</sub> for DQ, DQS and DM.	900	810	810	mA
Active Power-Down Standby Current	I <sub>DD3P</sub>	One device bank active; Power-down mode; T <sub>CK</sub> (MIN); CKE=(low)	540	450	450	mA
Active Standby Current	I <sub>DD3N</sub>	CS# = High; CKE = High; One device bank; Active-Precharge; T <sub>RC</sub> =T <sub>RAS</sub> (MAX); T <sub>CK</sub> =T <sub>CK</sub> (MIN); DQ, DM and DQS inputs changing twice per clock cycle; Address and other control inputs changing once per clock cycle.	1080	900	900	mA
Operating Current	I <sub>DD4R</sub>	Burst = 2; Reads; Continuous burst; One device bank active; Address and control inputs changing once per clock cycle; T <sub>CK</sub> =T <sub>CK</sub> (MIN); I <sub>OUT</sub> = 0mA.	2655	2250	2250	mA
Operating Current	I <sub>DD4W</sub>	Burst = 2; Writes; Continuous burst; One device bank active; Address and control inputs changing once per clock cycle; T <sub>CK</sub> =T <sub>CK</sub> (MIN); DQ, DM and DQS inputs changing twice per clock cycle.	2655	2250	2250	mA
Auto Refresh Current	I <sub>DD5</sub>	T <sub>RC</sub> =T <sub>RC</sub> (MIN)	3375	3015	3015	mA
Self Refresh Current	I <sub>DD6</sub>	CKE ≤ 0.2V	72	72	72	mA
Operating Current	I <sub>DD7A</sub>	Four bank interleaving Reads (BL=4) with auto precharge with T <sub>RC</sub> =T <sub>RC</sub> (MIN); T <sub>CK</sub> =T <sub>CK</sub> (MIN); Address and control inputs change only during Active Read or Write commands	4770	4050	4050	mA

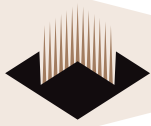

**DETAILED TEST CONDITIONS FOR DDR SDRAM I<sub>DD1</sub> & I<sub>DD7A</sub>**

**I<sub>DD1</sub> : OPERATING CURRENT : ONE BANK**

1. Typical Case :  $V_{CC}=2.5V$ ,  $T=25^{\circ}C$
2. Worst Case :  $V_{CC}=2.7V$ ,  $T=10^{\circ}C$
3. Only one bank is accessed with  $t_{RC}$  (min), Burst Mode, Address and Control inputs on NOP edge are changing once per clock cycle.  $I_{OUT} = 0mA$
4. Timing Patterns :
  - DDR200 (100 MHz, CL=2) :  $t_{CK}=10ns$ , CL2, BL=4,  $t_{RCD}=2*t_{CK}$ ,  $t_{RAS}=5*t_{CK}$   
Read : A0 N R0 N N P0 N A0 N - repeat the same timing with random address changing; 50% of data changing at every burst
  - DDR266 (133MHz, CL=2.5) :  $t_{CK}=7.5ns$ , CL=2.5, BL=4,  $t_{RCD}=3*t_{CK}$ ,  $t_{RC}=9*t_{CK}$ ,  $t_{RAS}=5*t_{CK}$   
Read : A0 N N R0 N P0 N N A0 N - repeat the same timing with random address changing; 50% of data changing at every burst
  - DDR266 (133MHz, CL=2) :  $t_{CK}=7.5ns$ , CL=2, BL=4,  $t_{RCD}=3*t_{CK}$ ,  $t_{RC}=9*t_{CK}$ ,  $t_{RAS}=5*t_{CK}$   
Read : A0 N N R0 N P0 N N A0 N - repeat the same timing with random address changing; 50% of data changing at every burst
  - DDR333 (166MHz, CL=2.5) :  $t_{CK}=6ns$ , BL=4,  $t_{RCD}=10*t_{CK}$ ,  $t_{RAS}=7*t_{CK}$   
Read : A0 N N R0 N P0 N N A0 N - repeat the same timing with random address changing; 50% of data changing at every burst

**I<sub>DD7A</sub> : OPERATING CURRENT : FOUR BANKS**

1. Typical Case :  $V_{CC}=2.5V$ ,  $T=25^{\circ}C$
2. Worst Case :  $V_{CC}=2.7V$ ,  $T=10^{\circ}C$
3. Four banks are being interleaved with  $t_{RC}$  (min), Burst Mode, Address and Control inputs on NOP edge are not changing.  $I_{OUT}=0mA$
4. Timing Patterns :
  - DDR200 (100 MHz, CL=2) :  $t_{CK}=10ns$ , CL2, BL=4,  $t_{RRD}=2*t_{CK}$ ,  $t_{RCD}=3*t_{CK}$ , Read with Autoprecharge  
Read : A0 N A1 R0 A2 R1 A3 R2 A0 R3 A1 R0 - repeat the same timing with random address changing; 100% of data changing at every burst
  - DDR266 (133MHz, CL=2.5) :  $t_{CK}=7.5ns$ , CL=2.5, BL=4,  $t_{RRD}=3*t_{CK}$ ,  $t_{RCD}=3*t_{CK}$   
Read with Autoprecharge  
Read : A0 N A1 R0 A2 R1 A3 R2 N R3 A0 N A1 R0 - repeat the same timing with random address changing; 100% of data changing at every burst
  - DDR266 (133MHz, CL=2) :  $t_{CK}=7.5ns$ , CL2=2, BL=4,  $t_{RRD}=2*t_{CK}$ ,  $t_{RCD}=2*t_{CK}$   
Read : A0 N A1 R0 A2 R1 A3 R2 N R3 A0 N A1 R0 - repeat the same timing with random address changing; 100% of data changing at every burst
  - DDR333 (166MHz, CL=2.5) :  $t_{CK}=6ns$ , BL=4,  $t_{RRD}=3*t_{CK}$ ,  $t_{RCD}=3*t_{CK}$ , Read with Autoprecharge  
Read : A0 N A1 R0 A2 R1 A3 R2 N R3 A0 N A1 R0 - repeat the same timing with random address changing; 100% of data changing at every burst

Legend : A = Activate, R = Read, W = Write, P = Precharge, N = NOP

A (0-3) = Activate Bank 0-3

R (0-3) = Read Bank 0-3

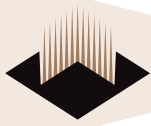

**DDR SDRAM COMPONENT ELECTRICAL CHARACTERISTICS AND RECOMMENDED AC OPERATING CONDITIONS**

AC CHARACTERISTICS		335		262		265		202				
PARAMETER	SYMBOL	MIN	MAX	MIN	MAX	MIN	MAX	MIN	MAX	UNITS	NOTES	
Access window of DQs from CK/CK#	t <sub>AC</sub>	-0.7	+0.7	+0.75	-0.75	+0.75	-0.75	+0.75	-0.75	ns		
CK high-level width	t <sub>CH</sub>	0.45	0.55	0.45	0.55	0.45	0.55	0.45	0.55	t <sub>CK</sub>	25	
CK low-level width	t <sub>CL</sub>	0.45	0.55	0.45	0.55	0.45	0.55	0.45	0.55	t <sub>CK</sub>	25	
Clock cycle time	CL = 2.5	t <sub>CK(2.5)</sub>	7.6	13	10	13	10	13	10	13	ns	37, 42
	CL = 2	t <sub>CK(2)</sub>	7.5	13	7.5	13	7.5	13	7.5	13	ns	41
DQ and DM input hold time relative to DQS	t <sub>DH</sub>	0.45								ns	22, 26	
DQ and DM input setup time relative to DQS	t <sub>DS</sub>	0.45								ns	22, 26	
DQ and DM input pulse width (for each input)	t <sub>DIPW</sub>	1.75								ns	26	
Access window of DQS from CK/CK#	t <sub>DQSCK</sub>	-0.60	+0.60	+0.8		+0.8		+0.8		ns		
DQS input high pulse width	t <sub>DQSH</sub>	0.35								t <sub>CK</sub>		
DQS input low pulse width	t <sub>DQSL</sub>	0.35								t <sub>CK</sub>		
DQS-DQ skew, DQS to last DQ valid, per group, per access	t <sub>DQSQ</sub>		0.45		0.6		0.6		0.6	ns	22	
Write command to first DQS latching transition	t <sub>DQSS</sub>	0.75	1.25	0.75	1.25	0.75	1.25	0.75	1.25	t <sub>CK</sub>		
DQS falling edge to CK rising - setup time	t <sub>DSS</sub>	0.2		0.2		0.2		0.2		t <sub>CK</sub>		
DQS falling edge from CK rising - hold time	t <sub>DSH</sub>	0.2		0.2		0.2		0.2		t <sub>CK</sub>		
Half clock period	t <sub>HP</sub>	t <sub>CH,tCL</sub>		t <sub>CH,tCL</sub>		t <sub>CH,tCL</sub>		t <sub>CH,tCL</sub>		ns	29	
Data-out high-impedance window from CK/CK#	t <sub>HZ</sub>		+0.70		+0.8		+0.8		+0.8	ns	16, 36	
Data-out low-impedance window from CK/CK#	t <sub>LZ</sub>	-0.70		-0.8		-0.8		-0.8		ns	16, 36	
Address and control input hold time (1 V/ns)	t <sub>HF</sub>	0.75		ns	12	ns	12	ns	12	ns	12	
Address and control input setup time (1 V/ns)	t <sub>SF</sub>	0.75		1.1		1.1		1.1		ns	12	
Address and control input hold time (0.5 V/ns)	t <sub>HS</sub>	0.80		1.1		1.1		1.1		ns	12	
Address and control input setup time (0.5 V/ns)	t <sub>SS</sub>	0.80		1.1		1.1		1.1		ns	12	
Address and Control input pulse width (for each input)	t <sub>PW</sub>	2.2		2.2		2.2		2.2		ns		
LOAD MODE REGISTER command cycle time	t <sub>MRD</sub>	12		16		16		16		ns		
DQ-DQS hold, DQS to first DQ to go non-valid, per access	t <sub>QH</sub>	t <sub>HP</sub> - t <sub>QHS</sub>		t <sub>HP</sub> - t <sub>QHS</sub>		t <sub>HP</sub> - t <sub>QHS</sub>		t <sub>HP</sub> - t <sub>QHS</sub>		ns	22	
Data hold skew factor	t <sub>QHS</sub>		0.55		1		1		1	ns		
ACTIVE to PRECHARGE command	t <sub>RAS</sub>	42	70,000	40	120,000	40	120,000	40	120,000	ns	30	
ACTIVE to READ with Auto precharge command	t <sub>RAP</sub>	15		20		20		20		ns		
ACTIVE to ACTIVE/AUTO REFRESH command period	t <sub>RC</sub>	60		70		70		70		ns		
AUTO REFRESH command period	t <sub>RFC</sub>	72		75		75		75		ns	40	
ACTIVE to READ or WRITE delay	t <sub>RCD</sub>	15		20		20		20		ns		
PRECHARGE command period	t <sub>RP</sub>	15		20		20		20		ns		
DQS read preamble	t <sub>RPRE</sub>	0.9	1.1	0.9	1.1	0.9	1.1	0.9	1.1	t <sub>CK</sub>		
DQS read postamble	t <sub>RPST</sub>	0.4	0.6	0.4	0.6	0.4	0.6	0.4	0.6	t <sub>CK</sub>		
ACTIVE bank a to ACTIVE bank b command	t <sub>RRD</sub>	12		15		15		15		ns		
DQS write preamble	t <sub>WPRE</sub>	0.25		0.25		0.25		0.25		t <sub>CK</sub>		
DQS write preamble setup time	t <sub>WPRES</sub>	0		0		0		0		ns	17, 19	

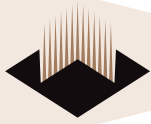

**DDR SDRAM COMPONENT ELECTRICAL CHARACTERISTICS AND RECOMMENDED AC  
OPERATING CONDITIONS (Continued)**

AC CHARACTERISTICS		335		262		265		202			
PARAMETER	SYMBOL	MIN	MAX	MIN	MAX	MIN	MAX	MIN	MAX	UNITS	NOTES
DQS write postamble	t <sub>WPST</sub>	0.4	0.6	0.4	0.6	0.4	0.6	0.4	0.6	t <sub>CK</sub>	17
Write recovery time	t <sub>WR</sub>	15		15		15		15		ns	
Internal WRITE to READ command delay	t <sub>WTR</sub>	1		1		1		1		t <sub>CK</sub>	
Data valid output window	na	t <sub>QH</sub> - t <sub>DQSQ</sub>		t <sub>QH</sub> - t <sub>DQSQ</sub>		t <sub>QH</sub> - t <sub>DQSQ</sub>		t <sub>QH</sub> - t <sub>DQSQ</sub>		ns	22
REFRESH to REFRESH command interval	t <sub>REFC</sub>		70.3		70.3		70.3		70.3	μs	21
Average periodic refresh interval	t <sub>REFI</sub>		7.8		7.8		7.8		7.8	μs	21
Terminating voltage delay to V <sub>CC</sub>	t <sub>VTD</sub>	0		0		0		0		ns	
Exit SELF REFRESH to non-READ command	t <sub>XSNR</sub>	75		75		75		75		ns	
Exit SELF REFRESH to READ command	t <sub>XSRD</sub>	200		200		200		200		t <sub>CK</sub>	



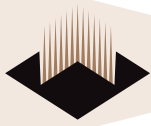

## Notes

1. All voltages referenced to  $V_{SS}$ .
2. Tests for AC timing,  $I_{DD}$ , and electrical AC and DC characteristics may be conducted at nominal reference/supply voltage levels, but the related specifications and device operation are guaranteed for the full voltage range specified.
3. Outputs (except for  $I_{DD}$  measurements) measured with equivalent load:

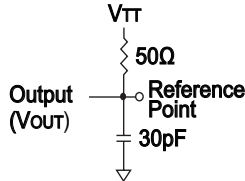

4. AC timing and  $I_{DD}$  tests may use a  $V_{IL}$ -to- $V_{IH}$  swing of up to 1.5V in the test environment, but input timing is still referenced to  $V_{REF}$  (or to the crossing point for CK/CK#), and parameter specifications are guaranteed for the specified AC input levels under normal use conditions. The minimum slew rate for the input signals used to test the device is 1 V/ns in the range between  $V_{IL}(AC)$  and  $V_{IH}(AC)$ .
5. The AC and DC input level specifications are as defined in the SSTL\_2 standard (i.e., the receiver will effectively switch as a result of the signal crossing the AC input level and will remain in that state as long as the signal does not ring back above [below] the DC input LOW [HIGH] level).
6.  $V_{REF}$  is expected to equal  $V_{CC2}$  of the transmitting device and to track variations in the DC level of the same. Peak-to-peak noise (noncommon mode) on  $V_{REF}$  may not exceed  $\pm 2$  percent of the DC value. Thus, from  $V_{CC2}$ ,  $V_{REF}$  is allowed  $\pm 25mV$  for DC error and an additional  $\pm 25mV$  for AC noise. This measurement is to be taken at the nearest  $V_{REF}$  bypass capacitor.
7.  $V_{TT}$  is not applied directly to the device.  $V_{TT}$ , a system supply for signal termination resistors, is expected to be set equal to  $V_{REF}$  and must track variations in the DC level of  $V_{REF}$ .
8.  $V_{ID}$  is the magnitude of the difference between the input level on CK and the input level on CK#.
9. The value of  $V_{IX}$  and  $V_{MP}$  are expected to equal  $V_{CC2}$  of the transmitting device and must track variations in the DC level of the same.
10.  $I_{DD}$  is dependent on output loading and cycle rates. Specified values are obtained with minimum cycle times at  $CL = 2.5$  for 335, and  $CL = 2$  for 262, 265 and 202 speeds with the outputs open.
11. Enables on-chip refresh and address counters.
12.  $I_{DD}$  specifications are tested after the device is properly initialized and is averaged at the defined cycle rate.
13. This parameter is sampled.  $V_{CC} = +2.5V \pm 0.2V$ ,  $V_{CC} = +2.5V \pm 0.2V$ ,  $V_{REF} = V_{SS}$ ,  $f = 100$  MHz,  $T_A = 25^\circ C$ ,  $V_{OUT}(DC) = V_{CC2}$ ,  $V_{OUT}(peak\ to\ peak) = 0.2V$ . DM input is grouped with I/O pins, reflecting that they are matched in loading.
14. For slew rates  $< 1$  V/ns and  $\geq 0.5$  V/ns. If slew rate is less than 0.5 V/ns, timing must be derated;  $t_{IS}$  has an additional 50ps per each 100mV/ns reduction in slew rate from the 500mV/ns, while  $t_{IH}$  is unaffected. If the slew rate exceeds 4.5 V/ns, functionality is uncertain. For 335, slew rates must be greater than or equal to 0.5V/ns.
15. The CK/CK# input reference level (for timing referenced to CK/CK#) is the point at which CK and CK# cross; the input reference level for signals other than CK/CK# is  $V_{REF}$ .
16. Inputs are not recognized as valid until  $V_{REF}$  stabilizes. Once initialized, including Self-Refresh mode,  $V_{REF}$  must be powered within the specified range. Exception: during the period before  $V_{REF}$  stabilizes,  $CKE = 0.3 \times V_{CC}$  is recognized as LOW.
17. The output timing reference level, as measured at the timing reference point indicated in Note 3, is  $V_{TT}$ .

18.  $t_{HZ}$  and  $t_{LZ}$  transitions occur in the same access time windows as data valid transitions. These parameters are not referenced to a specific voltage level, but specify when the device output is no longer driving (HZ) or begins driving (LZ).
19. The intent of the "Don't Care" state after completion of the postamble is that the DQS-driven signal should either be HIGH, LOW, or High-Z and that any signal transition within the input switching region must follow valid input requirements. If DQS transitions HIGH, above DC  $V_{IH}$  (MIN) then it must not transition LOW, below DC  $V_{IH}$ , prior to  $t_{BOSS}$  (MIN).
20. This is not a device limit. The device will operate with a negative value, but system performance could be degraded due to bus turnaround.
21. It is recommended that DQS be valid (HIGH or LOW) on or before the WRITE command. The case shown (DQS going from High-Z to logic LOW) applies when no WRITES were previously in progress on the bus. If a previous WRITE was in progress, DQS could be HIGH during this time, depending on  $t_{BOSS}$ .
22.  $t_{RC}$  (MIN) or  $t_{RFC}$  (MIN) is the smallest multiple of  $t_{CK}$  that meets the minimum absolute value for the respective parameter.  $t_{RAS}$  (MAX) for  $I_{DD}$  measurements is the largest multiple of  $t_{CK}$  that meets the maximum absolute value for  $t_{RAS}$ .
23. The refresh period is 64ms. This equates to an average refresh rate of 7.8125 $\mu s$ . However, an AUTO REFRESH command must be asserted at least once every 70.3 $\mu s$ ; burst refreshing or posting by the DRAM controller greater than eight refresh cycles is not allowed.
24. The I/O capacitance per DQS and DQ byte/group will not differ by more than this maximum amount for any given device.
25. The data valid window is derived by achieving other specifications:  $t_{HP}$  ( $t_{CK2}$ ),  $t_{BOSS}$ , and  $t_{QH}$  ( $t_{QH} = t_{HP} - t_{QHS}$ ). The data valid window derates in direct proportion to the clock duty cycle and a practical data valid window can be derived. The clock is allowed a maximum duty-cycle variation of 45/55, because functionality is uncertain when operating beyond a 45/55 ratio.
26. Referenced to each output group: x4 = DQS with DQ0-DQ3; x8 = DQS with DQ0-DQ7; x16 = LDQS with DQ0-DQ7; and UDQS with DQ8-DQ15.
27. This limit is actually a nominal value and does not result in a fail value.  $CKE$  is HIGH during REFRESH command period ( $t_{RFC}$  [MIN]) else  $CKE$  is LOW (i.e., during standby).
28. To maintain a valid level, the transitioning edge of the input must:
  - a. Sustain a constant slew rate from the current AC level through to the target AC level,  $V_{IL}(AC)$  or  $V_{IH}(AC)$ .
  - b. Reach at least the target AC level.
  - c. After the AC target level is reached, continue to maintain at least the target DC level,  $V_{IL}(DC)$  or  $V_{IH}(DC)$ .
29. The Input capacitance per pin group will not differ by more than this maximum amount for any given device.
30. CK and CK# input slew rate must be  $\geq 1V/ns$  ( $\geq 2V/ns$  if measured differentially).
31. DQ and DM input slew rates must not deviate from DQS by more than 10 percent. If the DQ/DM/DQS slew rate is less than 0.5 V/ns, timing must be derated: 50ps must be added to  $t_{DS}$  and  $t_{DH}$  for each 0.1 V/ns reduction in slew rate. For 335 speed grades, slew rate must be  $\geq 0.5$  V/ns. If slew rate exceeds 4 V/ns, functionality is uncertain.
32.  $V_{CC}$  must not vary more than four percent if  $CKE$  is not active while any bank is active.
33. The clock is allowed up to  $\pm 150ps$  of jitter. Each timing parameter is allowed to vary by the same amount.
34.  $t_{HP}$  (MIN) is the lesser of  $t_{CL}$  minimum and  $t_{CH}$  minimum actually applied to the device CK and CK# inputs, collectively during bank active.
35. READs and WRITEs with auto precharge are not allowed to be issued until  $t_{RAS}$  (MIN) can be satisfied prior to the internal PRECHARGE command being issued.



36. Any positive glitch must be less than 1/3 of the clock cycle and not more than +400mV or 2.9V. Any negative glitch must be less than 1/3 of the clock cycle and not exceed either -300mV or 2.2V.
37. The voltage levels used are derived from a minimum  $V_{CC}$  level and the referenced test load. In practice, the voltage levels obtained from a properly terminated bus will provide significantly different voltage values.
38.  $V_{IH}$  overshoot:  $V_{IH} (MAX) = V_{CC} + 1.5V$  for a pulse width  $\leq 3ns$  and the pulse width can not be greater than 1/3 of the cycle rate.  $V_{IL}$  under-shoot:  $V_{IL} (MIN) = -1.5V$  for a pulse width  $\leq 3ns$  and the pulse width can not be greater than 1/3 of the cycle rate.
39.  $V_{CC}$  and  $V_{CC}$  must track each other.
40.  $t_{HZ} (MAX)$  will prevail over  $t_{BOSCK} (MAX) + t_{RPST} (MAX)$  condition.  $t_{LZ} (MIN)$  will prevail over  $t_{BOSCK} (MIN) + t_{RPRE} (MAX)$  condition.
41.  $t_{RPST}$  end point and  $t_{RPRE}$  begin point are not referenced to a specific voltage level but specify when the device output is no longer driving ( $t_{RPST}$ ), or begins driving ( $t_{RPRE}$ ).
42. During initialization,  $V_{CC}$ ,  $V_{TT}$ , and  $V_{REF}$  must be equal to or less than  $V_{CC} + 0.3V$ . Alternatively,  $V_{TT}$  may be 1.35V maximum during power-up, even if  $V_{CC}/V_{CC}$  are 0V, provided a minimum of 42 $\Omega$  of series resistance is used between the  $V_{TT}$  supply and the input pin.
43. The current part operates below the slowest JEDEC operating frequency of 83 MHz. As such, future die may not reflect this option.
44. When an input signal is indicated to be HIGH or LOW, it is defined as a steady state logic HIGH or LOW.
45. Random addressing changing; 50 percent of data changing at every transfer.
46. Random addressing changing; 100 percent of data changing at every transfer.
47. CKE must be active (HIGH) during the entire time a refresh command is executed. That is, from the time the AUTO REFRESH command is registered, CKE must be active at each rising clock edge, until tRFC has been satisfied.
48.  $I_{DD2N}$  specifies the DQ, DQS and DM to be driven to a valid HIGH or LOW logic level.  $I_{DD2Q}$  is similar to  $I_{DD2F}$  except  $I_{DD2Q}$  specifies the address and control inputs to remain stable. Although  $I_{DD2F}$ ,  $I_{DD2N}$ , and  $I_{DD2Q}$  are similar,  $I_{DD2F}$  is "worst case."
49. Whenever the operating frequency is altered, not including jitter, the DLL is required to be reset followed by 200 clock cycles before any READ command.
50. This is the DC voltage supplied at the DRAM and is inclusive of all noise up to 20 MHz. Any noise above 20 MHz at the DRAM generated from any source other than that of the DRAM itself may not exceed the DC voltage range of  $2.6V \pm 100mV$ .
51. The 335 speed grades will operate with  $t_{RAS}(min) = 40ns$  and  $t_{RAS}(max) = 120,000ns$  at any slower frequency.



ORDERING INFORMATION FOR BD4

Part Number	Speed	Height*
W3EG7264S335BD4	166MHz/333Mbps, CL=2.5	31.75 (1.25")
W3EG7264S262BD4	133MHz/266Mbps, CL=2	31.75 (1.25")
W3EG7264S265BD4	133MHz/266Mbps, CL=2.5	31.75 (1.25")
W3EG7264S202BD4	100MHz/200Mbps, CL=2	31.75 (1.25")

- NOTES:
- Consult Factory for availability of RoHS compliant products. (G = RoHS Compliant)
  - Vendor specific part numbers are used to provide memory components source control. The place holder for this is shown as lower case "x" in the part numbers above and is to be replaced with the respective vendors code. Consult factory for qualified sourcing options. (M = Micron, S = Samsung & consult factory for others)
  - Consult factory for availability of industrial temperature (-40°C to 85°C) option

PACKAGE DIMENSIONS FOR BD4

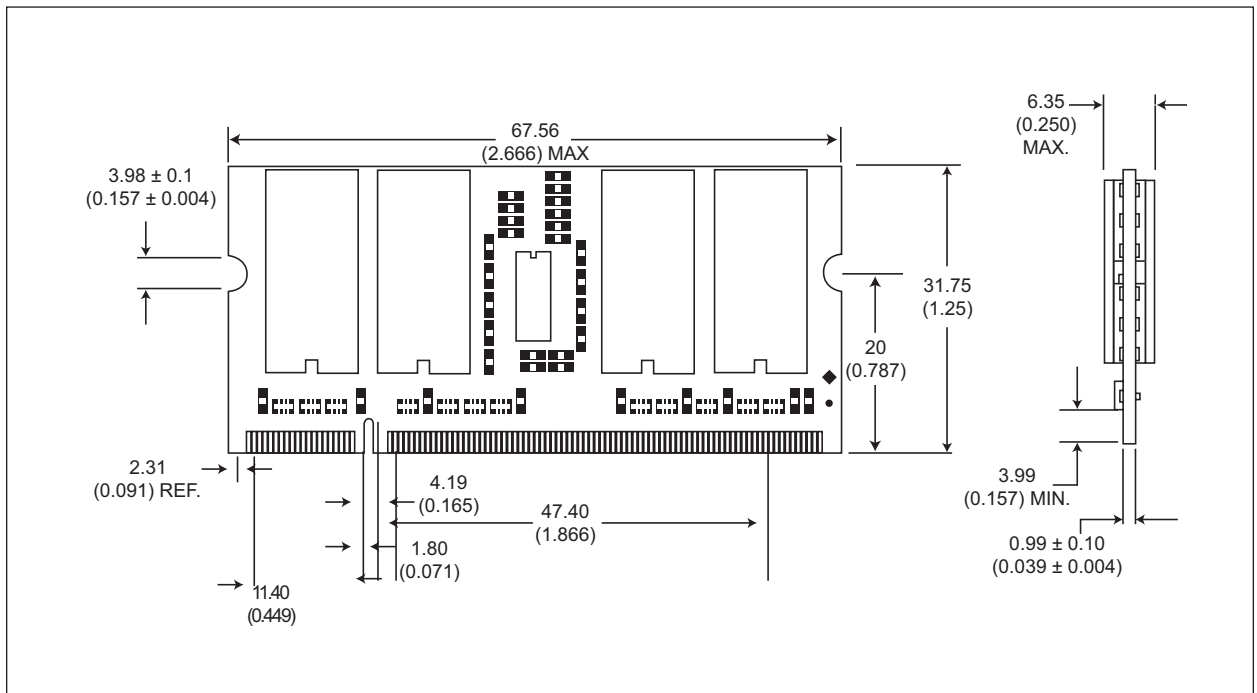

\* ALL DIMENSIONS ARE IN MILLIMETERS AND (INCHES)



ORDERING INFORMATION FOR AD4

Part Number	Speed	Height*
W3EG7264S335AD4	166MHz/333Mbps, CL=2.5	35.05 (1.38")
W3EG7264S262AD4	133MHz/266Mbps, CL=2	35.05 (1.38")
W3EG7264S265AD4	133MHz/266Mbps, CL=2.5	35.05 (1.38")
W3EG7264S202AD4	100MHz/200Mbps, CL=2	35.05 (1.38")

- NOTES:
- Consult Factory for availability of RoHS compliant products. (G = RoHS Compliant)
  - Vendor specific part numbers are used to provide memory components source control. The place holder for this is shown as lower case "x" in the part numbers above and is to be replaced with the respective vendors code. Consult factory for qualified sourcing options. (M = Micron, S = Samsung & consult factory for others)
  - Consult factory for availability of industrial temperature (-40°C to 85°C) option

PACKAGE DIMENSIONS FOR AD4

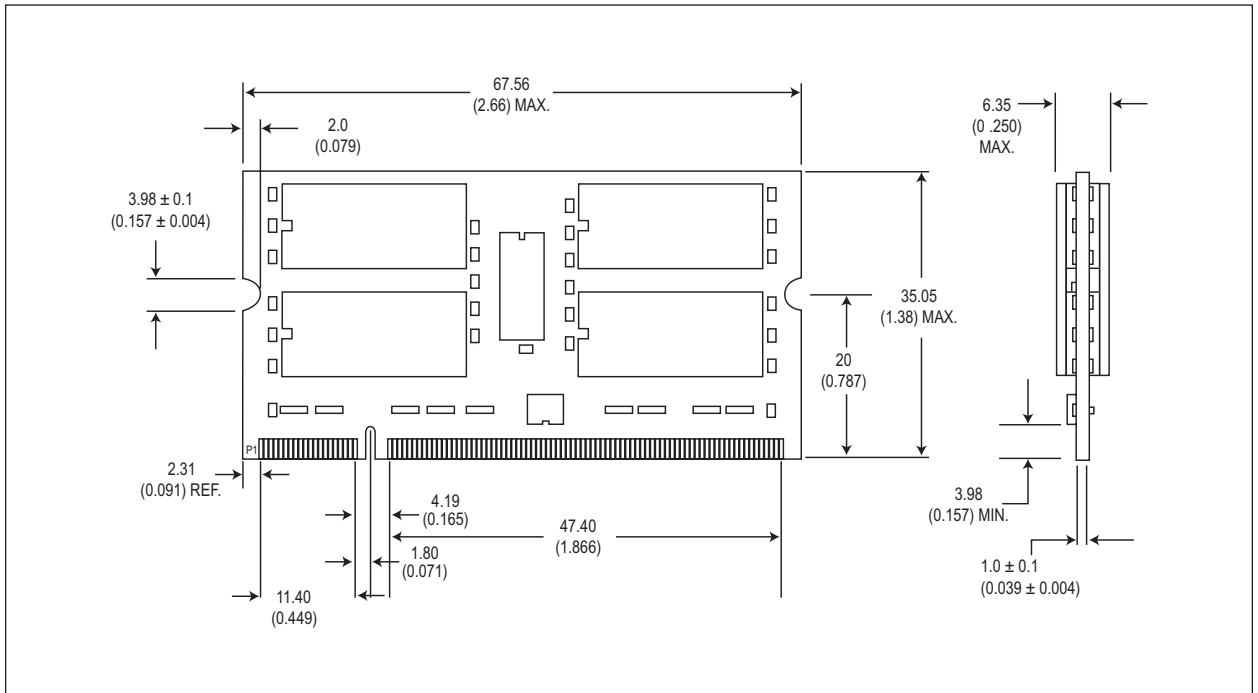

\* ALL DIMENSIONS ARE IN MILLIMETERS AND (INCHES)

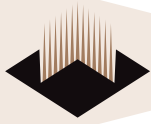

### Document Title

512MB – 2x32Mx72 DDR ECC SDRAM UNBUFFERED w/PLL

### Revision History

Rev #	History	Release Date	Status
Rev 0	Created	8-1-03	Advanced
Rev 1	1.1 Added "BD4" package option 1.2 Updated CAP and IDD specs 1.3 Removed "ED" from part number 1.4 Changed datasheet from Advanced to Preliminary	6-04	Preliminary
Rev 2	2.1 Added AC Specs	10-04	Preliminary
Rev 3	3.1 Added lead-free and RoHS notes 3.2 Added source control notes 3.2 Added industrial temperature option	1-05	Preliminary