

34.0-46.0 GHz GaAs MMIC Image Reject Mixer

Features

- X Fundamental Image Reject Mixer
- X 7.0 dB Conversion Loss
- X 20.0 dB Image Rejection
- X +24 dBm Input Third Order Intercept
- X 100% On-Wafer RF Testing
- X 100% Visual Inspection to MIL-STD-883 Method 2010

General Description

Mimix Broadband's 34.0-46.0 GHz GaAs MMIC fundamental image reject mixer can be used as an up- or down-converter. The device has a conversion loss of 7.0 dB with a 20.0 dB image rejection across the band. I and Q mixer outputs are provided and an external 90 degree hybrid is required to select the desired sideband. This MMIC uses Mimix Broadband's 0.15 μm GaAs PHEMT device model technology, and is based upon electron beam lithography to ensure high repeatability and uniformity. The chip has surface passivation to protect and provide a rugged part with backside via holes and gold metallization to allow either a conductive epoxy or eutectic solder die attach process. This device is well suited for Millimeter-wave Point-to-Point Radio, LMDS, SATCOM and VSAT applications.

Chip Device Layout



Absolute Maximum Ratings

Gate Bias Voltage (Vg)	+0.3 VDC
Input Power (RF Pin)	+20.0 dBm
Input Power (IF Pin)	+20.0 dBm
Storage Temperature (Tstg)	-65 to +165 °C
Operating Temperature (Ta)	-55 to +125 °C

Electrical Characteristics (Ambient Temperature T = 25° C)

Parameter	Units	Min.	Typ.	Max.
Frequency Range (RF) Upper Side Band	GHz	34.0	-	46.0
Frequency Range (RF) Lower Side Band	GHz	34.0	-	46.0
Frequency Range (LO)	GHz	30.0	-	50.0
Frequency Range (IF)	GHz	DC	-	4.0
RF Return Loss (S11)	dB	-	18.0	-
IF Return Loss (S22)	dB	-	10.0	-
LO Return Loss (S33)	dB	-	8.0	-
Conversion Loss (S21)	dB	-	7.0	8.0
LO Input Drive (P _{LO})	dBm	-	+12.0	-
Image Rejection	dBc	15.0	20.0	-
Isolation LO/RF	dB	-	11.0	-
Isolation LO/IF	dB	-	30.0	-
Isolation RF/IF	dB	-	30.0	-
Input Third Order Intercept (IIP3)	dBm	-	+24.0	-
Gate Bias Voltage (Vg1)	VDC	-2.0	-0.5	+0.1

34.0-46.0 GHz GaAs MMIC Image Reject Mixer

Mixer Measurements

XM1002, USB Conversion Gain (6566 devices)

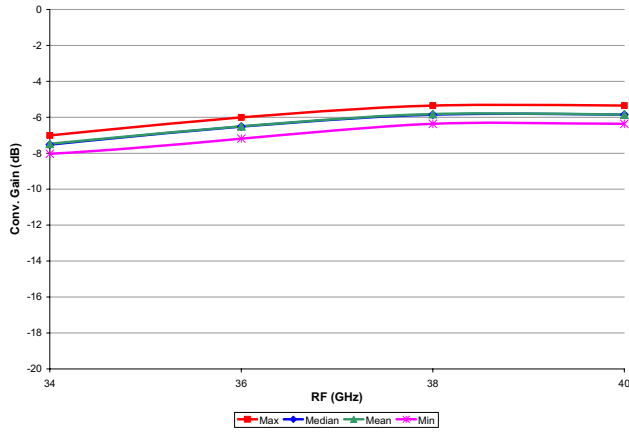

XM1002, USB Image Rejection (6566 devices)

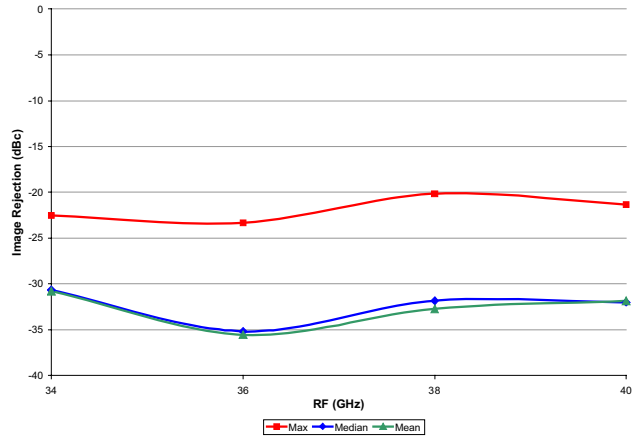

XM1002, LSB Conversion Gain (6566 devices)

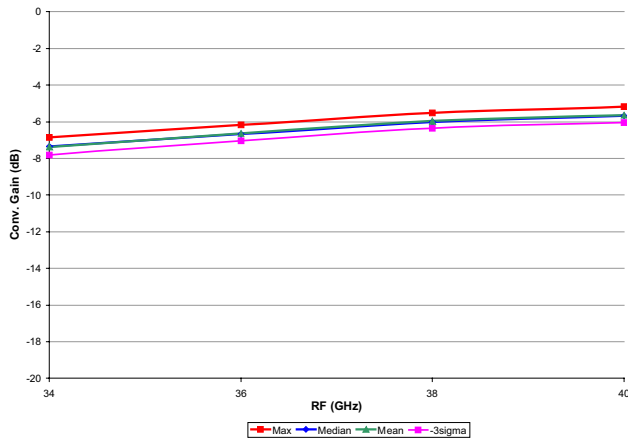

XM1002, LSB Image Rejection (6566 devices)

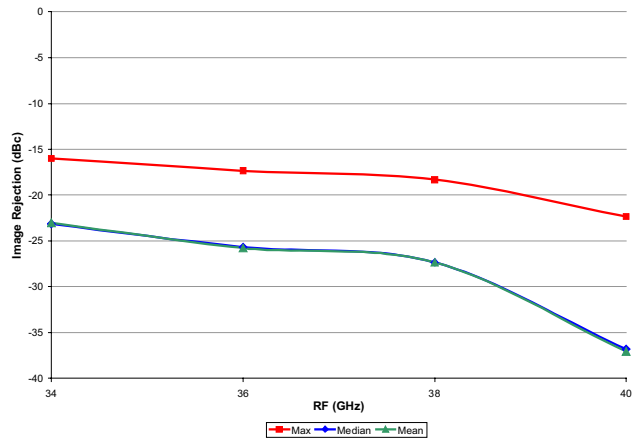

RF Return Loss (dB)

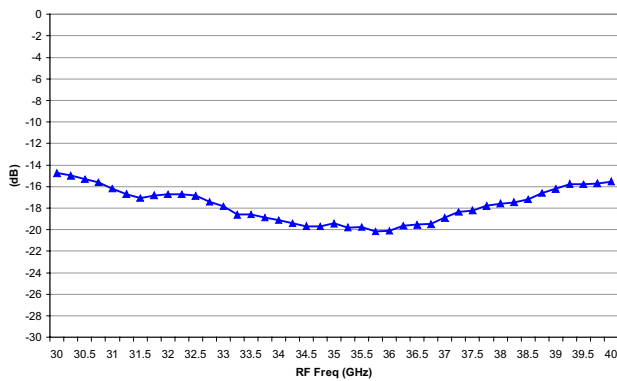

LO Return Loss (dB)

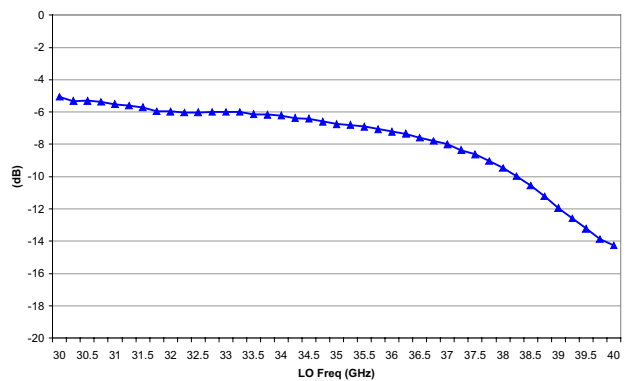

34.0-46.0 GHz GaAs MMIC Image Reject Mixer

Mixer Measurements (cont.)

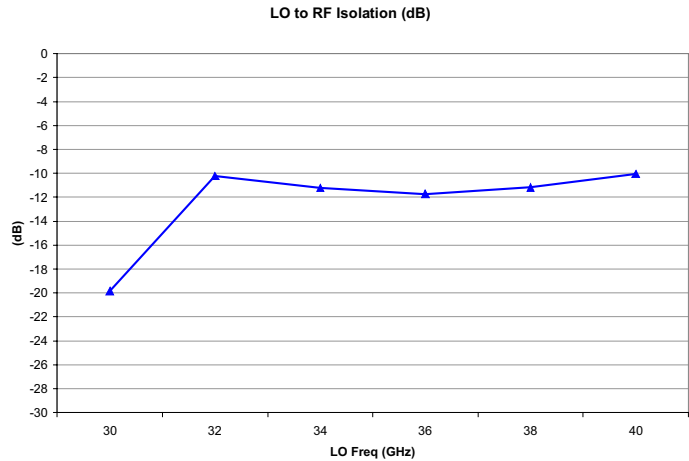

34.0-46.0 GHz GaAs MMIC Image Reject Mixer

Mixer Measurements (cont.)

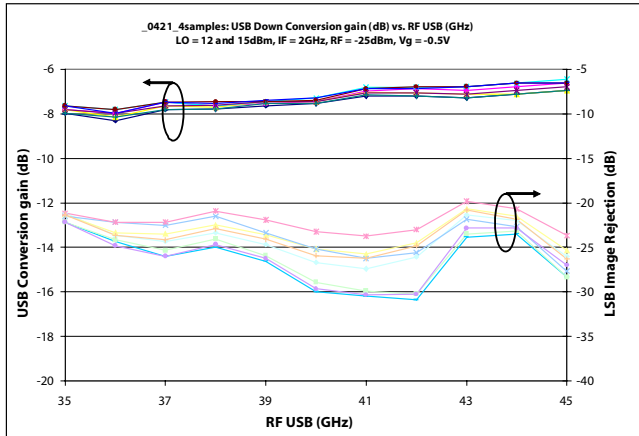

IF=2 GHz

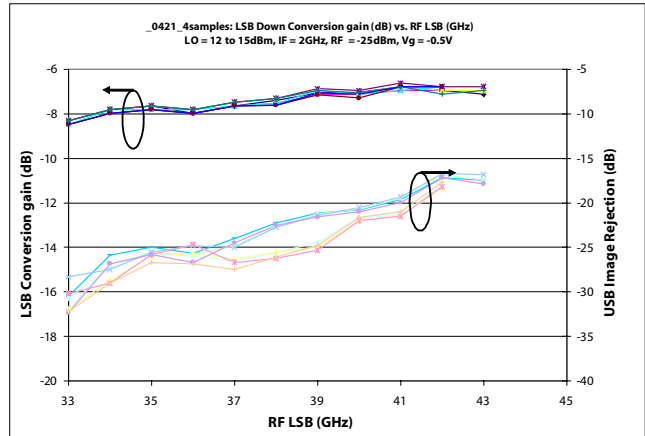

IF=2 GHz

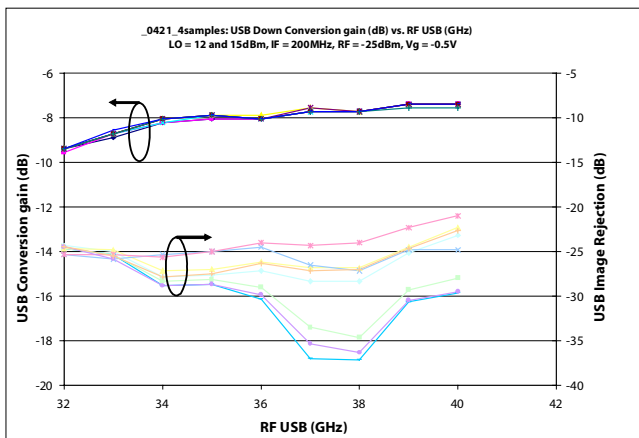

IF=200 MHz

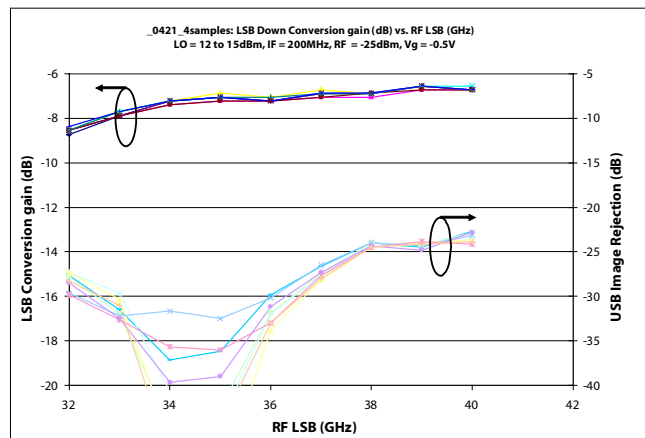

IF=200 MHz

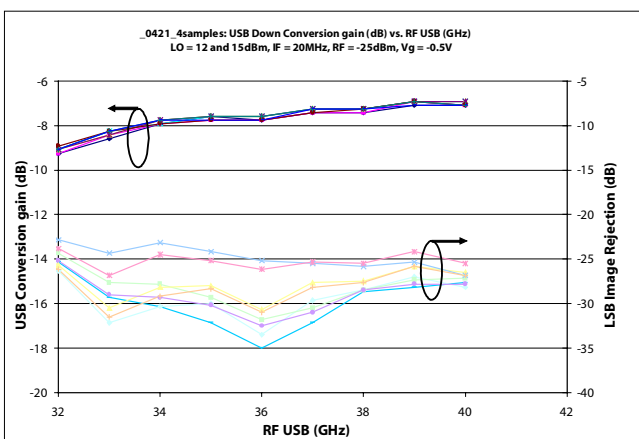

IF=20 MHz

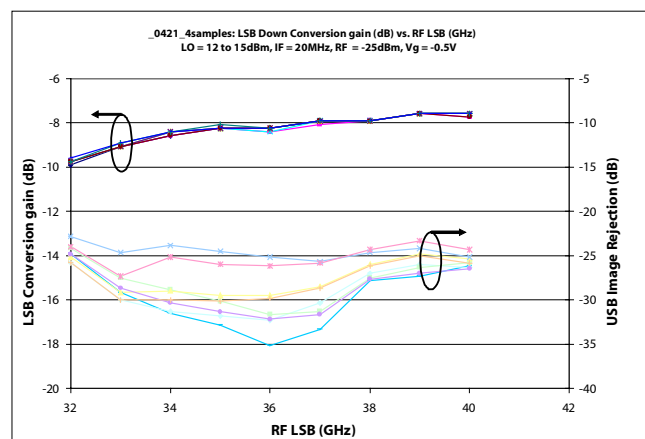

IF=20 MHz

34.0-46.0 GHz GaAs MMIC Image Reject Mixer

December 2005 - Rev 02-Dec-05

Mixer Measurements (cont.)

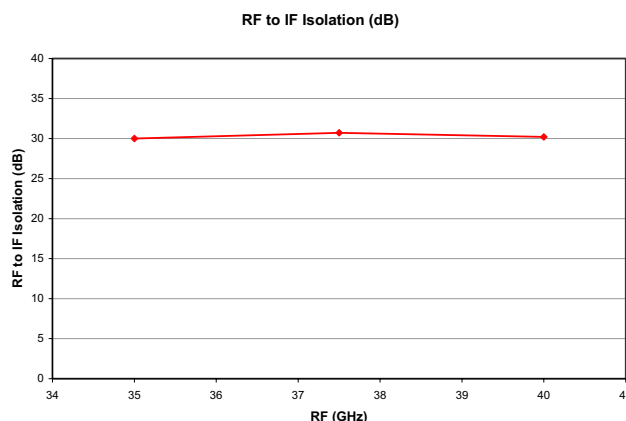
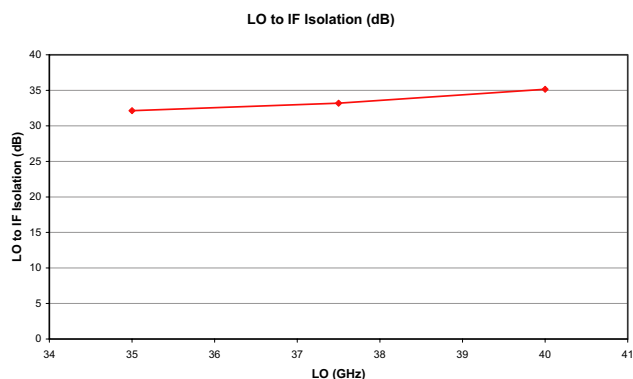
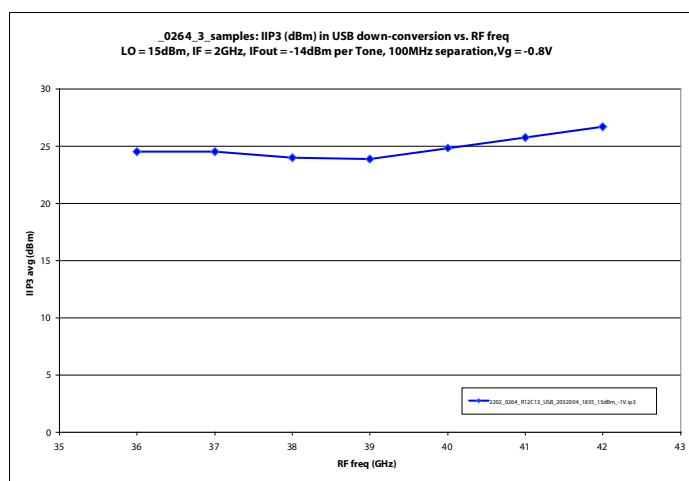
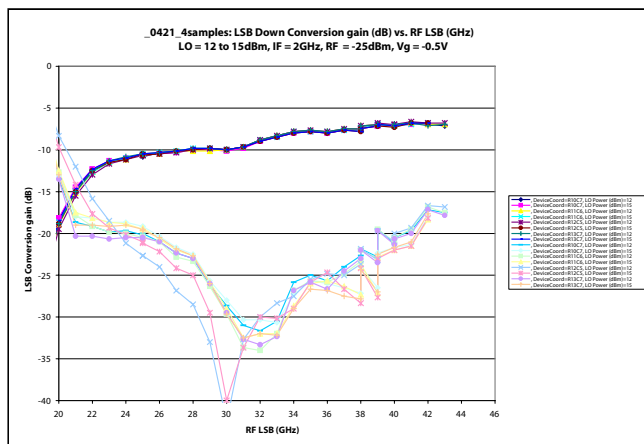
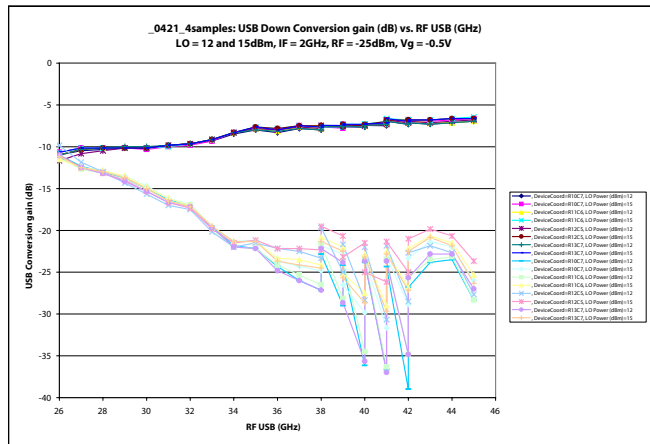

34.0-46.0 GHz GaAs MMIC Image Reject Mixer

Mechanical Drawing

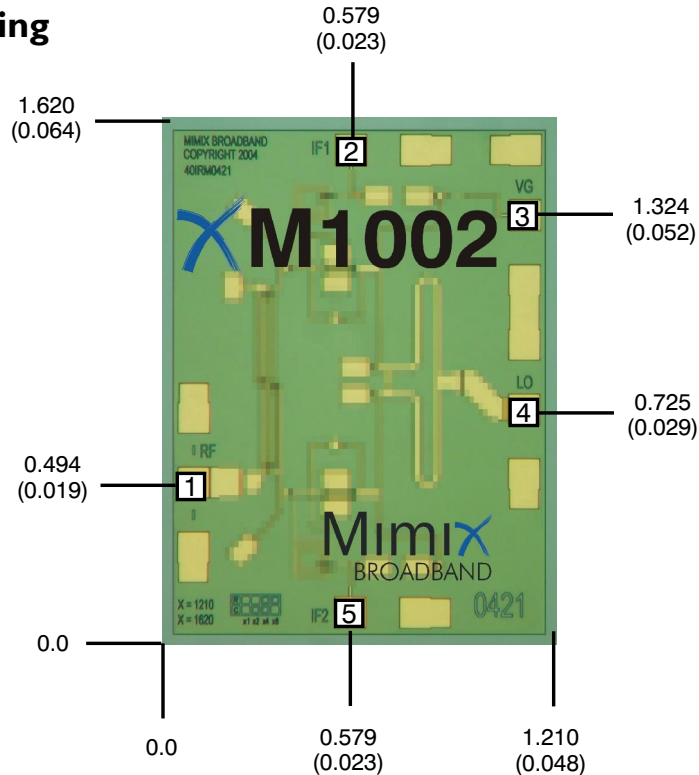

(Note: Engineering designator is 40IRM0421)

Units: millimeters (inches) Bond pad dimensions are shown to center of bond pad.
 Thickness: 0.110 +/- 0.010 (0.0043 +/- 0.0004), Backside is ground, Bond Pad/Backside Metallization: Gold
 All Bond Pads are 0.100 x 0.100 (0.004 x 0.004).

Bond pad centers are approximately 0.109 (0.004) from the edge of the chip.
 Dicing tolerance: +/- 0.005 (+/- 0.0002). Approximate weight: 1.215 mg.

Bond Pad #1 (RF) Bond Pad #3 (Vg) Bond Pad #5 (IF2)
 Bond Pad #2 (IF1) Bond Pad #4 (LO)

Bias Arrangement

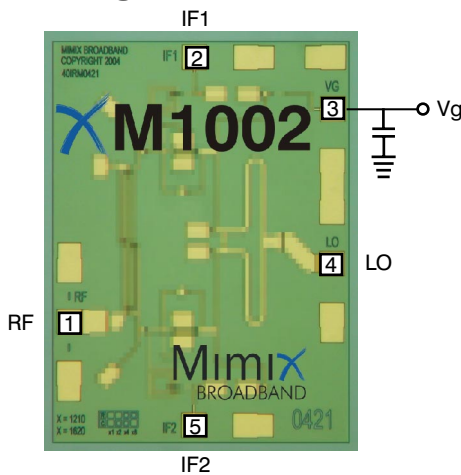

Bypass Capacitors - See App Note [2]

34.0-46.0 GHz GaAs MMIC Image Reject Mixer

December 2005 - Rev 02-Dec-05

App Note [1] Biasing - As shown in the bonding diagram, the pHEMT mixer devices are operated using a separate gate voltage V_{g1} . Set $V_{g1} = -0.5V$ for optimum conversion loss performance.

App Note [2] Bias Arrangement - Each DC pad (V_{g1}) needs to have DC bypass capacitance ($\sim 100-200$ pF) as close to the device as possible. Additional DC bypass capacitance (~ 0.01 uF) is also recommended.

App Note [3] USB/LSB Selection -

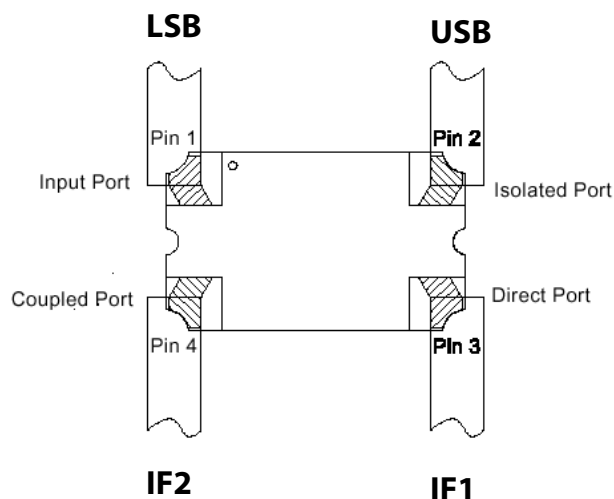

For Upper Side Band operation (USB):

With IF1 and IF2 connected to the direct port (0°) and coupled port (90°) respectively as shown in the diagram, the USB signal will reside on the isolated port. The input port must be loaded with 50 ohms.

For Lower Side Band operation (LSB):

With IF1 and IF2 connected to the direct port (0°) and coupled port (90°) respectively as shown in the diagram, the LSB signal will reside on the input port. The isolated port must be loaded with 50 ohms.

An alternate method of selection of USB or LSB:

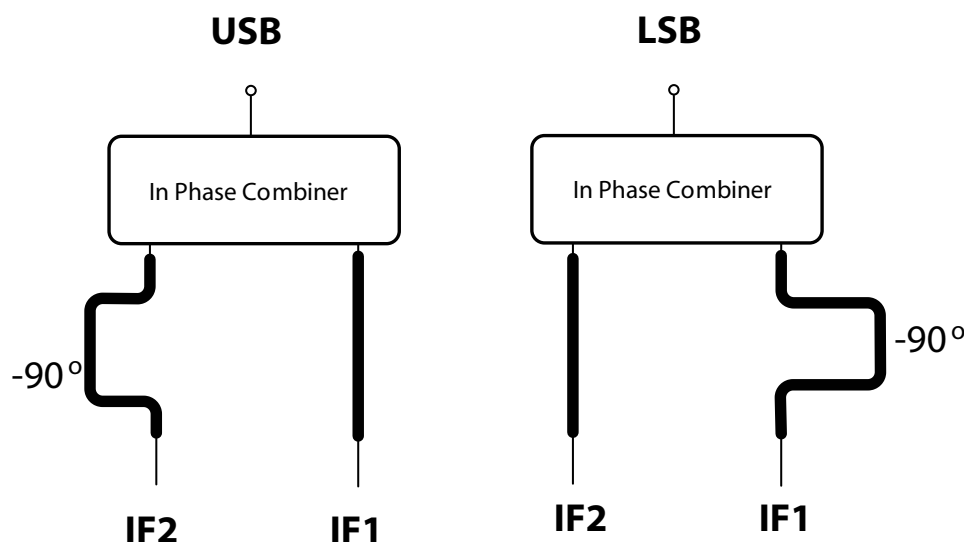

34.0-46.0 GHz GaAs MMIC Image Reject Mixer

December 2005 - Rev 02-Dec-05

Handling and Assembly Information

CAUTION! - Mimix Broadband MMIC Products contain gallium arsenide (GaAs) which can be hazardous to the human body and the environment. For safety, observe the following procedures:

- *Do not ingest.*
- *Do not alter the form of this product into a gas, powder, or liquid through burning, crushing, or chemical processing as these by-products are dangerous to the human body if inhaled, ingested, or swallowed.*
- *Observe government laws and company regulations when discarding this product. This product must be discarded in accordance with methods specified by applicable hazardous waste procedures.*

Life Support Policy - Mimix Broadband's products are not authorized for use as critical components in life support devices or systems without the express written approval of the President and General Counsel of Mimix Broadband. As used herein: (1) Life support devices or systems are devices or systems which, (a) are intended for surgical implant into the body, or (b) support or sustain life, and whose failure to perform when properly used in accordance with instructions for use provided in the labeling, can be reasonably expected to result in a significant injury to the user. (2) A critical component is any component of a life support device or system whose failure to perform can be reasonably expected to cause the failure of the life support device or system, or to affect its safety or effectiveness.

ESD - Gallium Arsenide (GaAs) devices are susceptible to electrostatic and mechanical damage. Die are supplied in antistatic containers, which should be opened in cleanroom conditions at an appropriately grounded anti-static workstation. Devices need careful handling using correctly designed collets, vacuum pickups or, with care, sharp tweezers.

Die Attachment - GaAs Products from Mimix Broadband are 0.100 mm (0.004") thick and have vias through to the backside to enable grounding to the circuit. Microstrip substrates should be brought as close to the die as possible. The mounting surface should be clean and flat. If using conductive epoxy, recommended epoxies are Ablestick 84-1LMI or 84-1LMIT cured in a nitrogen atmosphere per manufacturer's cure schedule. Apply epoxy sparingly to avoid getting any on to the top surface of the die. An epoxy fillet should be visible around the total die periphery. If eutectic mounting is preferred, then a fluxless gold-tin (AuSn) preform, approximately 0.001² thick, placed between the die and the attachment surface should be used. A die bonder that utilizes a heated collet and provides scrubbing action to ensure total wetting to prevent void formation in a nitrogen atmosphere is recommended. The gold-tin eutectic (80% Au 20% Sn) has a melting point of approximately 280°C (Note: Gold Germanium should be avoided). The work station temperature should be 310°C ± 10°C. Exposure to these extreme temperatures should be kept to minimum. The collet should be heated, and the die pre-heated to avoid excessive thermal shock. Avoidance of air bridges and force impact are critical during placement.

Wire Bonding - Windows in the surface passivation above the bond pads are provided to allow wire bonding to the die's gold bond pads. The recommended wire bonding procedure uses 0.076 mm x 0.013 mm (0.003" x 0.0005") 99.99% pure gold ribbon with 0.5-2% elongation to minimize RF port bond inductance. Gold 0.025 mm (0.001") diameter wedge or ball bonds are acceptable for DC Bias connections. Aluminum wire should be avoided. Thermo-compression bonding is recommended though thermosonic bonding may be used providing the ultrasonic content of the bond is minimized. Bond force, time and ultrasonics are all critical parameters. Bonds should be made from the bond pads on the die to the package or substrate. All bonds should be as short as possible.