

XP4654

Silicon NPN epitaxial planer transistor (Tr1)
 Silicon PNP epitaxial planer transistor (Tr2)

For high speed switching

■ Features

- Two elements incorporated into one package.
- Reduction of the mounting area and assembly cost by one half.

■ Basic Part Number of Element

- 2SC3757+2SA1738

■ Absolute Maximum Ratings (Ta=25°C)

	Parameter	Symbol	Ratings	Unit
Tr1	Collector to base voltage	V_{CBO}	40	V
	Collector to emitter voltage	V_{CES}	40	V
	Emitter to base voltage	V_{EBO}	5	V
	Collector current	I_C	100	mA
	Peak collector current	I_{CP}	300	mA
Tr2	Collector to base voltage	V_{CBO}	-15	V
	Collector to emitter voltage	V_{CES}	-15	V
	Emitter to base voltage	V_{EBO}	-4	V
	Collector current	I_C	-50	mA
	Peak collector current	I_{CP}	-100	mA
Overall	Total power dissipation	P_T	150	mW
	Junction temperature	T_j	150	°C
	Storage temperature	T_{stg}	-55 to +150	°C

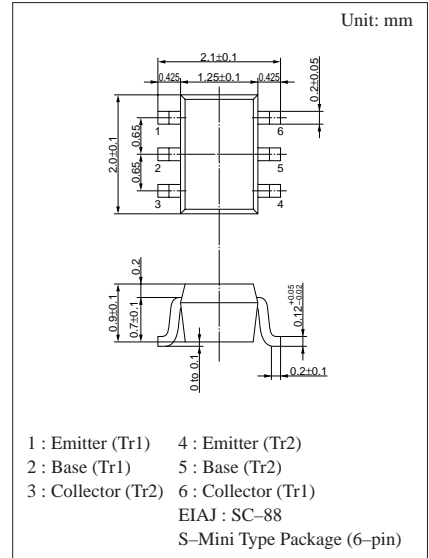

Marking Symbol: ED

Internal Connection

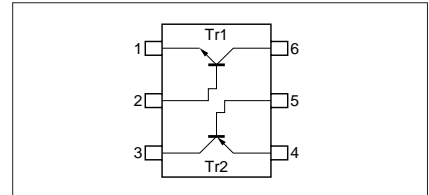

■ Electrical Characteristics (Ta=25°C)

● Tr1

Parameter	Symbol	Conditions	min	typ	max	Unit
Collector cutoff current	I_{CBO}	$V_{CB} = 40V, I_E = 0$			0.1	μA
Emitter cutoff current	I_{EBO}	$V_{EB} = 4V, I_C = 0$			0.1	μA
Forward current transfer ratio	h_{FE}	$V_{CE} = 1V, I_C = 10mA$	60		320	
Collector to emitter saturation voltage	$V_{CE(sat)}$	$I_C = 10mA, I_B = 1mA$		0.17	0.25	V
Base to emitter saturation voltage	$V_{BE(sat)}$	$I_C = 10mA, I_B = 1mA$			1.0	V
Transition frequency	f_T	$V_{CB} = 10V, I_E = -10mA, f = 200MHz$		450		MHz
Collector output capacitance	C_{ob}	$V_{CB} = 10V, I_E = 0, f = 1MHz$		2	6	pF
Turn-on time	t_{on}	*1		17		ns
Turn-off time	t_{off}			17		ns
Storage time	t_{stg}			10		ns

● Tr2

Parameter	Symbol	Conditions	min	typ	max	Unit
Collector cutoff current	I_{CBO}	$V_{CB} = -8V, I_E = 0$			-0.1	μA
Emitter cutoff current	I_{EBO}	$V_{EB} = -3V, I_C = 0$			-0.1	μA
Forward current transfer ratio	h_{FE1}	$V_{CE} = -1V, I_C = -10mA$	50		150	
	h_{FE2}	$V_{CE} = -1V, I_C = -1mA$	30			
Collector to emitter saturation voltage	$V_{CE(sat)}$	$I_C = -10mA, I_B = -1mA$		-0.1	-0.2	V
Transition frequency	f_T	$V_{CB} = -10V, I_E = 10mA, f = 200MHz$	800	1500		MHz
Collector output capacitance	C_{ob}	$V_{CB} = -5V, I_E = 0, f = 1MHz$		1		pF
Turn-on time	t_{on}	*2		12		ns
Turn-off time	t_{off}				20	ns
Storage time	t_{stg}				19	ns

*1 Refer to the test circuit (page 459)

*2 Refer to the test circuit (page 460)

Common characteristics chart

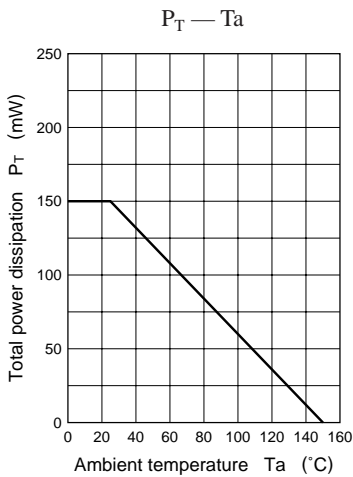

Characteristics charts of Tr1

Switching time measuring circuit

t_{on} , t_{off} Test Circuit

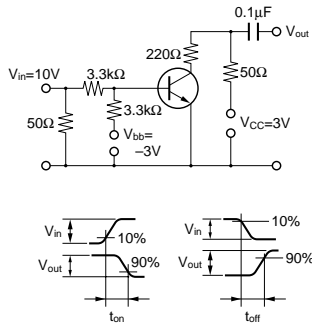

t_{stg} Test Circuit

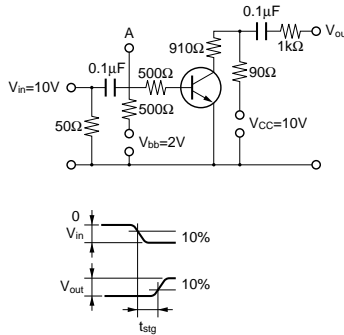

(Wave form at A)

$I_C - V_{CE}$

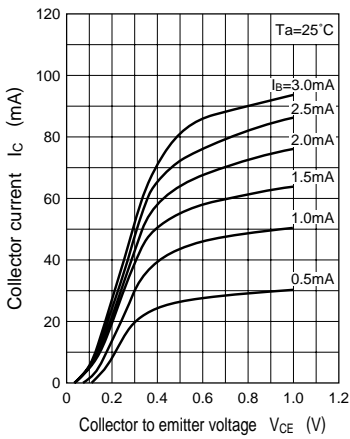

$V_{CE(sat)} - I_C$

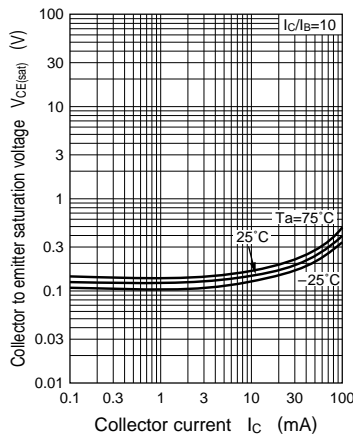

$V_{BE(sat)} - I_C$

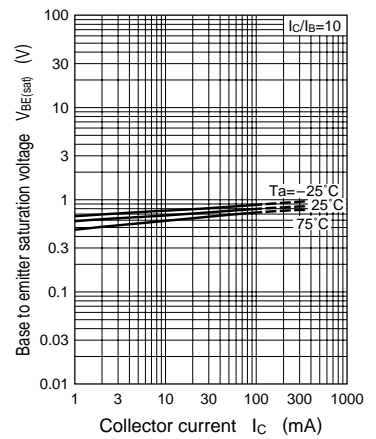

$h_{FE} - I_C$

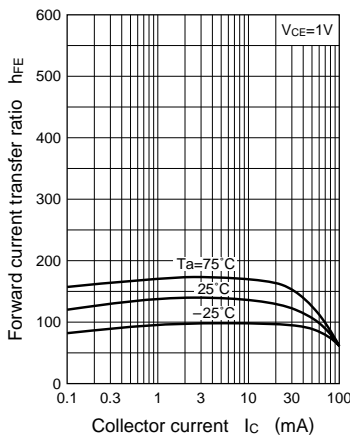

$f_T - I_E$

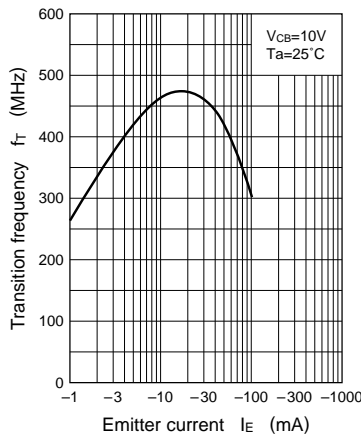

$C_{ob} - V_{CB}$

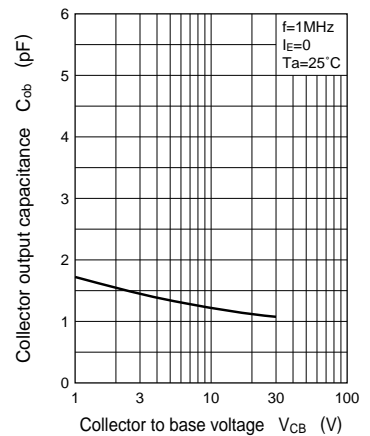

Characteristics charts of Tr2

Switching time measuring circuit

t_{on} , t_{off} Test Circuit

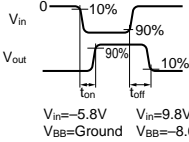
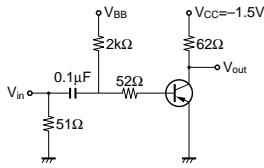

t_{stg} Test Circuit

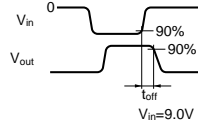
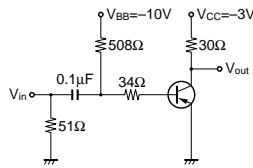

$I_C - V_{CE}$

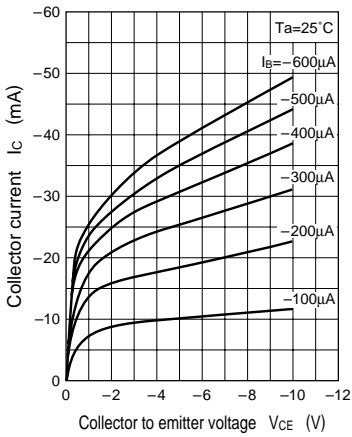

$V_{CE(sat)} - I_C$

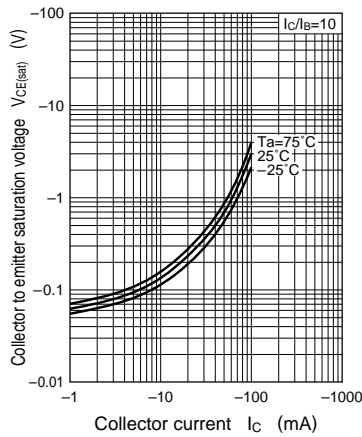

$V_{BE(sat)} - I_C$

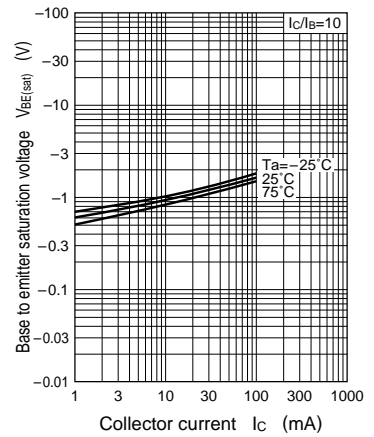

$h_{FE} - I_C$

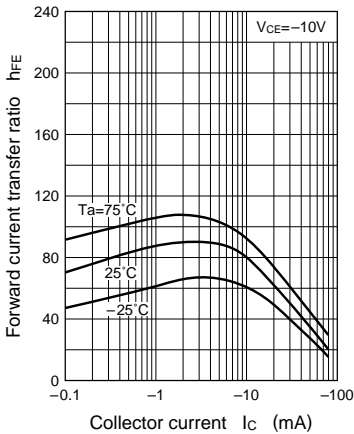

$f_T - I_E$

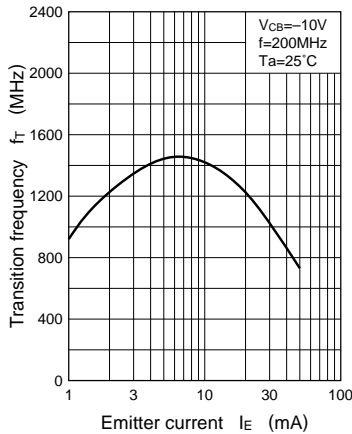

$C_{ob} - V_{CB}$

