

INDICATOR TUBE

Cold cathode gas-filled biquinary numerical indicator tube for side viewing.

QUICK REFERENCE DATA		
Numerical height		15.5 mm
Numerals		0 1 2 3 4 5 6 7 8 9
Supply voltage	V_{ba}	> 170 V
Anode current	I_a	4 mA
Cathode selecting voltage	V_{kk}	50 V
Extinction voltage	V_{ext}	110 V
Screen supply voltage	V_{bs}	50 V
"Off" anode supply voltage	V_{ba} "off"	100 V

GENERAL

The numerals are 15.5 mm high and appear on the same base line allowing in-line read-out. The ZM1030 is provided with a red contrast filter.

PRINCIPLE OF OPERATION

A transparent screen divides the tube into two sections:

- The front section, containing the front- or "odd" anode and the cathode numerals 1-3-5-7-9.
- The rear section, containing the rear- or "even" anode and the cathode numerals 0-2-4-6-8.

The cathodes are internally connected in pairs: 0-1, 2-3, 4-5, 6-7, 8-9.

By applying a suitable voltage between a cathode pair and the "odd" anode the "odd" cathode of that pair will be covered by a red neon glow.

Switching from one number of a pair to the other of that pair is accomplished by decreasing the voltage on the operating anode and simultaneously increasing the voltage on the other anode. ¹⁾

¹⁾ When mechanical or low speed switching is used, a "make before break" arrangement is preferred. During switching the shield connection and the shield supply should be maintained.

DIMENSIONS AND CONNECTIONS

Dimensions in mm

Base: Noval

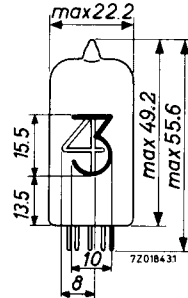
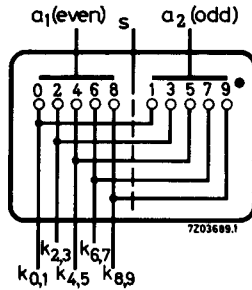
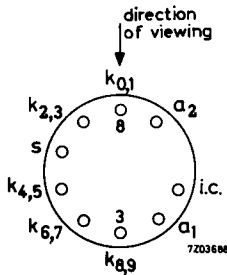

Mounting position

When mounted with the base down the viewing direction will coincide with the line from pin 8 through pin 3 ($\pm 5^\circ$).

CHARACTERISTICS, RANGE VALUES AND OPERATING CONDITIONS

Reference point for all electrode voltages is the "on" cathode.
During operation no electrode should be left floating. See fig.1

Ignition voltage	V_{ign}	< 170 V
Maintaining voltage	V_m	See page 5 and 6
Anode current for coverage, average during any conduction period	I_a	> 3 mA
Anode current, average, $T_{av} = 20$ ms	I_a	< 5 mA
peak, 50 to 60 pps	I_{ap}	< 12 mA
Cathode selecting voltage ¹⁾	V_{kk}	> 40 V ²⁾ < 110 V
"Off" anode supply voltage	V_{ba} "off"	> 85 V < 115 V
Screen voltage	V_s	See page 8
Extinction voltage	V_{ext}	> 110 V

1) The cathode selecting voltage is the voltage difference V_{kk} used for discrimination between the "off" cathodes and the "on" cathode.

2) At low values of V_{kk} , the contrast of the display will be reduced due to glow on adjacent numerals. This will not affect the life of the tube.

Operating conditions

D.C. operation	V_{ba}	200	220	250	300	V
	R_a	15	20	27	39	$k\Omega$
A.C. operation half wave rectified 50 to 60 c/s	V_{ba}	170	220	250	300	V
	R_a	10	18	24	33	$k\Omega$
full wave rectified 100 to 120 c/s	V_{ba}	170	220	250	300	V
	R_a	15	27	33	47	$k\Omega$

LIFE EXPECTANCY at $I_a = 4$ mA

Sequentially changing the display from one digit to another every 500 hours or less

50 000 hours

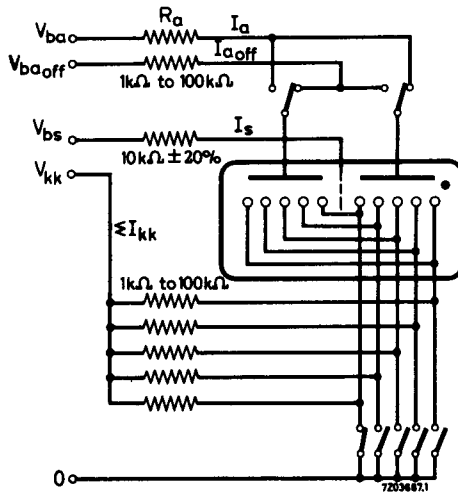

Fig.1

LIMITING VALUES (Absolute max. rating system) See fig. 1

Anode voltage necessary for ignition	V_a	min. 170 V ⁴⁾
Anode current,		
average during any conduction period	I_a	min. 3 mA
average $T_{av} = \text{max. } 20 \text{ ms}$	I_a	max. 5 mA
peak	I_{ap}	max. 12 mA
Cathode selecting voltage ¹⁾	V_{kk}	min. 40 V ²⁾ max. 110 V
"Off" anode supply voltage	V_{ba} "off"	min. 85 V max. 115 V
Screen voltage	V_s	min. 40 V max. 80 V
Bulb temperature,		
storage	t_{bulb}	max. +70 °C min. -55 °C
operation	t_{bulb}	max. +70 °C min. +15 °C ³⁾

REMARK $I_a = I_k + I_{kk} + I_s$

-
- 1) The cathode selecting voltage is the voltage difference V_{kk} used for discrimination between the "off" cathodes and the "on" cathode.
 - 2) At low values of V_{kk} , the contrast of the display will be reduced due to glow on adjacent numerals. This will not affect the life of the tube.
 - 3) Bulb temperatures below 15 °C result in a reduced life expectancy, larger spread and changes in characteristics. See also note ⁴⁾.
 - 4) The minimum supply voltage should be as stated. However the use of the highest voltage available with the appropriate series resistor to maintain the anode current within the specified limit is recommended. The use of "constant current operation" (high supply voltage with high resistor) is recommended when designing equipment operation over a wide temperature range.

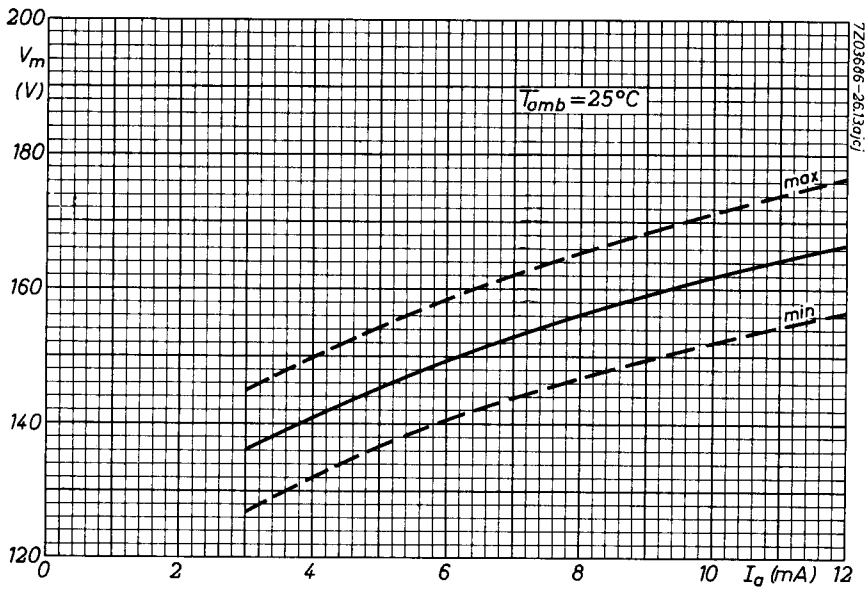

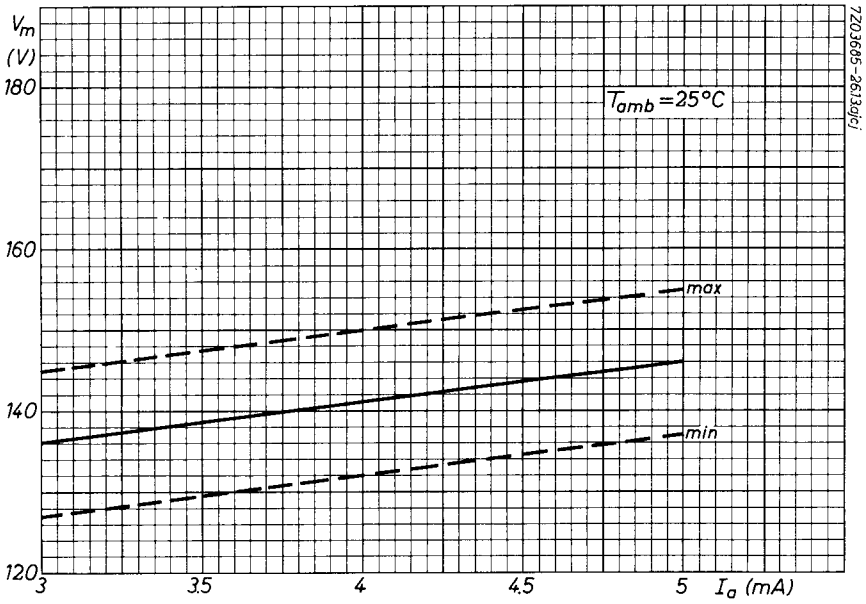

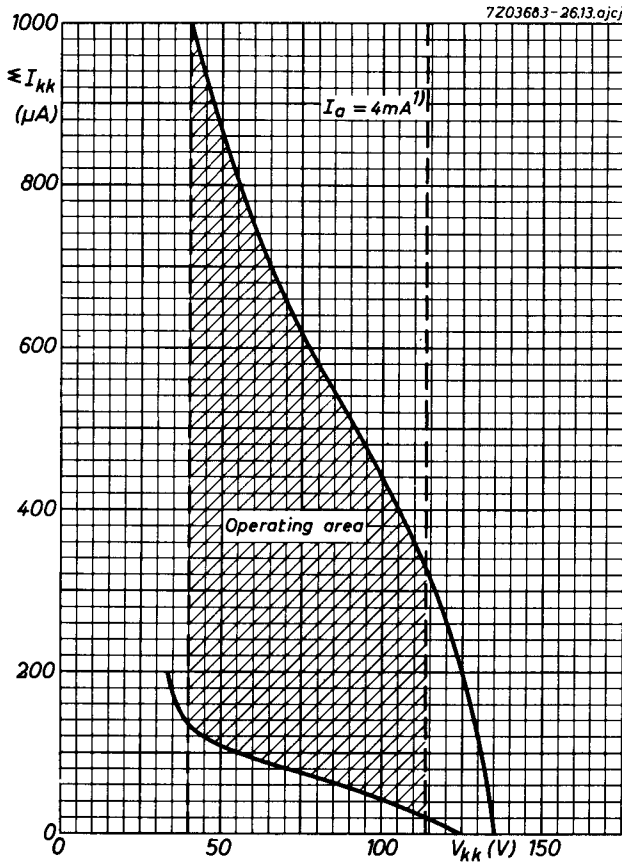

The max. value of I_{kk} to any one pair of numbers will be 55% of I_{kk} .

¹⁾ The values of I_{kk} varies with anode current. Each mA increase or decrease of I_a results in max. 40% increase or decrease respectively of I_{kk} .

7203684-26.13.ajc

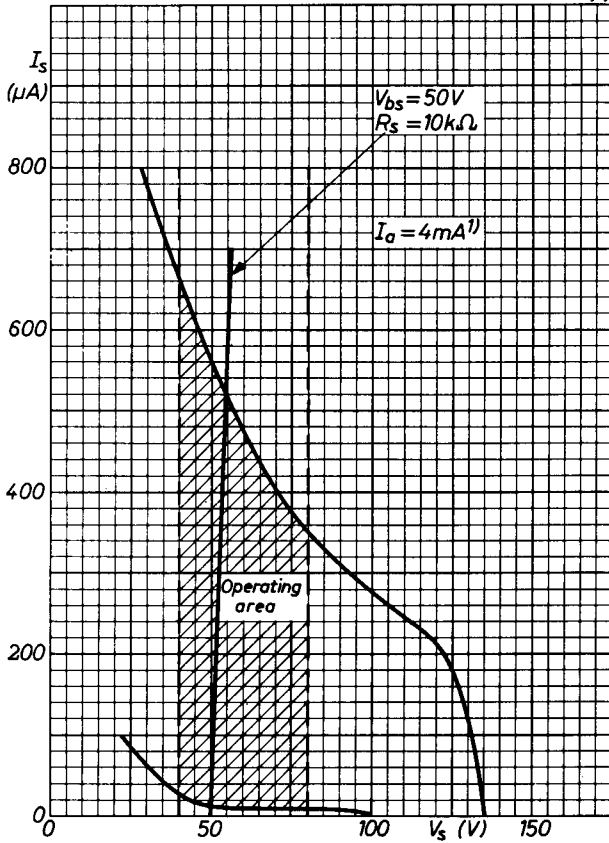

¹⁾ The value of I_S varies with anode current. Each mA increase or decrease of I_a results in max. 30% increase or decrease respectively of I_S .