

# ZXMP2120E5

---

## 200V P-CHANNEL ENHANCEMENT MODE MOSFET

---

### SUMMARY

$V_{(BR)DSS} = -200V$ ;  $R_{DS(ON)} = 28\Omega$ ;  $I_D = -122mA$

### DESCRIPTION

This 200V enhancement mode P-channel MOSFET provides users with a competitive specification offering efficient power handling capability, high impedance and is free from thermal runaway and thermally induced secondary breakdown. Applications benefiting from this device include a variety of Telecom and general high voltage circuits.

A 4 pin SOT223 version is also available (ZXMP2120G4).

### FEATURES

- High voltage
- Low on-resistance
- Fast switching speed
- Low gate drive
- Low threshold
- SOT23-5 package variant engineered to increase spacing between high voltage pins.

### APPLICATIONS

- Active clamping of primary side MOSFETs in 48 volt DC-DC converters

### ORDERING INFORMATION

DEVICE	REEL SIZE (inches)	TAPE WIDTH (mm)	QUANTITY PER REEL
ZXMP2120E5TA	7	8mm embossed	3,000 units

### DEVICE MARKING

- P120

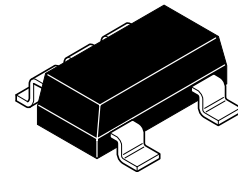

SOT23-5

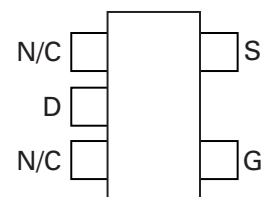
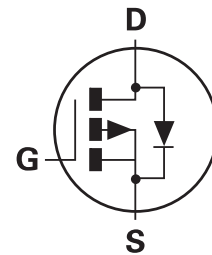

PINOUT - TOP VIEW

# ZXMP2120E5

## ABSOLUTE MAXIMUM RATINGS

PARAMETER	SYMBOL	LIMIT	UNIT
Drain-Source Voltage	$V_{DSS}$	-200	V
Gate Source Voltage	$V_{GS}$	$\pm 20$	V
Continuous Drain Current ( $V_{GS}=10V$ ; $T_{amb}=25^{\circ}C$ ) <sup>(a)</sup>	$I_D$	-122	mA
Pulsed Drain Current (c)	$I_{DM}$	-0.7	A
Pulsed Source Current (Body Diode) <sup>(c)</sup>	$I_{SM}$	-0.7	A
Power Dissipation at $T_{amb}=25^{\circ}C$ <sup>(a)</sup>	$P_D$	0.75	W
Linear Derating Factor		6	mW/ $^{\circ}C$
Operating and Storage Temperature Range	$T_j; T_{stg}$	-55 to +150	$^{\circ}C$

## THERMAL RESISTANCE

PARAMETER	SYMBOL	VALUE	UNIT
Junction to Ambient <sup>(a)</sup>	$R_{\theta JA}$	167	$^{\circ}C/W$

### NOTES

(a) For a device surface mounted on 25mm x 25mm FR4 PCB with high coverage of single sided 1oz copper, in still air conditions

(b) For a device surface mounted on FR4 PCB measured at  $t \leq 5$  secs.

(c) Repetitive rating - pulse width limited by maximum junction temperature. Refer to Transient Thermal Impedance graph.

# ZXMP2120E5

## ELECTRICAL CHARACTERISTICS (at $T_{amb} = 25^{\circ}\text{C}$ unless otherwise stated)

PARAMETER	SYMBOL	MIN.	TYP.	MAX.	UNIT	CONDITIONS.
<b>STATIC</b>						
Drain-Source Breakdown Voltage	$V_{(BR)DSS}$	-200			V	$I_D = -1\text{mA}$ , $V_{GS} = 0\text{V}$
Gate-Source Threshold Voltage	$V_{GS(th)}$	-1.5		-3.5	V	$I_D = -1\text{mA}$ , $V_{DS} = V_{GS}$
Gate-Body Leakage	$I_{GSS}$			20	nA	$V_{GS} = \pm 20\text{V}$ , $V_{DS} = 0\text{V}$
Zero Gate Voltage Drain Current	$I_{DSS}$			-10 -100	$\mu\text{A}$ $\mu\text{A}$	$V_{DS} = -200\text{V}$ , $V_{GS} = 0$ $V_{DS} = -160\text{V}$ , $V_{GS} = 0\text{V}$ , $T = 125^{\circ}\text{C}$ (2)
On-State Drain Current <sup>(1)</sup>	$I_{D(on)}$	-300			mA	$V_{DS} = -25\text{V}$ , $V_{GS} = -10\text{V}$
Static Drain-Source On-State Resistance <sup>(1)</sup>	$R_{DS(on)}$			28	$\Omega$	$V_{GS} = -10\text{V}$ , $I_D = -150\text{mA}$
Forward Transconductance <sup>(1)(2)</sup>	$g_{fs}$	50			mS	$V_{DS} = -25\text{V}$ , $I_D = -150\text{mA}$
<b>DYNAMIC</b>						
Input Capacitance <sup>(2)</sup>	$C_{iss}$			100	pF	$V_{DS} = -25\text{V}$ , $V_{GS} = 0\text{V}$ , $f = 1\text{MHz}$
Output Capacitance <sup>(2)</sup>	$C_{oss}$			25	pF	
Reverse Transfer Capacitance <sup>(2)</sup>	$C_{rss}$			7	pF	
<b>SWITCHING</b>						
Turn-On Delay Time <sup>(2)(3)</sup>	$t_{d(on)}$			7	ns	$V_{DD} = -25\text{V}$ , $I_D = -150\text{mA}$
Rise Time <sup>(2)(3)</sup>	$t_r$			15	ns	
Turn-Off Delay Time <sup>(2)(3)</sup>	$t_{d(off)}$			12	ns	
Fall Time <sup>(2)(3)</sup>	$t_f$			15	ns	

### NOTES:

(1) Measured under pulsed conditions. Width=300 $\mu\text{s}$ . Duty cycle  $\leq 2\%$ .

(2) Sample test.

(3) Switching times measured with 50 $\Omega$  source impedance and <5ns rise time on a pulse generator.

# ZXMP2120E5

## TYPICAL CHARACTERISTICS

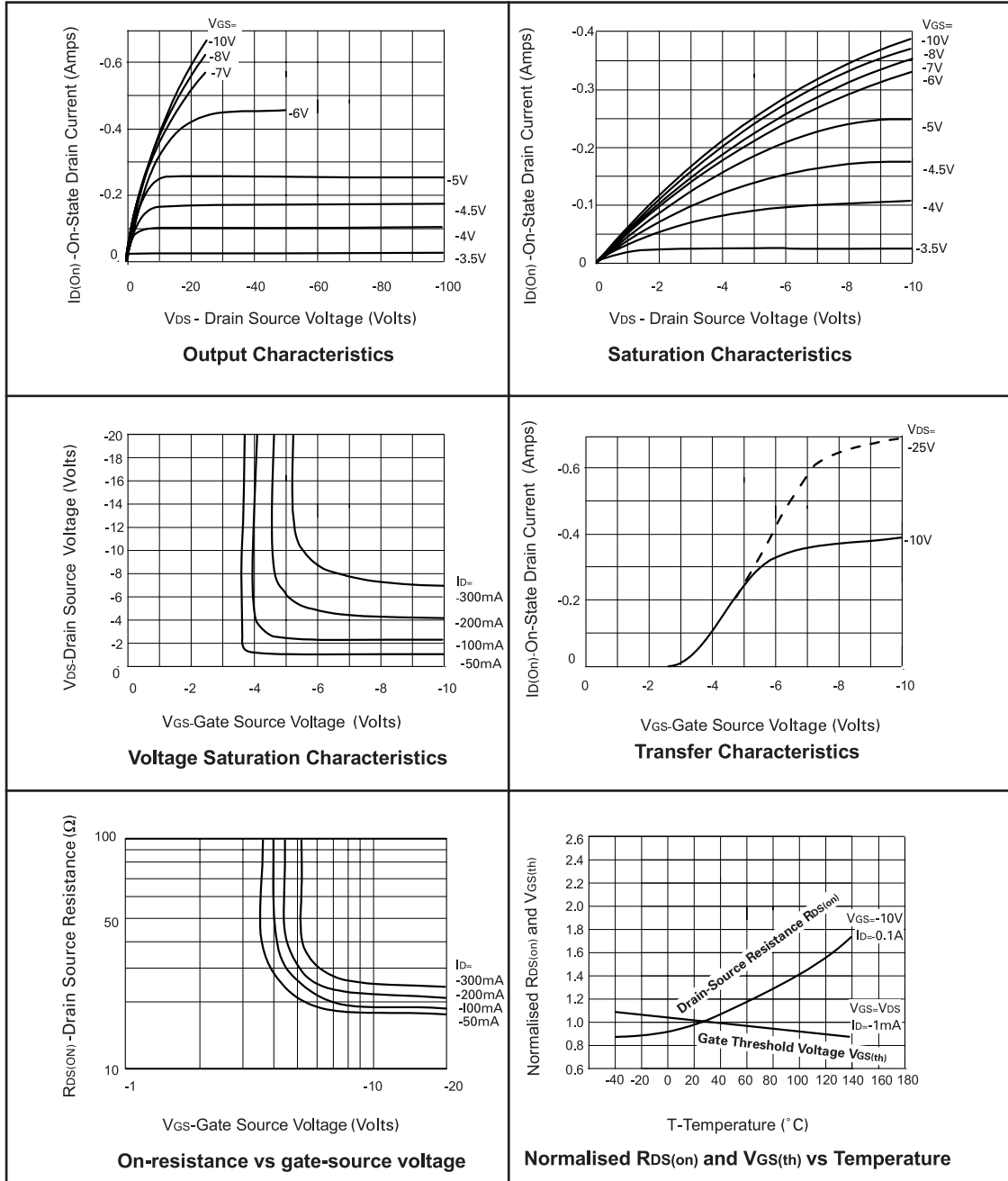

# ZXMP2120E5

## CHARACTERISTICS

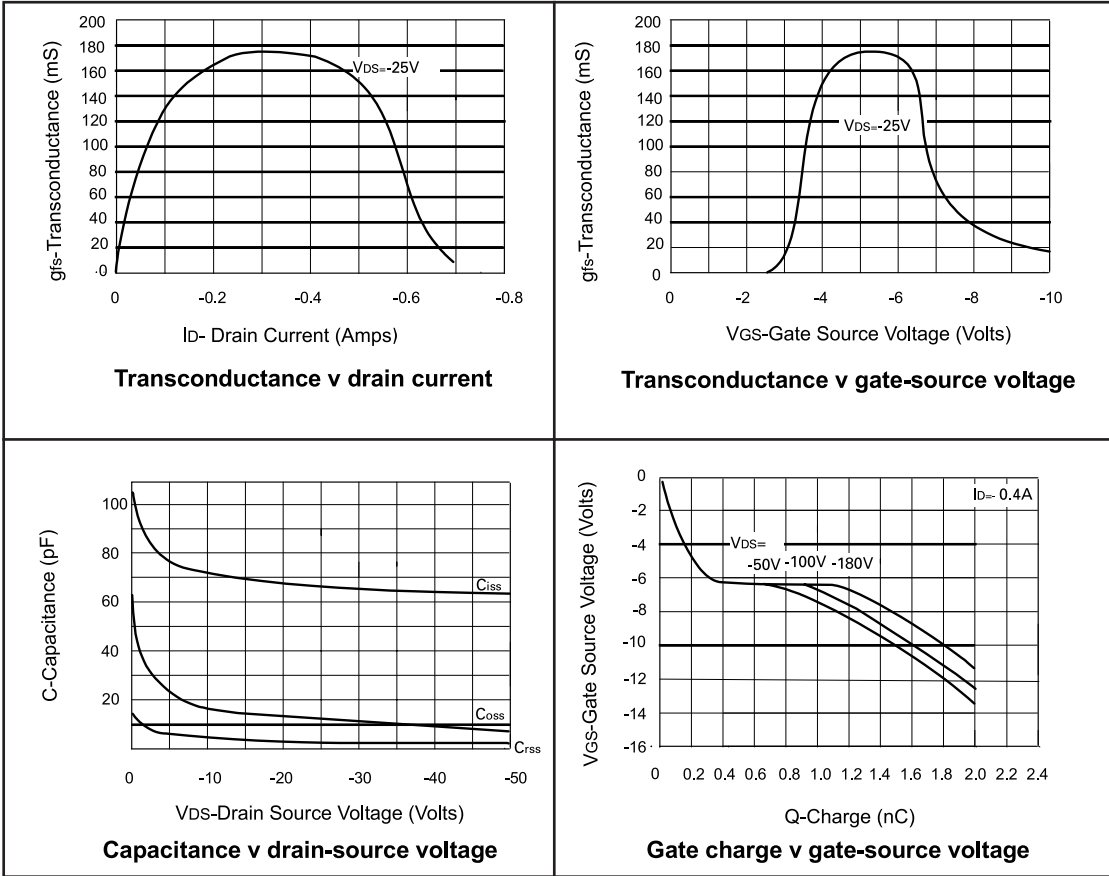

# ZXMP2120E5

## PACKAGE OUTLINE

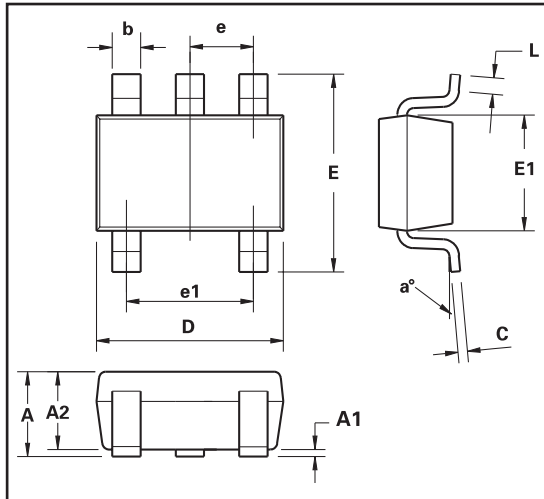

## PAD LAYOUT DETAILS

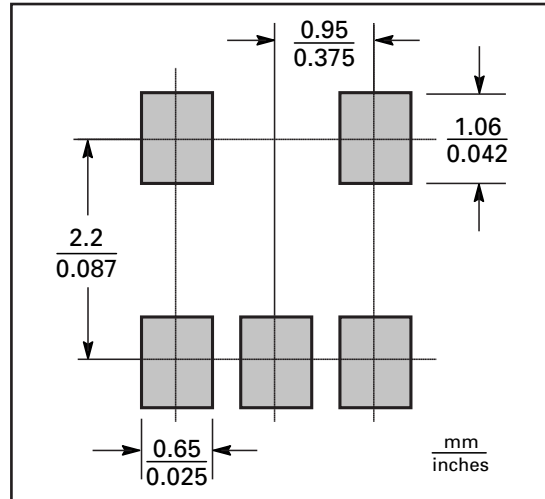

Controlling dimensions are in millimeters. Approximate conversions are given in inches

## PACKAGE DIMENSIONS

DIM	Millimeters		Inches	
	MIN.	MAX.	MIN.	MAX.
A	0.90	1.45	0.0354	0.0570
A1	-	0.15	-	0.0059
A2	0.90	1.30	0.0354	0.0511
b	0.20	0.50	0.0078	0.0196
C	0.09	0.26	0.0035	0.0102
D	2.70	3.10	0.1062	0.1220

DIM	Millimeters		Inches	
	MIN.	MAX.	MIN.	MAX.
E	2.20	3.20	0.0866	0.1181
E1	1.30	1.80	0.0511	0.0708
e	0.95 REF		0.0374 REF	
e1	1.90 REF		0.0748 REF	
L	0.10	0.60	0.0039	0.0236
a	0°	30°	0°	30°

© Zetex Semiconductors plc 2006

Europe	Americas	Asia Pacific	Corporate Headquarters
Zetex GmbH Kustermann-park Balanstraße 59 D-81541 München Germany Telefon: (49) 89 45 49 49 0 Fax: (49) 89 45 49 49 49 <a href="mailto:europe.sales@zetex.com">europe.sales@zetex.com</a>	Zetex Inc 700 Veterans Memorial Hwy Hauppauge, NY 11788 USA Telephone: (1) 631 360 2222 Fax: (1) 631 360 8222 <a href="mailto:usa.sales@zetex.com">usa.sales@zetex.com</a>	Zetex (Asia) Ltd 3701-04 Metroplaza Tower 1 Hing Fong Road, Kwai Fong Hong Kong Telephone: (852) 26100 611 Fax: (852) 24250 494 <a href="mailto:asia.sales@zetex.com">asia.sales@zetex.com</a>	Zetex Semiconductors plc Zetex Technology Park Chadderton, Oldham, OL9 9LL United Kingdom Telephone (44) 161 622 4444 Fax: (44) 161 622 4446 <a href="mailto:hq@zetex.com">hq@zetex.com</a>

These offices are supported by agents and distributors in major countries world-wide.

This publication is issued to provide outline information only which (unless agreed by the Company in writing) may not be used, applied or reproduced for any purpose or form part of any order or contract or be regarded as a representation relating to the products or services concerned. The Company reserves the right to alter without notice the specification, design, price or conditions of supply of any product or service.

For the latest product information, log on to [www.zetex.com](http://www.zetex.com)



ISSUE 2 - SEPTEMBER 2006