

6N138, 6N139 OPTOCOUPLEDERS/OPTOISOLATORS

SOOS005 D3012, JULY 1986

- Compatible with TTL Inputs
- High Current Transfer Ratio . . . 800% Typ at $I_f = 0.5 \text{ mA}$
- High-Speed Switching . . . 100 kbit/s Typ
- High Common-Mode Transient Immunity . . . 500 $\text{V}/\mu\text{s}$ Typ
- High-Voltage Electrical Insulation . . . 3000 V DC Min
- High Output Current Rating of 60 mA
- UL Recognized . . . File Number 65085

description

These devices are useful where large common-mode input signals exist, and in applications that require high-voltage isolation between circuits. Applications include line receivers, telephone ring detectors, power line monitors, high-voltage status indicators, and circuits that require isolation between input and output.

The 6N138 and 6N139 high-gain optocouplers each consists of a GaAsP light-emitting diode and an integrated high-gain photon detector composed of a photodiode and a split-Darlington output stage. The VCC and output terminals may be tied together to achieve conventional photodarlington operation. A separate base access terminal allows gain-bandwidth adjustments.

The 6N138 is designed for use primarily in TTL applications. An LED input current of 1.6 milliamperes and a current-transfer ratio of 300% from 0°C to 70°C allows operation with one TTL load input and one TTL load output utilizing a 2.2-k Ω pullup resistor.

The 6N139 is designed for use in CMOS, LSTTL, or other low-power applications. This device has a minimum current-transfer ratio of 400% for only 0.5 milliamperes input current over an operating temperature range of 0°C to 70°C.

*mechanical data

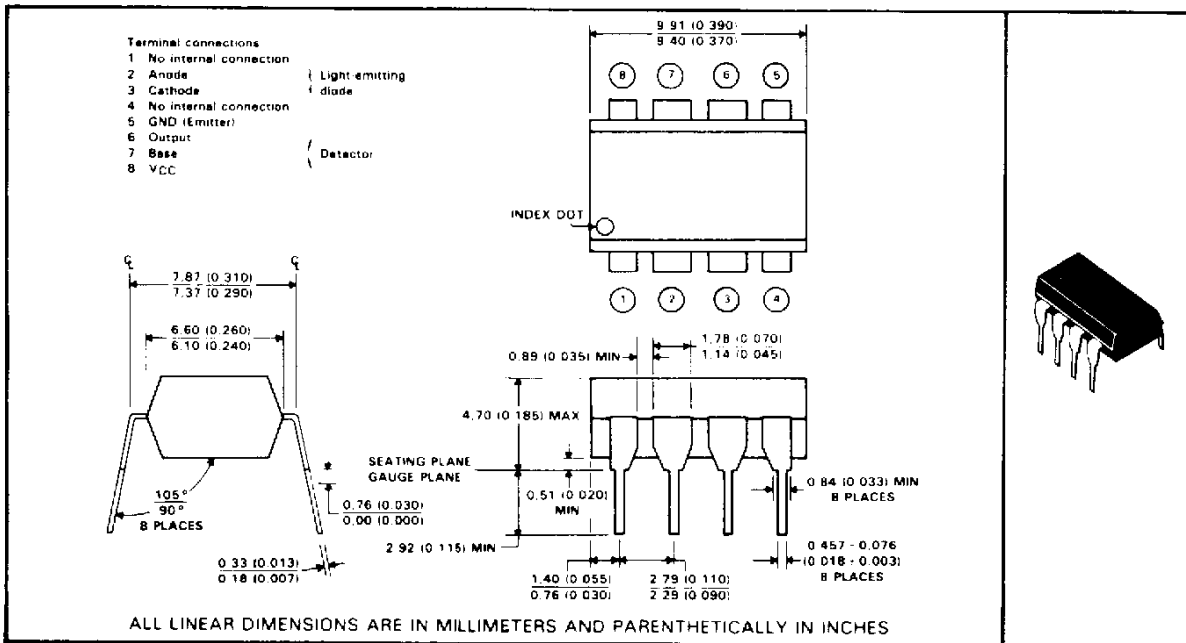

*JEDEC registered data. This data sheet contains all applicable registered data in effect at the time of publication.

PRODUCTION DATA documents contain information current as of publication date. Products conform to specifications per the terms of Texas Instruments standard warranty. Production processing does not necessarily include testing of all parameters.

TEXAS
INSTRUMENTS

POST OFFICE BOX 655303 - DALLAS, TEXAS 75285

Copyright © 1986, Texas Instruments Incorporated

**6N138, 6N139
OPTOCOUPLEDERS/OPTOISOLATORS**

schematic

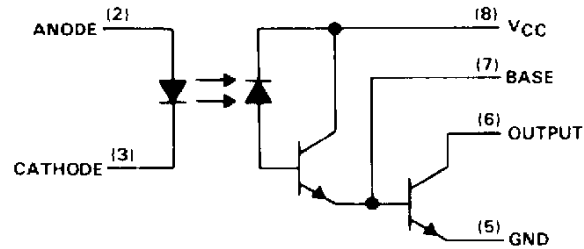

***absolute maximum ratings at 25 °C free-air temperature (unless otherwise noted)**

Supply and output voltage range, V_{CC} and V_O : 6N138	-0.5 V to 7 V
6N139	-0.5 to 18 V
Reverse input voltage	5 V
Emitter-base reverse voltage	0.5 V
Peak input forward current (pulse duration = 1 ms, 50% duty cycle)	40 mA
Peak transient input forward current (pulse duration $\leq 1 \mu s$, 300 pps)	1 A
Average forward input current at (or below) 50 °C free-air temperature (see Note 1)	20 mA
Output current at (or below) 25 °C free-air temperature (see Note 2)	60 mA
Input power dissipation at (or below) 50 °C free-air temperature (see Note 3)	35 mW
Output power dissipation at (or below) 25 °C free-air temperature (see Note 4)	100 mW
Storage temperature range	-55 °C to 125 °C
Operating temperature range	0 °C to 100 °C
Lead temperature 1,6 mm (1/16 inch) from case for 10 seconds	260 °C

- NOTES
1. Derate linearly above 50 °C free-air temperature at a rate of 0.4 mA/°C.
 2. Derate linearly above 25 °C free air temperature at a rate of 0.8 mA/°C.
 3. Derate linearly above 50 °C free air temperature at a rate of 0.7 mW/°C.
 4. Derate linearly above 25 °C free-air temperature at a rate of 1.33 mW/°C.

*JEDEC registered data.

6N138, 6N139 OPTOCOUPERS/OPTOISOLATORS

electrical characteristics over operating free-air temperature range of 0°C to 70°C (unless otherwise noted)

PARAMETER	TEST CONDITIONS	6N138			6N139			UNIT
		MIN	TYP†	MAX	MIN	TYP†	MAX	
*V _F Input forward voltage	I _F = 1.6 mA, T _A = 25°C		1.5	1.7		1.5	1.7	V
αV _F Temperature coefficient of forward voltage	I _F = 1.6 mA		-1.8			-1.8		mV/°C
*V _{BR} Input breakdown voltage	I _R = 10 μA, T _A = 25°C		5			5		V
V _{OL} Low-level output voltage	V _{CC} = 4.5 V, I _F = 1.6 mA, I _{OL} = 4.8 mA, I _B = 0		0.1	0.4				V
	V _{CC} = 4.5 V, I _F = 1.6 mA, I _{OL} = 6.4 mA, I _B = 0					0.1	0.4	
	V _{CC} = 4.5 V, I _F = 5 mA, I _{OL} = 15 mA, I _B = 0					0.1	0.4	
	V _{CC} = 4.5 V, I _F = 12 mA, I _{OL} = 24 mA, I _B = 0					0.2	0.4	
*I _{OH} High-level output current	V _{CC} = 7 V, V _O = 7 V, I _F = 0, I _B = 0		0.1	250				μA
	V _{CC} = 18 V, V _O = 18 V, I _F = 0, I _B = 0					0.05	100	
*I _{CHH} Supply current, high-level output	V _{CC} = 5 V, V _O open, I _F = 0, I _B = 0		10			10		nA
I _{CLL} Supply current, low-level output	V _{CC} = 5 V, V _O open, I _F = 1.6 mA, I _B = 0		0.2			0.2		mA
*CTR Current transfer ratio	V _{CC} = 4.5 V, V _O = 0.4 V, I _F = 0.5 mA, I _B = 0, See Note 5					400%	1650%	
	V _{CC} = 4.5 V, V _O = 0.4 V, I _F = 1.6 mA, I _B = 0, See Note 5		300%	1300%		500%	1400%	
r _{IO} Input-output resistance	V _{IO} = 500 V, See Note 6		10 ¹²			10 ¹²		Ω
*I _{IO} Input-output insulation leakage current	V _{IO} = 3000 V, t = 5 s, T _A = 25°C, RH = 45%, See Note 6			1			1	μA
C _I Input capacitance	V _F = 0, f = 1 MHz		60			60		pF
C _{IO} Input-output capacitance	f = 1 MHz, See Note 6		0.6			0.6		pF

*JEDEC registered data

†All typical values are at V_{CC} = 5 V, T_A = 25°C, unless otherwise noted.

NOTES. 5. Current transfer ratio is defined as the ratio of output collector current I_O to the forward LED input current I_F times 100%.

6. These parameters are measured between pins 2 and 3 shorted together and pins 5, 6, 7, and 8 shorted together.

6N138, 6N139
OPTOCOUPERS/OPTOISOLATORS

*switching characteristics at $V_{CC} = 5\text{ V}$, $T_A = 25^\circ\text{C}$

PARAMETER	TEST CONDITIONS	6N138			6N139			UNIT
		MIN	TYP	MAX	MIN	TYP	MAX	
* t_{PHL} Propagation delay time, high-to-low level output	$I_F = 1.6\text{ mA}$, $R_L = 2.2\text{ k}\Omega$, See Figure 1		2	10				μs
	$I_F = 0.5\text{ mA}$, $R_L = 4.7\text{ k}\Omega$, See Figure 1				4	25		
	$I_F = 12\text{ mA}$, $R_L = 270\ \Omega$, See Figure 1				0.3	1		
* t_{PLH} Propagation delay time, low-to-high-level output	$I_F = 1.6\text{ mA}$, $R_L = 2.2\text{ k}\Omega$, See Figure 1		4	35				μs
	$I_F = 0.5\text{ mA}$, $R_L = 4.7\text{ k}\Omega$, See Figure 1				10	60		
	$I_F = 12\text{ mA}$, $R_L = 270\ \Omega$, See Figure 1				3.5	7		
$\frac{dV_{CM}}{dt}$ (H) Common-mode input transient immunity, high-level output	$V_{CM} = 10\text{ Vp-p}$, $I_F = 0$, $R_L = 2.2\text{ k}\Omega$, See Figure 2		500		500			$\text{V}/\mu\text{s}$
$\frac{dV_{CM}}{dt}$ (LI) Common-mode input transient immunity, low-level output	$V_{CM} = V_{p-p}$, $R_L = 2.2\text{ k}\Omega$, See Figure 2, See Notes 7 and 8		-500		500			$\text{V}/\mu\text{s}$

*JEDEC registered data

NOTES: 7. Common-mode transient immunity, high-level output, is the maximum rate of rise of the common-mode input voltage that does not cause the output voltage to drop below 2 V. Common mode input transient immunity, low level output, is the maximum rate of fall of the common mode input voltage that does not cause the output voltage to rise above 0.8 V.

8. In applications where dV/dt may exceed 50,000 $\text{V}/\mu\text{s}$ (such as static discharge) a series resistor, R_{CC} , should be included to protect the detector IC from destructively high surge currents. The recommended value is:

$$R_{CC} = \frac{1}{0.15 I_F (\text{mA})} \text{ k}\Omega$$

PARAMETER MEASUREMENT INFORMATION

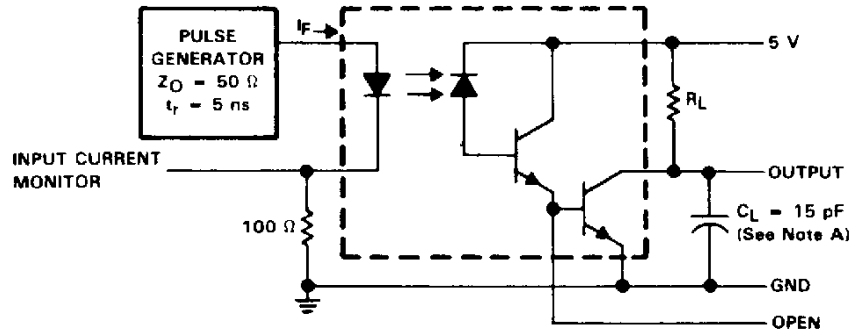

TEST CIRCUIT

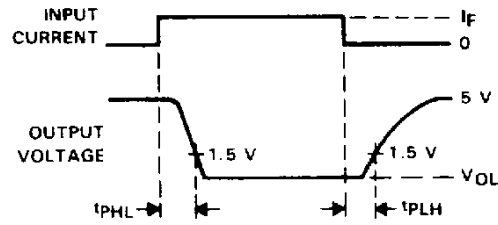

WAVEFORMS

NOTE A C_L includes probe and stray capacitances.

FIGURE 1. SWITCHING TEST CIRCUIT AND WAVEFORMS

**6N138, 6N139
OPTOCOUPLEDERS/OPTOISOLATORS**

PARAMETER MEASUREMENT INFORMATION

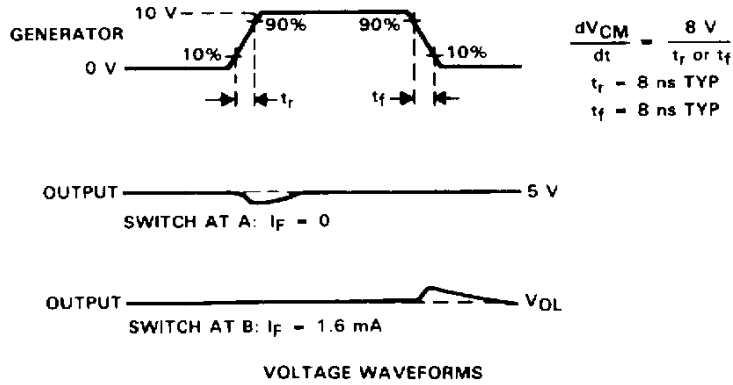
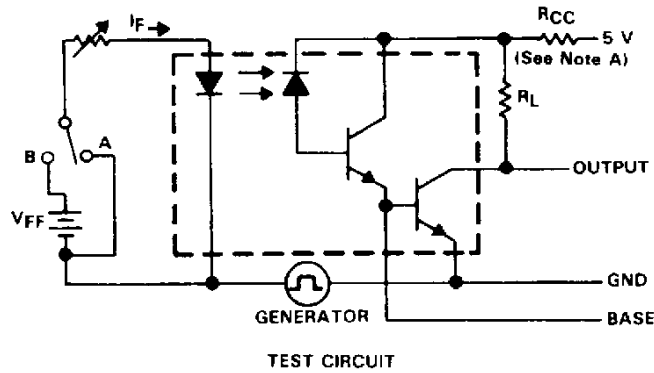

$$\frac{dV_{CM}}{dt} = \frac{8 \text{ V}}{t_r \text{ or } t_f}$$

$t_r = 8 \text{ ns TYP}$
 $t_f = 8 \text{ ns TYP}$

NOTE A: In applications where dV/dt may exceed $50,000 \text{ V}/\mu\text{s}$ (such as static discharge) a series resistor, R_{CC} , should be included to protect the detector IC from destructively high surge currents. The recommended value is:

$$R_{CC} = \frac{1}{0.15 I_F (\text{mA})} \text{ k}\Omega$$

FIGURE 2. TRANSIENT IMMUNITY TEST CIRCUIT AND WAVEFORMS

TYPICAL CHARACTERISTICS

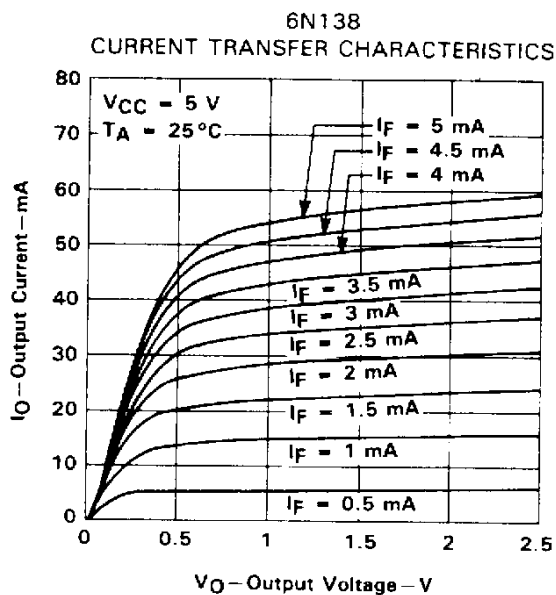

FIGURE 3

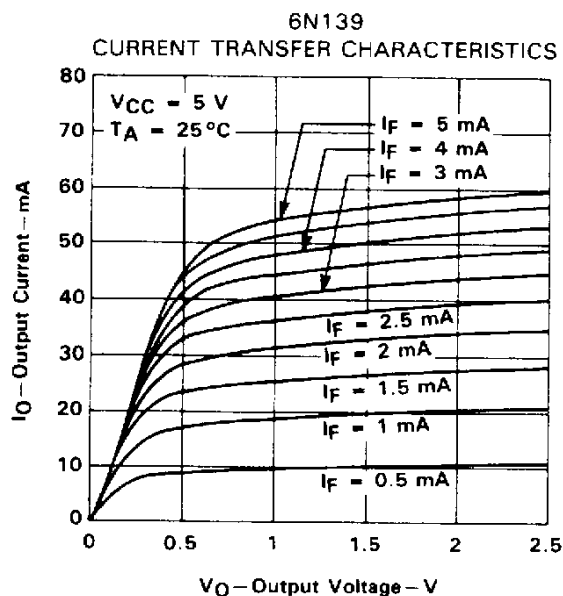

FIGURE 4

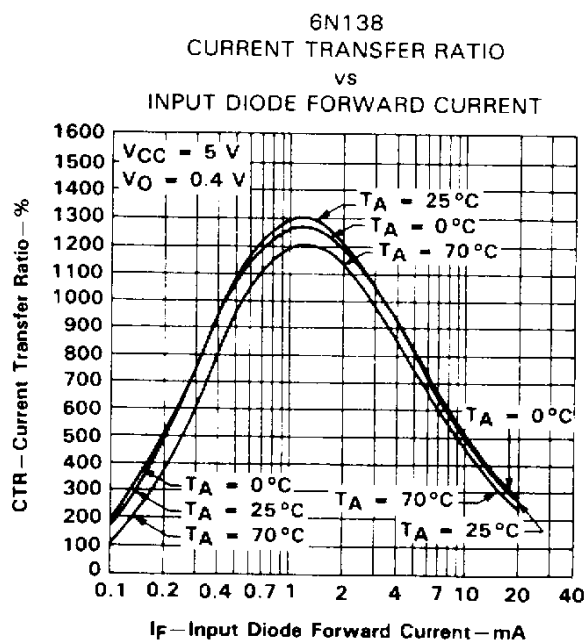

FIGURE 5

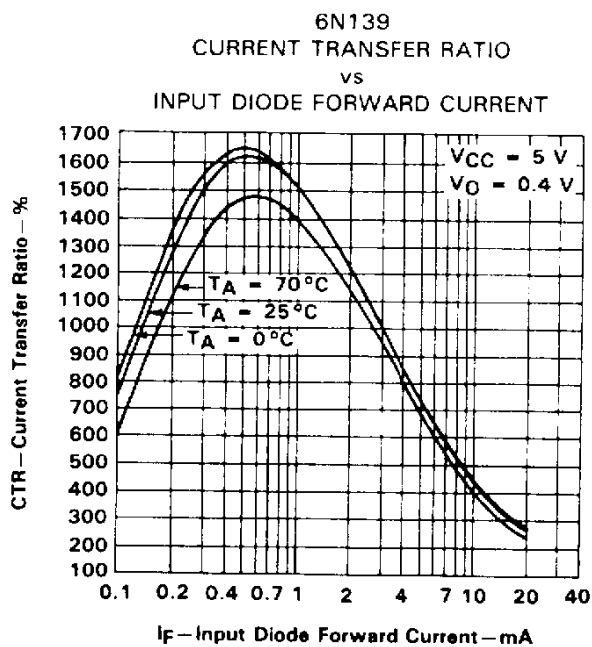
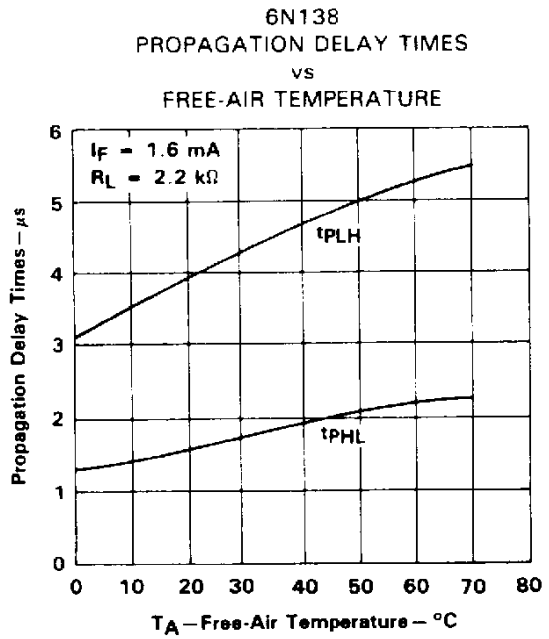
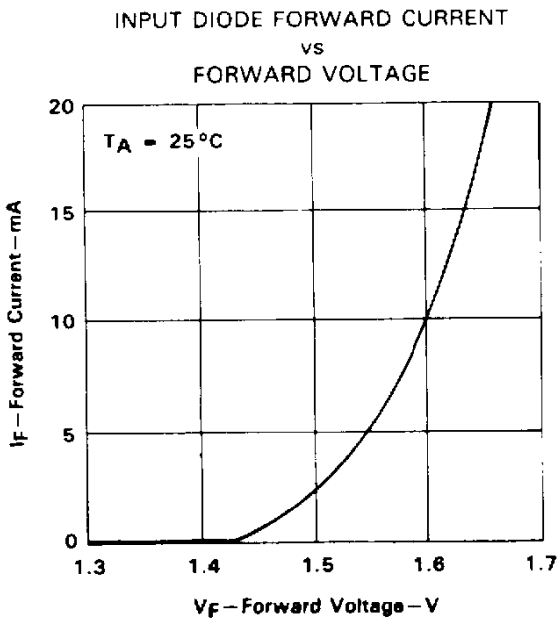
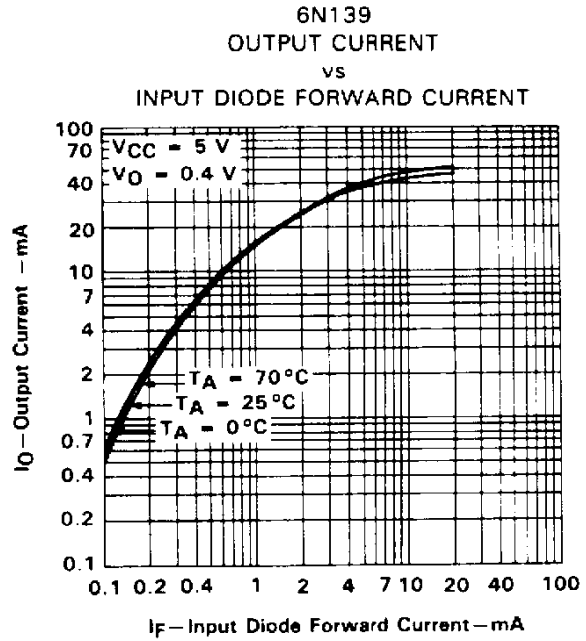
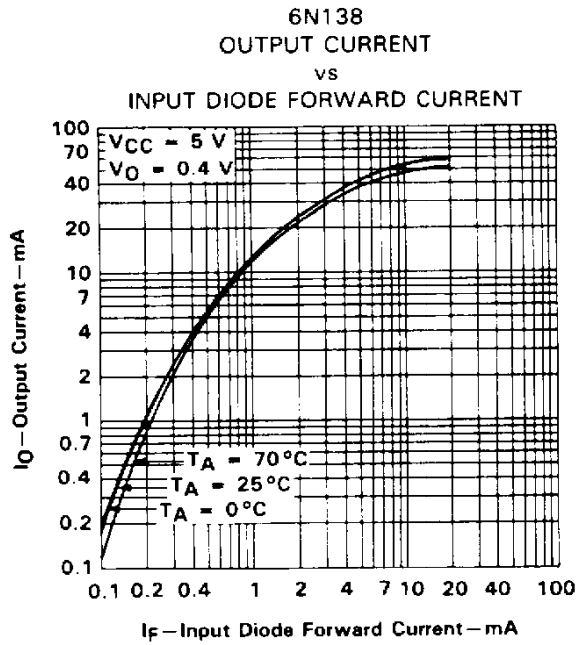

FIGURE 6

6N138, 6N139
OPTOCOUPLEDERS/OPTOISOLATORS

TYPICAL CHARACTERISTICS



TYPICAL CHARACTERISTICS

6N139
PROPAGATION DELAY TIMES
vs
FREE-AIR TEMPERATURE

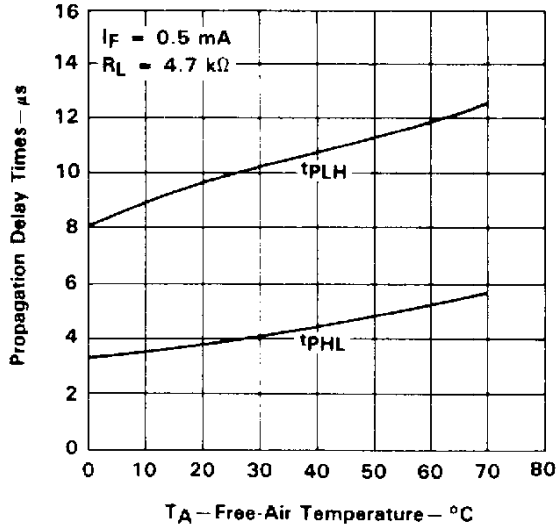

FIGURE 11

6N139
PROPAGATION DELAY TIMES
vs
FREE-AIR TEMPERATURE

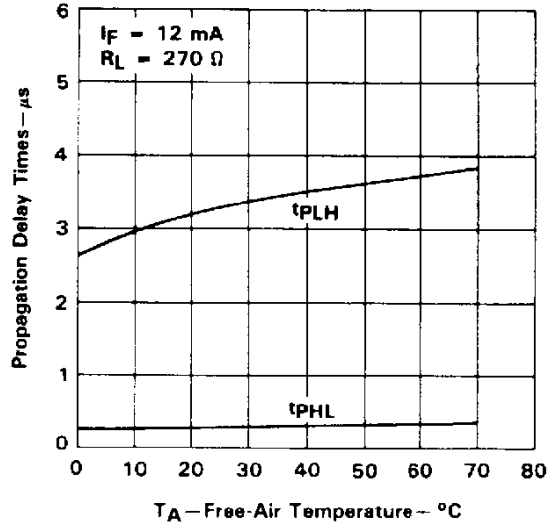

FIGURE 12

IMPORTANT NOTICE

Texas Instruments and its subsidiaries (TI) reserve the right to make changes to their products or to discontinue any product or service without notice, and advise customers to obtain the latest version of relevant information to verify, before placing orders, that information being relied on is current and complete. All products are sold subject to the terms and conditions of sale supplied at the time of order acknowledgement, including those pertaining to warranty, patent infringement, and limitation of liability.

TI warrants performance of its semiconductor products to the specifications applicable at the time of sale in accordance with TI's standard warranty. Testing and other quality control techniques are utilized to the extent TI deems necessary to support this warranty. Specific testing of all parameters of each device is not necessarily performed, except those mandated by government requirements.

CERTAIN APPLICATIONS USING SEMICONDUCTOR PRODUCTS MAY INVOLVE POTENTIAL RISKS OF DEATH, PERSONAL INJURY, OR SEVERE PROPERTY OR ENVIRONMENTAL DAMAGE ("CRITICAL APPLICATIONS"). TI SEMICONDUCTOR PRODUCTS ARE NOT DESIGNED, AUTHORIZED, OR WARRANTED TO BE SUITABLE FOR USE IN LIFE-SUPPORT DEVICES OR SYSTEMS OR OTHER CRITICAL APPLICATIONS. INCLUSION OF TI PRODUCTS IN SUCH APPLICATIONS IS UNDERSTOOD TO BE FULLY AT THE CUSTOMER'S RISK.

In order to minimize risks associated with the customer's applications, adequate design and operating safeguards must be provided by the customer to minimize inherent or procedural hazards.

TI assumes no liability for applications assistance or customer product design. TI does not warrant or represent that any license, either express or implied, is granted under any patent right, copyright, mask work right, or other intellectual property right of TI covering or relating to any combination, machine, or process in which such semiconductor products or services might be or are used. TI's publication of information regarding any third party's products or services does not constitute TI's approval, warranty or endorsement thereof.