



3.5Ω/7Ω、四路 SPST 开关， 可处理超摆幅信号

概述

MAX4851/MAX4851H/MAX4853/MAX4853H 系列是四路单刀/单掷 (SPST) 开关，工作在 +2V 至 +5.5V 单电源，可以处理大于电源摆幅的信号。这些开关具有 3.5Ω 低导通电阻和 40pF 导通电容，或者 7Ω 导通电阻和 30pF 导通电容，可理想用于音频与数据信号的切换。

MAX4851/MAX4851H 配置为四个 SPST 开关，具有一个比较器，用于耳机检测或静音/传送按键功能。MAX4853/MAX4853H 有四个 SPST 开关，但不具备比较器。

对于超摆幅应用，这些器件提供信号通过或高阻两种选择。对于 MAX4851/MAX4853，超过正电源的信号 (高达 5.5V) 仍可以不失真地通过开关。对于 MAX4851H/MAX4853H，当输入信号超出电源摆幅时，开关输入变为高阻状态。

MAX4851/MAX4851H/MAX4853/MAX4853H 提供节省空间的、16 引脚、3mm x 3mm 薄型 QFN 封装，工作在 -40°C 至 +85°C 扩展级温度范围。

应用

USB 开关
音频信号切换
蜂窝电话
笔记本电脑
PDA 及其它手持式设备

特性

- ◆ USB 2.0 全速 (12Mbps) 和 USB 1.1 信号开关
- ◆ 可切换大于 V_{CC} 的信号
- ◆ +2V 至 +5.5V 电源范围
- ◆ 3.5Ω/7Ω 导通电阻
- ◆ 30pF 导通电容 (7Ω 开关)
- ◆ -3dB 带宽: 150MHz
- ◆ 与 1.8V 逻辑兼容
- ◆ 低电源电流
 - 0.01μA (MAX4853)
 - 5μA (MAX4851)
 - 10μA (MAX4851H/MAX4853H)
- ◆ 0.01nA 低漏电流
- ◆ 提供节省空间的 3mm x 3mm、16 引脚 TQFN 封装

订购信息

PART	TEMP RANGE	PIN-PACKAGE	TOP MARK
MAX4851ETE	-40°C to +85°C	16 TQFN-EP*	ABW
MAX4851HETE	-40°C to +85°C	16 TQFN-EP*	ABX
MAX4853ETE	-40°C to +85°C	16 TQFN-EP*	ACB
MAX4853HETE	-40°C to +85°C	16 TQFN-EP*	ACC

* EP = 裸露焊盘。

方框图/真值表

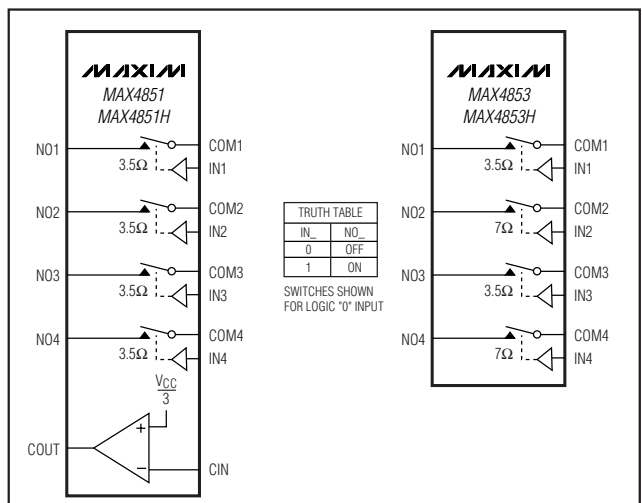

引脚配置和典型工作电路在数据资料的最后部分给出。

3.5Ω/7Ω、四路 SPST 开关， 可处理超摆幅信号

ABSOLUTE MAXIMUM RATINGS

V_{CC}, IN₋, CIN, COM₋, NO₋ to GND (Note 1)-0.3V to +6.0V
 COUT-0.3V to (V_{CC} + 0.3V)
 COUT Continuous Current±20mA
 Closed-Switch Continuous Current COM₋, NO₋, NC₋
 3.5Ω Switch±100mA
 7Ω Switch±50mA
 Peak Current COM₋, NO₋ (pulsed at 1ms, 50% duty cycle)
 3.5Ω Switch±200mA
 7Ω Switch±100mA

Peak Current COM₋, NO₋ (pulsed at 1ms, 10% duty cycle)
 3.5Ω Switch±240mA
 7Ω Switch±120mA
 Continuous Power Dissipation (T_A = +70°C)
 16-Pin Thin QFN (derate 20.8mW/°C above +70°C) ...1667mW
 Operating Temperature Range-40°C to +85°C
 Junction Temperature+150°C
 Storage Temperature Range-65°C to +150°C
 Lead Temperature (soldering, 10s)+300°C

Note 1: Signals on IN₋, NO₋, or COM₋ below GND are clamped by internal diodes. Limit forward-diode current to maximum current rating.

Stresses beyond those listed under "Absolute Maximum Ratings" may cause permanent damage to the device. These are stress ratings only, and functional operation of the device at these or any other conditions beyond those indicated in the operational sections of the specifications is not implied. Exposure to absolute maximum rating conditions for extended periods may affect device reliability.

ELECTRICAL CHARACTERISTICS

(V_{CC} = +2.7V to +5.5V, T_A = -40°C to +85°C, unless otherwise noted. Typical values are at V_{CC} = +3.0V, T_A = +25°C, unless otherwise noted.) (Note 2)

PARAMETER	SYMBOL	CONDITIONS		MIN	TYP	MAX	UNITS
Supply Voltage	V _{CC}			2.0		5.5	V
Supply Current	I _{CC}	V _{CC} = 5.5V, V _{IN₋} = 0 or V _{CC}	MAX4851		5	10	μA
			MAX4851H/MAX4853H		10	20	
			MAX4853		0.01	1	
ANALOG SWITCH (3.5Ω Switch)							
Analog Signal Range	V _{NO₋} , V _{COM₋}			0		5.5	V
On-Resistance	R _{ON}	V _{CC} = 3V, I _{COM₋} = 10mA, V _{NO₋} = 0 to 5.5V (MAX485 ₋) or V _{CC} (MAX485 ₋ H)	T _A = +25°C		3.5	4.5	Ω
			T _A = -40°C to +85°C			5	
On-Resistance Match Between Channels (Notes 3, 4)	ΔR _{ON}	V _{CC} = 3V; I _{COM₋} = 10mA; V _{NO₋} = 1.5V	T _A = +25°C		0.1	0.2	Ω
			T _A = -40°C to +85°C			0.25	
On-Resistance Flatness (Note 5)	R _{FLAT}	V _{CC} = 3V, I _{COM₋} = 10mA, V _{NO₋} = 1V, 2V, 3V	T _A = +25°C		1.2	1.8	Ω
			T _A = -40°C to +85°C			2	
NO ₋ Off-Leakage Current	I _{OFF}	V _{CC} = 5.5V, V _{NO₋} = 1V or 4.5V, V _{COM₋} = 4.5V or 1V	T _A = +25°C		-2	+2	nA
			T _A = -40°C to +85°C		-10	+10	
COM ₋ On-Leakage Current	I _{ON}	V _{CC} = 5.5V; V _{NO₋} = 1V, 4.5V, or floating; V _{COM₋} = 1V, 4.5V, or floating	T _A = +25°C		-2	+2	nA
			T _A = -40°C to +85°C		-12.5	+12.5	
-3dB Bandwidth	BW	Signal = 0dBm, R _L = 50Ω, C _L = 5pF, Figure 4			135		MHz

3.5Ω/7Ω、四路 SPST 开关， 可处理超摆幅信号

MAX4851/MAX4851H/MAX4853/MAX4853H

ELECTRICAL CHARACTERISTICS (continued)

(V_{CC} = +2.7V to +5.5V, T_A = -40°C to +85°C, unless otherwise noted. Typical values are at V_{CC} = +3.0V, T_A = +25°C, unless otherwise noted.) (Note 2)

PARAMETER	SYMBOL	CONDITIONS	MIN	TYP	MAX	UNITS
NO_ Off-Capacitance	C _{OFF}	f = 1MHz, Figure 5		20		pF
COM On-Capacitance	C _{ON}	f = 1MHz, Figure 5		40		pF
ANALOG SWITCH (7Ω Switch)						
Analog Signal Range	V _{NO_} , V _{COM_}		0		5.5	V
On-Resistance	R _{ON}	V _{CC} = 3V, I _{COM_} = 10mA, V _{NO_} = 0 to 5.5V (MAX485_) , or V _{CC} (MAX485_H)	T _A = +25°C	7	9	Ω
			T _A = -40°C to +85°C		10	
On-Resistance Match Between Channels (Notes 3, 4)	ΔR _{ON}	V _{CC} = 3V, I _{COM_} = 10mA, V _{NO_} = 1.5V	T _A = +25°C	0.2	0.4	Ω
			T _A = -40°C to +85°C		0.5	
On-Resistance Flatness (Note 5)	R _{FLAT}	V _{CC} = 3V; I _{COM_} = 10mA; V _{NO_} = 1V, 2V, 3V	T _A = +25°C	2.5	3.75	Ω
			T _A = -40°C to +85°C		4.0	
NO_ Off-Leakage Current	I _{OFF}	V _{CC} = 5.5V, V _{NO_} = 1V or 4.5V, V _{COM_} = 4.5V or 1V	T _A = +25°C	- 2	+2	nA
			T _A = -40°C to +85°C	-10	+10	
COM_ On-Leakage Current	I _{ON}	V _{CC} = 5.5V; V _{NO_} = 1V, 4.5V, or floating; V _{COM_} = 1V, 4.5V, or floating	T _A = +25°C	- 2	+2	nA
			T _A = -40°C to +85°C	- 12.5	+12.5	
-3dB Bandwidth	BW	Signal = 0dBm, R _L = 50Ω, C _L = 5pF, Figure 4		150		MHz
NO_ Off-Capacitance	C _{OFF}	f = 1MHz, Figure 5		13		pF
COM On-Capacitance	C _{ON}	f = 1MHz, Figure 5		30		pF
DYNAMIC CHARACTERISTICS						
Signal Over-Rail to High-Impedance Switching Time	t _{HIZ}	MAX4851H/MAX4853H, V _{NO_} = V _{CC} to (V _{CC} + 0.5V), V _{CC} < 5V, Figure 1		0.5	1	μs
High-Impedance to Low-Impedance Switching Time	t _{HIZB}	MAX4851H/MAX4853H, V _{NO_} = (V _{CC} + 0.5V) to V _{CC} , V _{CC} < 5V, Figure 1		0.5	1	μs
Skew (Note 3)	t _{SKEW}	R _S = 39Ω, C _L = 50pF, Figure 2		0.1	1	ns
Propagation Delay (Note 3)	t _{PD}	R _S = 39Ω, C _L = 50pF, Figure 2		0.9	2	ns
Turn-On Time	t _{ON}	V _{CC} = 3V, V _{NO_} = 1.5V, R _L = 300Ω, C _L = 50pF, Figure 1	T _A = +25°C	40	60	ns
			T _A = -40°C to +85°C		100	
Turn-Off Time	t _{OFF}	V _{CC} = 3V, V _{NO_} = 1.5V, R _L = 300Ω, C _L = 50pF, Figure 1	T _A = +25°C	30	40	ns
			T _A = -40°C to +85°C		60	
Charge Injection	Q	V _{COM_} = 1.5V, R _S = 0Ω, C _L = 1nF, Figure 3		8		pC

3.5Ω/7Ω、四路 SPST 开关， 可处理超摆幅信号

ELECTRICAL CHARACTERISTICS (continued)

($V_{CC} = +2.7V$ to $+5.5V$, $T_A = -40^{\circ}C$ to $+85^{\circ}C$, unless otherwise noted. Typical values are at $V_{CC} = +3.0V$, $T_A = +25^{\circ}C$, unless otherwise noted.) (Note 2)

PARAMETER	SYMBOL	CONDITIONS	MIN	TYP	MAX	UNITS
Off-Isolation (Note 6)		$f = 100kHz$, $V_{COM_} = 1V_{RMS}$, $R_L = 50\Omega$, $C_L = 5pF$, Figure 4		-80		dB
Crosstalk		$f = 1MHz$, $V_{COM_} = 1V_{RMS}$, $R_L = 50\Omega$, $C_L = 5pF$, Figure 4		-95		dB
Total Harmonic Distortion	THD	$f = 20Hz$ to $20kHz$, $V_{COM_} = 1V + 2VP-P$, $R_L = 600\Omega$		0.04		%
DIGITAL I/O (IN₋)						
Input Logic High Voltage	V_{IH}	$V_{CC} = 2V$ to $3.6V$	1.4			V
		$V_{CC} = 3.6V$ to $5.5V$	1.8			
Input Logic Low Voltage	V_{IL}	$V_{CC} = 2V$ to $3.6V$			0.5	V
		$V_{CC} = 3.6V$ to $5.5V$			0.8	
Input Leakage Current	I_{IN}	$V_{IN_} = 0$ or $5.5V$	-0.5		+0.5	μA
COMPARATOR						
Comparator Range			0		5.5	V
Comparator Threshold	V_{TH}	$V_{CC} = 2V$ to $5.5V$, falling input	$0.3 \times V_{CC}$	$0.33 \times V_{CC}$	$0.36 \times V_{CC}$	V
Comparator Hysteresis		$V_{CC} = 2V$ to $5.5V$		50		mV
Comparator Output High Voltage		$I_{SOURCE} = 1mA$	$V_{CC} - 0.4V$			V
Comparator Output Low Voltage		$I_{SINK} = 1mA$			0.4	V
Comparator Switching Time		Rising input, Figure 6		2.5		μs
		Falling input, Figure 6		0.5		

Note 2: Specifications are 100% tested at $T_A = +85^{\circ}C$ only, and guaranteed by design and characterization over the specified temperature range.

Note 3: Guaranteed by design and characterization; not production tested.

Note 4: $\Delta R_{ON} = R_{ON(MAX)} - R_{ON(MIN)}$.

Note 5: Flatness is defined as the difference between the maximum and minimum value of on-resistance as measured over the specified analog signal ranges.

Note 6: Off-isolation = $20 \log_{10} (V_{COM_} / V_{NO_})$, $V_{COM_}$ = output, $V_{NO_}$ = input to off switch.

3.5Ω/7Ω、四路 SPST 开关， 可处理超摆幅信号

典型工作特性

($V_{CC} = 3.0V$, $T_A = +25^\circ C$, unless otherwise noted.)

MAX4851/MAX4851H/MAX4853/MAX4853H

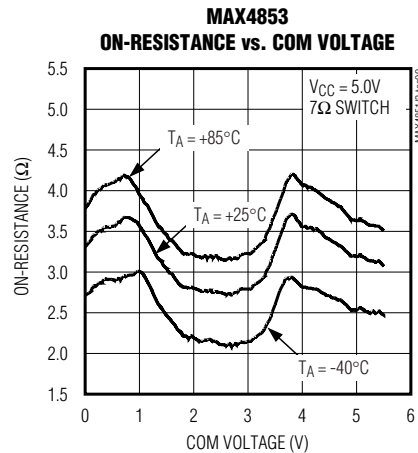
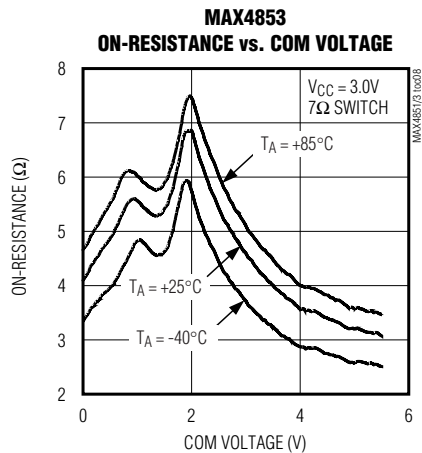
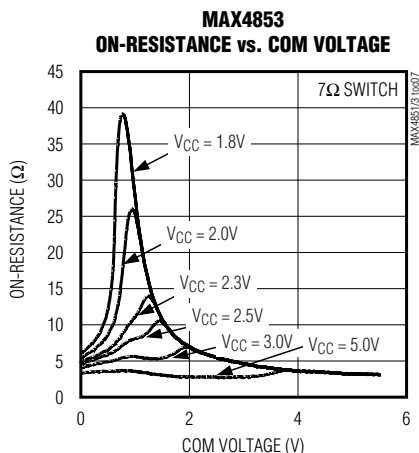
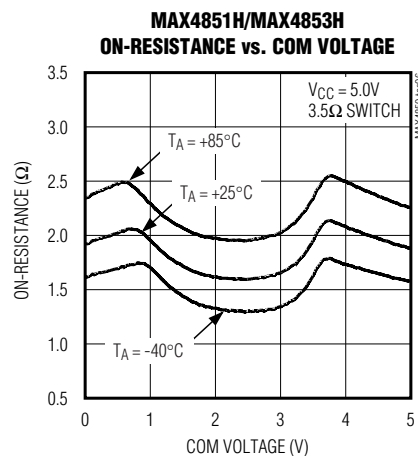
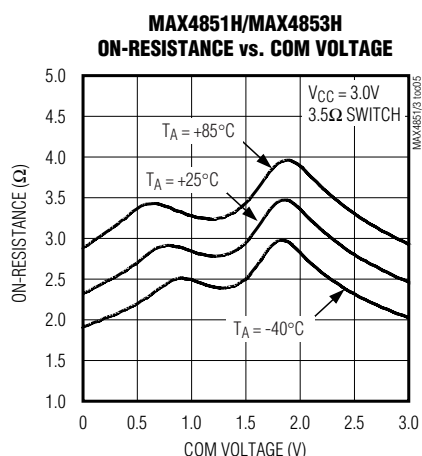
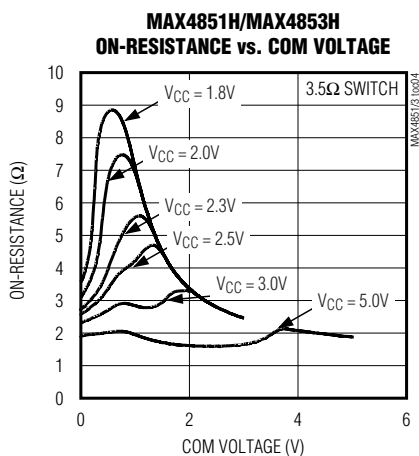
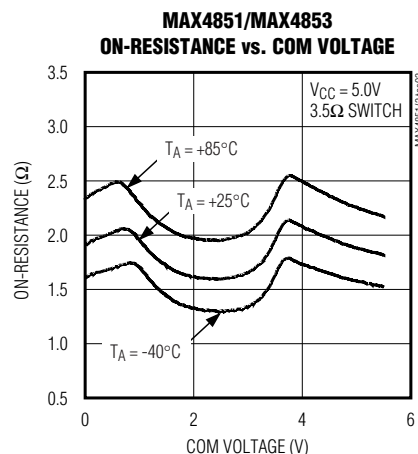
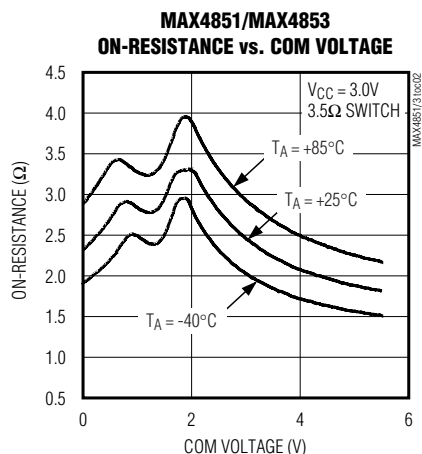
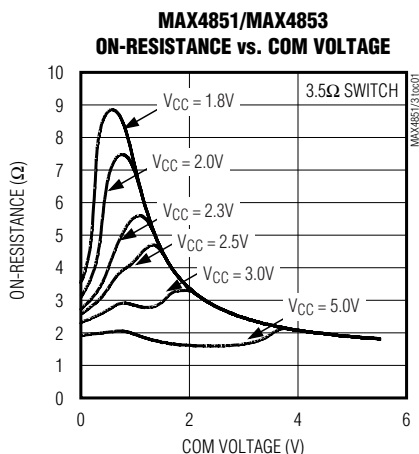

3.5Ω/7Ω、四路 SPST 开关， 可处理超摆幅信号

典型工作特性(续)

($V_{CC} = 3.0V$, $T_A = +25^\circ C$, unless otherwise noted.)

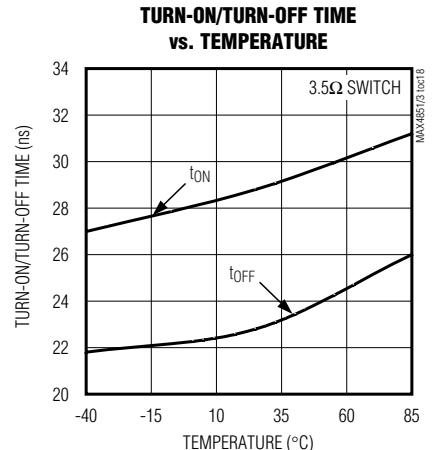
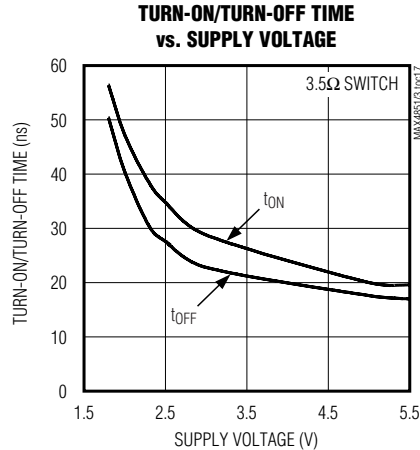
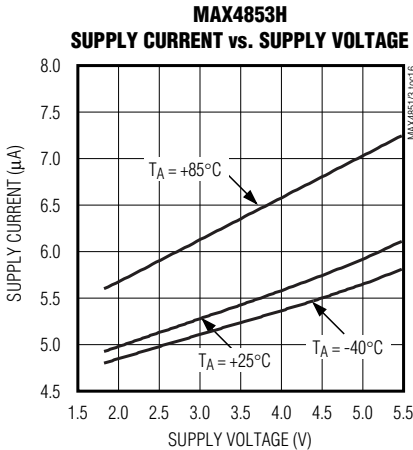
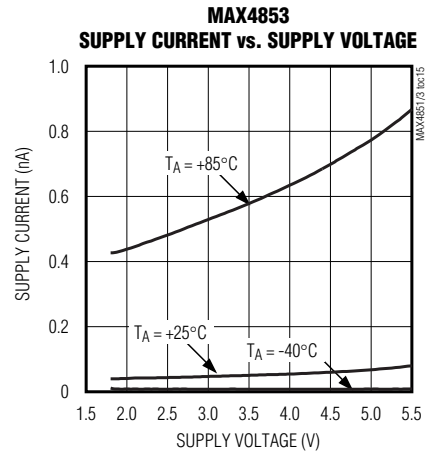
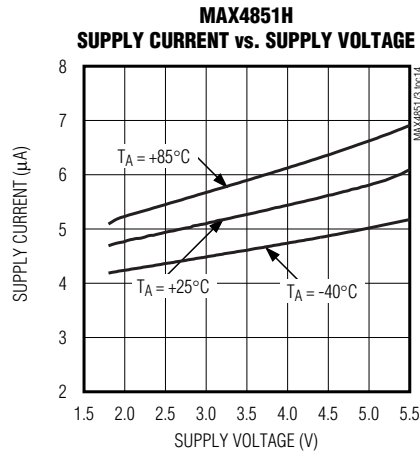
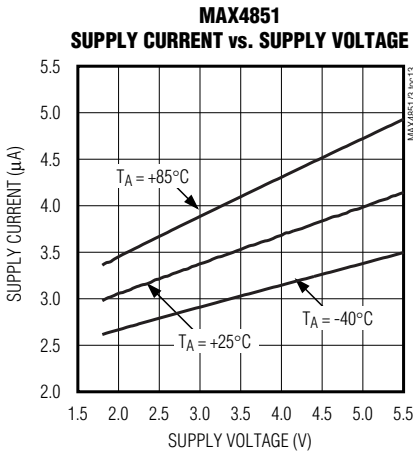
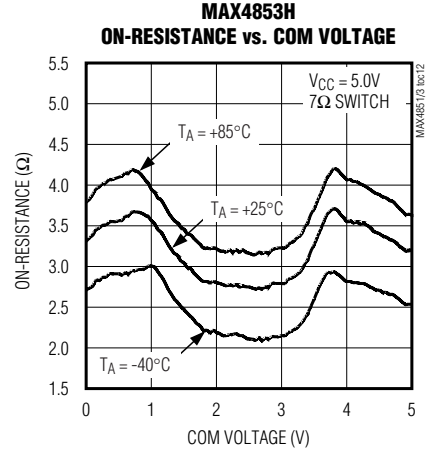
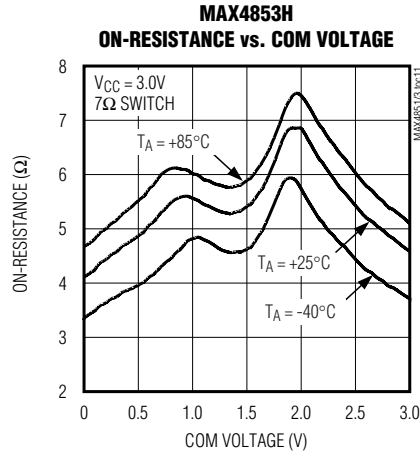
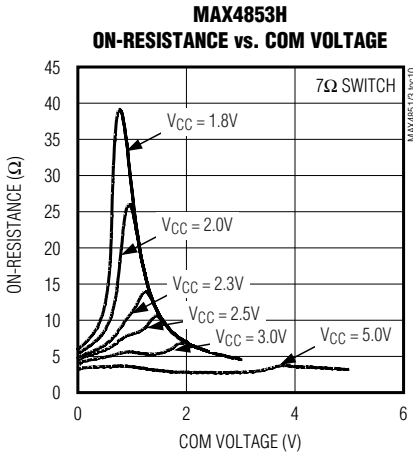

3.5Ω/7Ω、四路 SPST 开关， 可处理超摆幅信号

典型工作特性 (续)

($V_{CC} = 3.0V$, $T_A = +25^{\circ}C$, unless otherwise noted.)

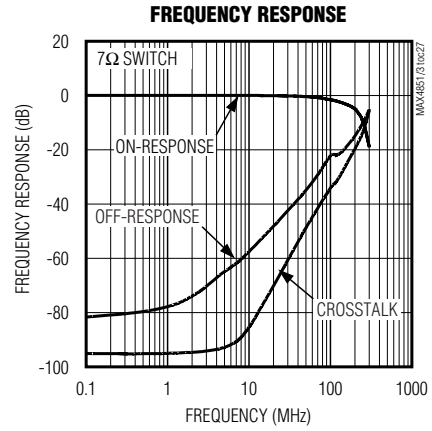
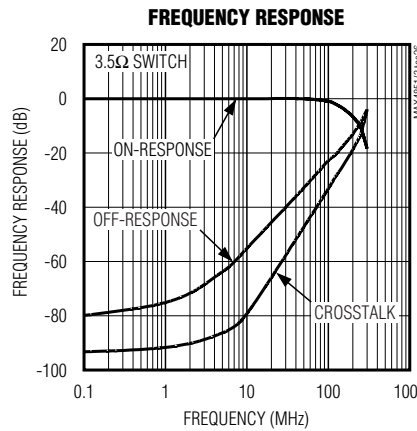
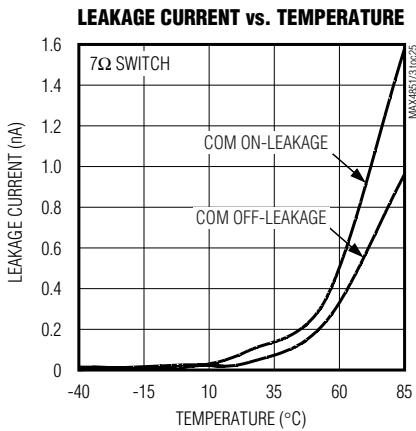
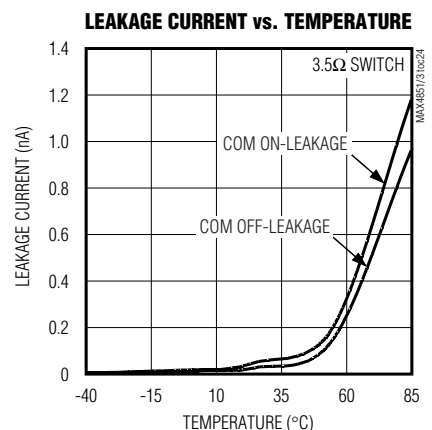
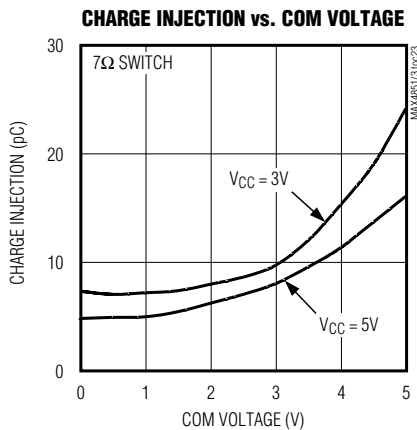
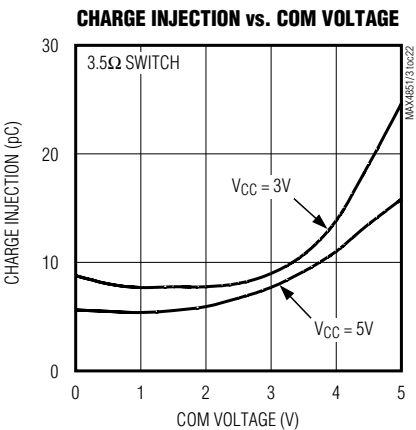
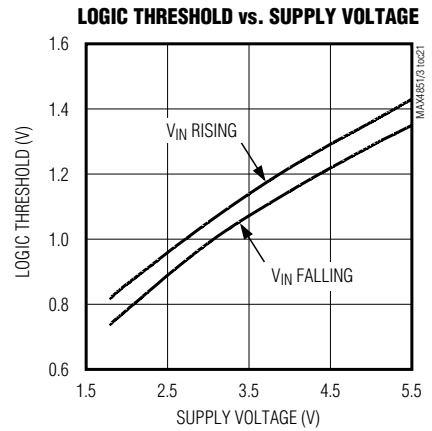
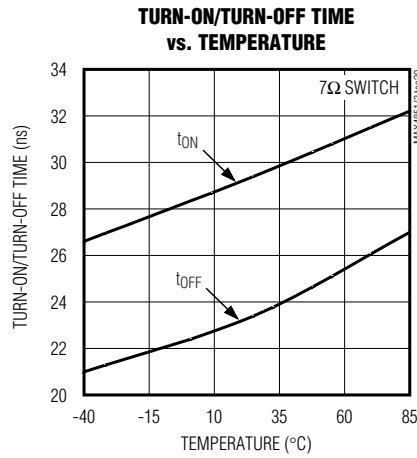
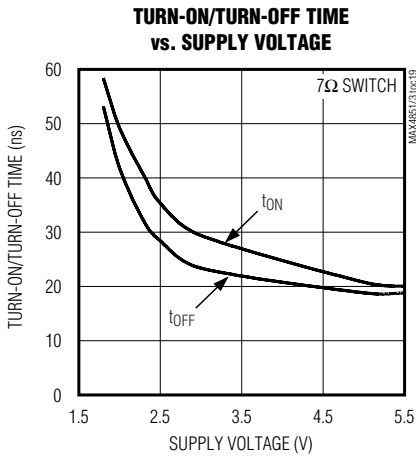

MAX4851/MAX4851H/MAX4853/MAX4853H

3.5Ω/7Ω、四路 SPST 开关， 可处理超摆幅信号

典型工作特性 (续)

($V_{CC} = 3.0V$, $T_A = +25^\circ C$, unless otherwise noted.)

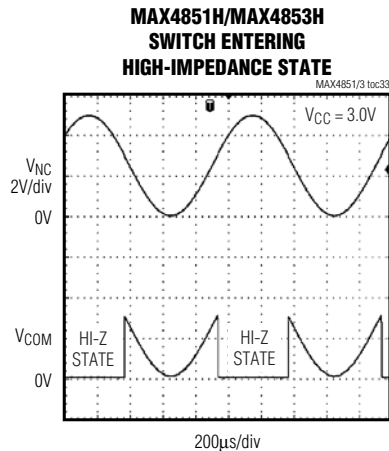
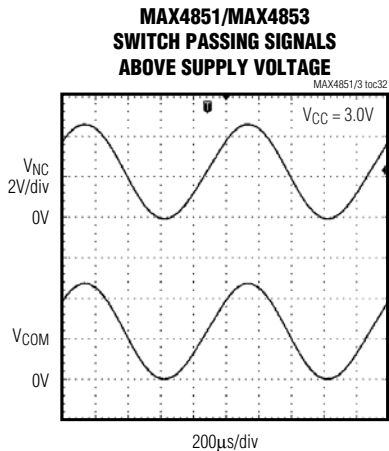
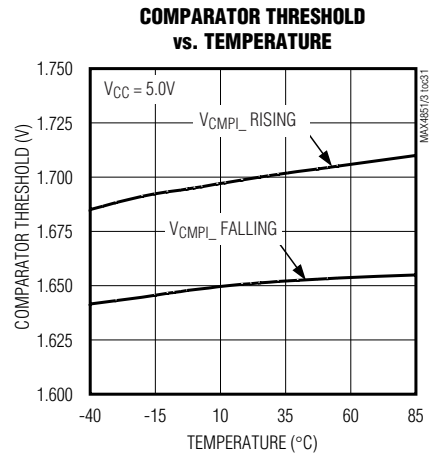
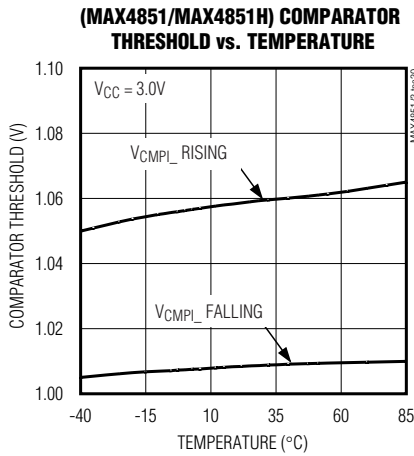
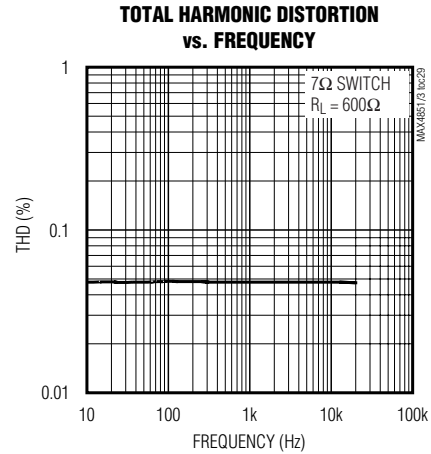
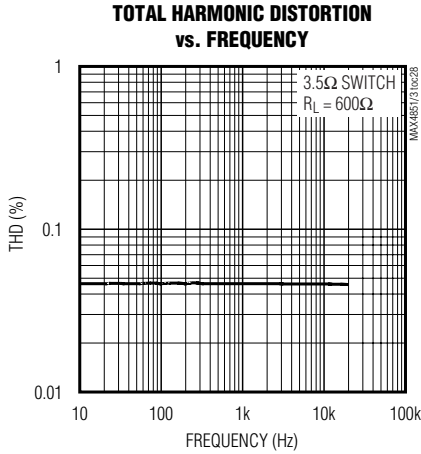

3.5Ω/7Ω、四路 SPST 开关， 可处理超摆幅信号

引脚说明

MAX4851/MAX4851H/MAX4853/MAX4853H

引脚		名称	功能
MAX4851 MAX4851H	MAX4853 MAX4853H		
1	1	NO1	模拟开关 1 的常开端
2	—	CIN	比较器的反相输入
3	3	IN2	模拟开关 2 的数字控制输入。IN2 为逻辑低时断开 COM2 和 NO2；IN2 为逻辑高时接通 COM2 和 NO2。
4	4	COM2	模拟开关 2 的公共端
5	5	NO2	模拟开关 2 的常开端
6	6	GND	地
7	7	NO3	模拟开关 3 的常开端
8	8	COM3	模拟开关 3 的公共端
9	9	IN3	模拟开关 3 的数字控制输入。IN3 为逻辑低时断开 COM3 和 NO3；IN3 为逻辑高时接通 COM3 和 NO3。
10	10	NO4	模拟开关 4 的常开端
11	—	COU	比较器的输出
12	12	COM4	模拟开关 4 的公共端
13	13	IN4	模拟开关 4 的数字控制输入。IN4 为逻辑低时断开 COM4 和 NO4；IN4 为逻辑高时接通 COM4 和 NO4。
14	14	VCC	电源电压。用一个尽可能靠近该引脚的 0.01μF 电容旁路至 GND。
15	15	IN1	模拟开关 1 的数字控制输入。IN1 为逻辑低时断开 COM1 和 NO1；IN1 为逻辑高时接通 COM1 和 NO1。
16	16	COM1	模拟开关 1 的公共端
—	2, 11	N.C.	未接。内部无连接。
EP	EP	GND	裸露焊盘。接地。

详细说明

MAX4851/MAX4851H/MAX4853/MAX4853H 是低导通电阻、低电压、工作在 +2V 至 +5.5V 单电源的模拟开关，完全规范于电源标称值为 3.0V 的应用。MAX4851/MAX4853 具有超摆幅信号处理能力，在电源电压降至 2.0V 时，仍然允许高达 5.5V 的信号无失真地通过。对于 MAX4851H/MAX4853H，当信号电压超过 V_{CC} 时器件进入高阻模式，当信号电压降至低于 V_{CC} 时器件恢复正常工作。

这些四路 SPST 开关具有低导通电容，能够切换 USB 2.0/1.1 应用中 (12Mbps) 的数据信号。它们设计用来切换 USB 的 D+ 和 D- 信号，并能保证在输入信号的 50% 和输出信号的 50% 处测量的偏差小于 1ns (见图 2)。

MAX4851_ 具有一个比较器，可用于耳机或静音检测。比较器的门限值由内部设定，约为 V_{CC} 的 1/3。

3.5Ω/7Ω、四路 SPST 开关， 可处理超摆幅信号

测试电路/时序图 (续)

MAX4851/MAX4851H/MAX4853/MAX4853H



图 3. 电荷注入



图 4. 导通损耗、关断隔离和串扰

3.5Ω/7Ω、四路 SPST 开关， 可处理超摆幅信号

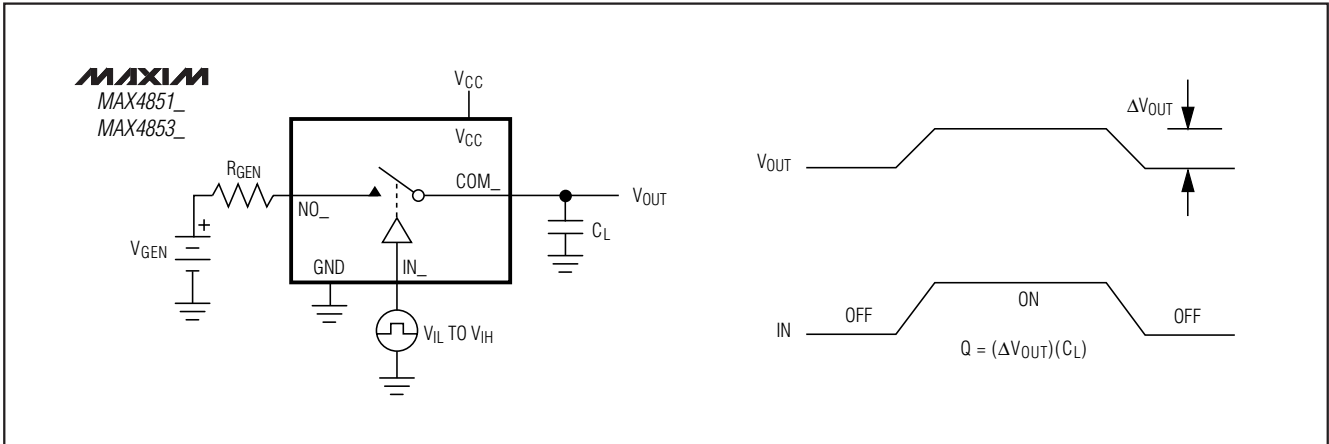
应用信息

数字控制输入

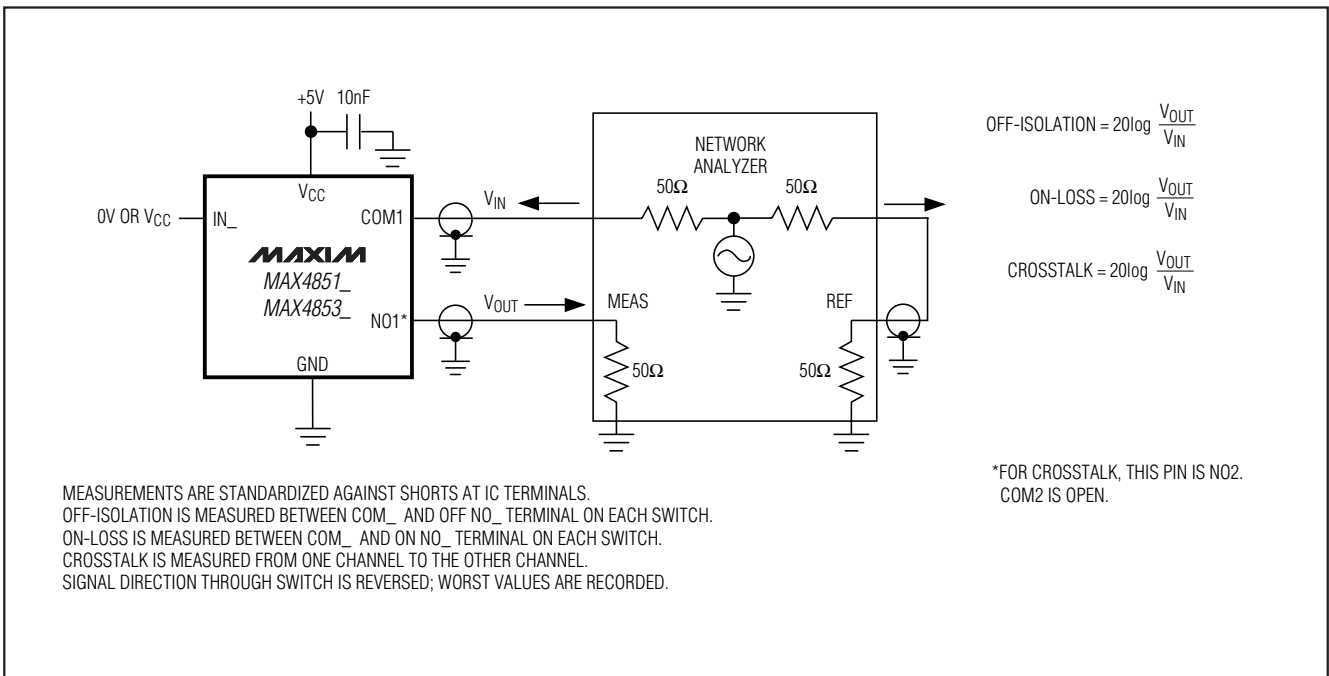
逻辑输入 (IN₋) 可接受高达 +5.5V 的电压，即使电源电压低于这个电平。例如，V_{CC} 电源为 +3.3V 时，IN₋ 输入可低至 GND，最高可达 +5.5V，这样就允许多种逻辑电平共存于同一系统中。满摆幅驱动 IN₋ 可使功耗降至最低。对于 +2V 电源电压，逻辑门限值为 0.5V (低) 和 1.4V (高)；对于 +5V 电源电压，逻辑门限值是 0.8V (低) 和 1.8V (高)。

模拟信号电平

当模拟输入信号在整个电源电压范围内变化时，这些开关的导通电阻变化极小 (见典型工作特性)。这些开关是双向的，因此 NO₋ 和 COM₋ 既可做输入也可做输出。

比较器

比较器的同相输入端内部设置为 V_{CC} / 3。当比较器反相端 (CIN₋) 低于该门限值时 (V_{CC} / 3)，比较器的输出 (COUT₋) 变高。当 CIN₋ 上升到超过 V_{CC} / 3 时，COUT₋ 变低。

比较器的门限值可用于耳机检测，这是因为典型情况下，耳机音频信号是偏置到 V_{CC} / 2 的。



图 5. 通道关/开电容

供电顺序

警告： 加载电压不要超过极限参数，因为超过列出的极限参数可能引起器件永久损坏。

对于所有 CMOS 器件，推荐使用正确的供电顺序。总是在加模拟信号之前先加 V_{CC}，特别是在模拟信号没有限流的情况下。

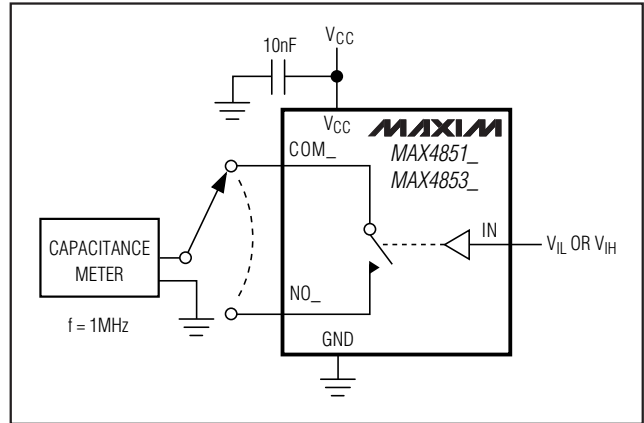

图 6. 比较器切换时间

选择指南

PART	RON (Ω)		COMPARATORS	OVER-RAIL HANDLING
	NO1/NO3	NO2/NO4		
MAX4851	3.5	3.5	1	Input signal passes through the switch.
MAX4851H	3.5	3.5	1	High-impedance switch input.
MAX4853	3.5	7	—	Input signal passes through the switch.
MAX4853H	3.5	7	—	High-impedance switch input.

3.5Ω/7Ω、四路 SPST 开关， 可处理超摆幅信号

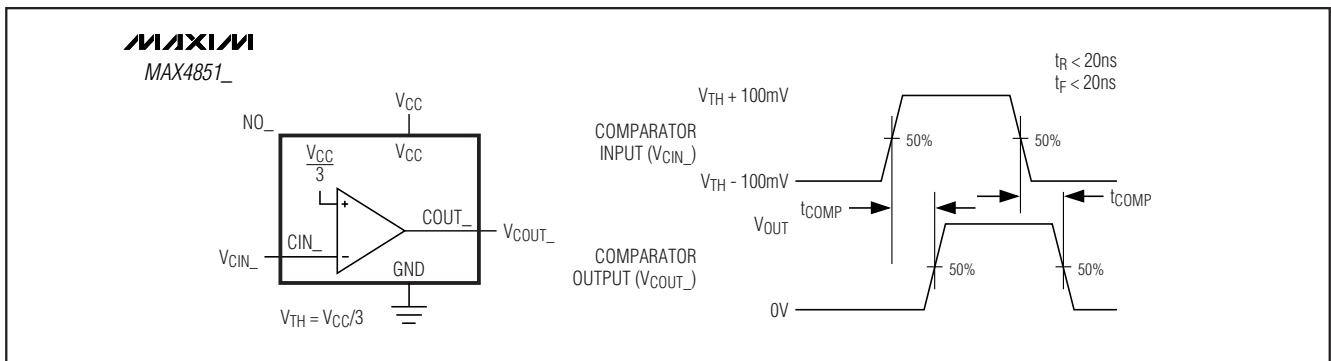
引脚配置

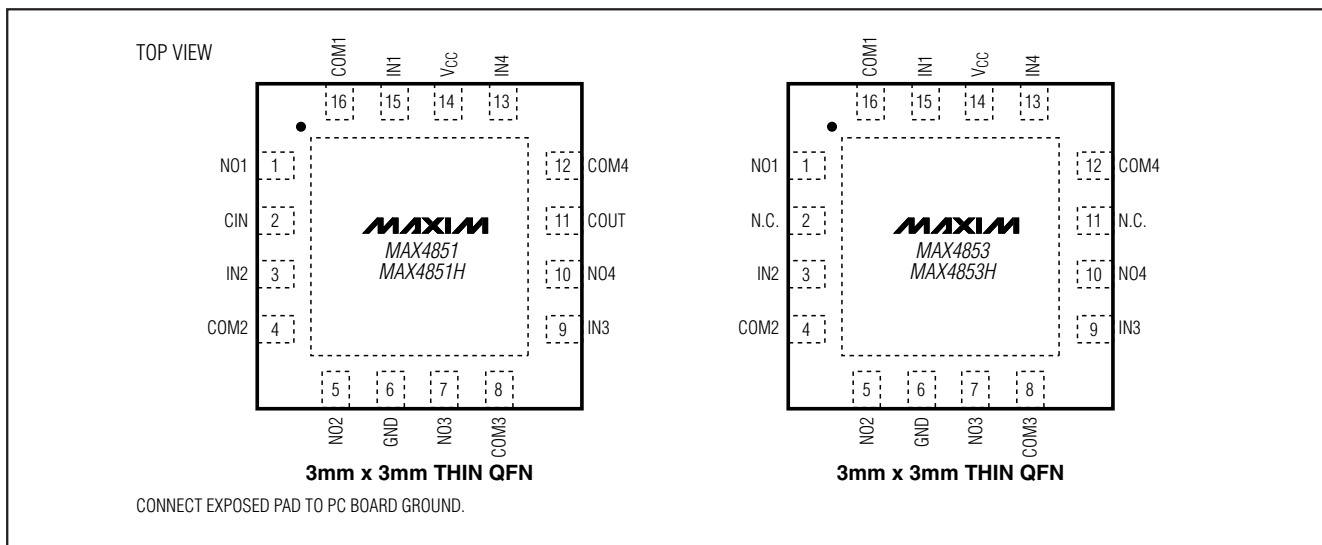

典型工作电路

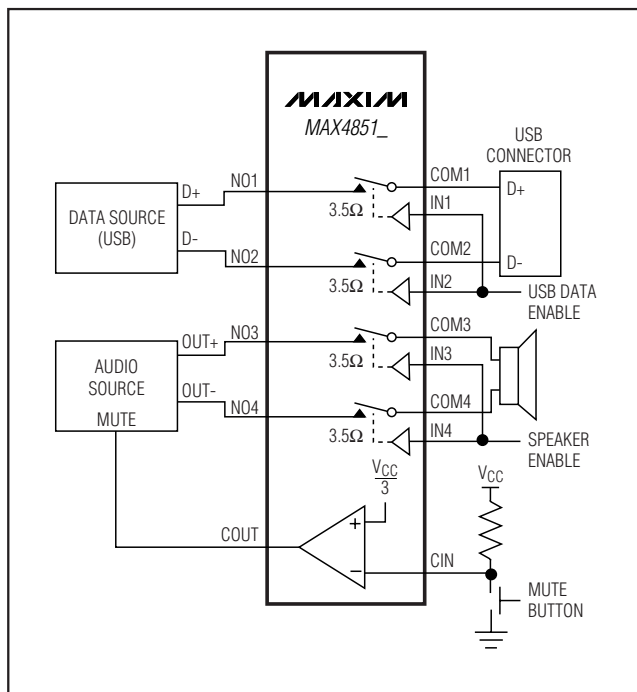

芯片信息

TRANSISTOR COUNT: 735
PROCESS: CMOS

MAX4851/MAX4851H/MAX4853/MAX4853H

3.5Ω/7Ω、四路 SPST 开关， 可处理超摆幅信号

封装信息

(本数据资料提供的封装图可能不是最近的规格，如需最近的封装外型信息，请查询 www.maxim-ic.com.cn/packages。)

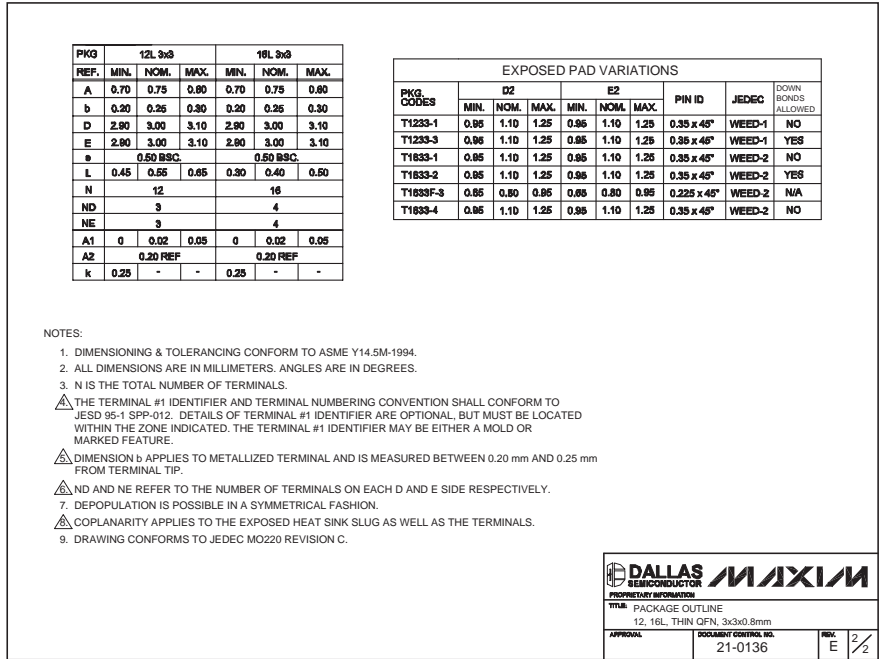
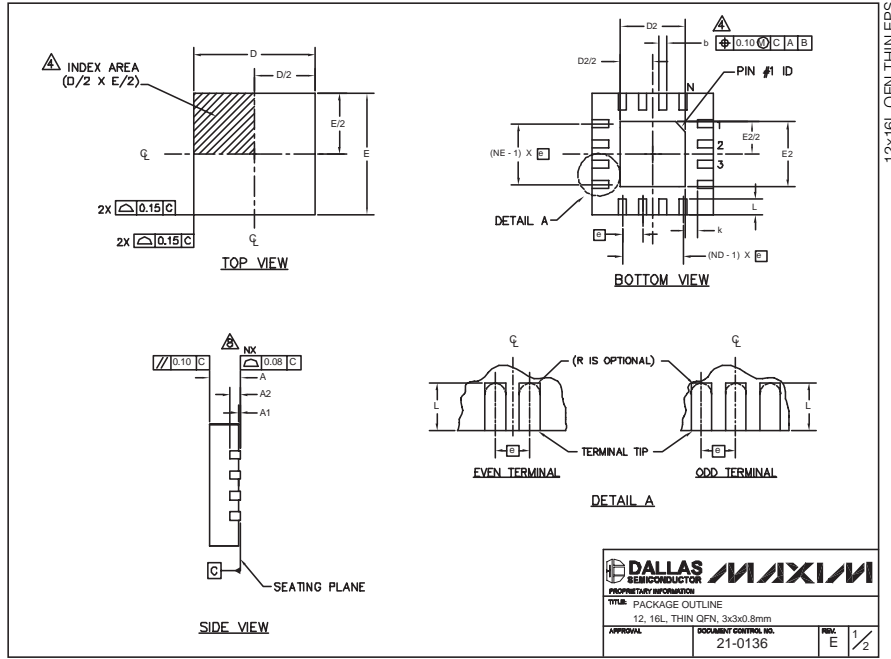

Maxim 不对 Maxim 产品以外的任何电路使用负责，也不提供其专利许可。Maxim 保留在任何时间、没有任何通报的前提下修改产品资料和规格的权利。