The Hardware Book

by Joakim Ögren

Welcome to the Hardware Book. Your electronic reference guide.

Created and maintained by Joakim Ögren.

This is the PDF (Adobe Acrobat) version. It's converted from HTML to PDF so the result may sometimes look a bit strange. Please let me know if you find any major visual errors.

You'll find the online version and the latest PDF version at HwB

<<http://www.blackdown.org/~hwb/hwb.html>>.

Current version 1.2 BETA.

Converted from HTML 1997-09-07.

Contents:

Connectors	Pinouts for connectors, buses etc.
Connectors Top 10	Too many? These are the most common.
Cables	How to build serial cables and many other cables.
Adapters	How to build adapters.
Circuits	Coming soon.
Misc	Misc information (active filters etc).
Tables	Misc tables with info. (AWG..)
Download	Download a WinHelp or HTML version for offline viewing.
HwB-News	Subscribe to the HwB Newsletter! Info about updates etc.
Wanted	Information I'm currently looking for.
About	Who did this? And why?

Note: This PDF file may NOT be sold in printed form or as a file.

(C) Joakim Ögren <qtech@mailhost.net> 1996, 1997

BETA RELEASE

Chapter 1

Connector Menu

What does the the information that is listed for each connector mean? See the tutorial.

Buses:

- ISA **UPDATED** - (Technical) **UPDATED**
- EISA - (Technical)
- PCI - (Technical)
- VESA LocalBus (VLB) - (Technical)
- CompactPCI - (Technical)
- IndustrialPCI
- SmallPCI
- Miniature Card - (Technical)
- NuBus
- NuBus 90
- Zorro II
- Zorro II/III
- CPU-port (A1200)
- Ramex (A1000)
- Video Expansion (Amiga)
- CD32 Expansion
- CardBus
- PC Card
- PC Card ATA
- PCMCIA
- CompactFlash
- C-bus II
- SSFDC
- PC-104
- Unibus **NEW**

Serial In/Out:

- RS-232 **UPDATED**
- Serial (PC 9)
- Serial (PC 25)
- Serial (Amiga 1000)
- Serial (Amiga)
- Serial (MSX)

BETA RELEASE

Chapter 1: Connector Menu

- Serial (Printer) **NEW**
- DEC Dual RS-232
- Macintosh RS-422
- RS-422 **NEW**
- Macintosh Serial
- C64 RS232 User Port
- DEC DLV11-J Serial
- Cisco Console Port **NEW**
- RocketPort Serialport **NEW**
- CoCo Serial Printer **NEW**
- Conrad Electronics MM3610D **NEW**

Parallel In/Out:

- Parallel (PC) **UPDATED**
- Parallel (Amiga) **UPDATED**
- Parallel (Amiga 1000)
- ECP Parallel **UPDATED** - (Technical)
- Centronics Printer **UPDATED**
- MSX Parallel
- Parallel (Olivetti M10)
- Amstrad CPC6128 Printer Port **NEW**

Misc In/Out:

- Universal Serial Bus (USB) **NEW** - (Technical)
- BeBox GeekPort
- C64/C16/C116/+4 Serial I/O
- Atari ACSI DMA

Video:

- VGA (VESA DDC)
- VGA (15)
- VGA (9)
- CGA
- EGA
- PGA
- MDA (Hercules)
- VESA Feature
- Macintosh Video **UPDATED**
- Amiga Video
- RF Monitor (Amiga 1000)
- CDTV Video Slot
- PlayStation A/V
- Commodore 1084 & 1084S (Analog)
- Commodore 1084 & 1084S (Digital)
- Commodore 1084d & 1084dS
- Atari Jaguar A/V
- SNES Video
- NeoGeo Audio/Video **UPDATED**
- Amstrad CPC6128 Monitor **NEW**
- Amstrad CPC6128 Plus Monitor **UPDATED**

BETA RELEASE

Chapter 1: Connector Menu

- Atari ST Monitor
- Sun Video
- ZX Spectrum 128 RGB
- 3b1-7300 Video
- CM-8/CoCo RGB
- AT&T 53D410
- AT&T 6300 Taxan Monitor
- AT&T PC6300
- Vic 20 Video
- C64 Audio/Video
- C65 Video
- C128 RGBI
- C128/C64C Video
- C16/C116/+4
- CBM 1902A
- Spectravideo SVI318/328 Audio/Video **NEW**

Joysticks/Mouses:

- PC Gameport
- PC Gameport+MIDI
- Amiga Mouse/Joy
- C64 Control Port
- C16/C116/+4 Joystick
- MSX Joystick
- SGI Mouse (Model 021-0004-002)
- Macintosh Mouse
- Atari Mouse/Joy
- Atari Enhanced Joystick
- Atari 2600 Joystick
- Atari 6200 Joystick
- Atari 7800 Joystick
- Amstrad Digital/Joystick **UPDATED**
- NeoGeo Joystick

Keyboards:

- Keyboard (5 PC)
- Keyboard (6 PC)
- Keyboard (XT)
- Keyboard (5 Amiga)
- Keyboard (6 Amiga)
- Keyboard (Amiga CD32)
- Macintosh Keyboard
- AT&T 6300 Keyboard

Diskdrives:

- Internal Diskdrive
- 8" Floppy Diskdrive **UPDATED**
- External Diskdrive (Amiga)
- MSX External Diskdrive
- Amstrad CPC6128 Diskdrive 2 **NEW**

BETA RELEASE

Chapter 1: Connector Menu

- Amstrad CPC6128 Plus External Diskdrive **UPDATED**
- Macintosh External Drive
- Atari Floppy Port

Harddrives:

- SCSI Internal (Single-ended)
- SCSI Internal (Differential)
- SCSI External Centronics 50 (Single-ended)
- SCSI External Centronics 50 (Differential)
- SCSI-II External Hi D-Sub Connector (Single-ended)
- SCSI-II External Hi D-Sub Connector (Differential)
- SCSI External D-Sub (Future Domain)
- SCSI External D-Sub (PC/Amiga/Mac)
- Novell and Procomp External SCSI **NEW**
- IDE Internal **UPDATED**
- ATA Internal
- ATA (44) Internal
- ESDI
- ST506/412
- Paravision SX-1 External IDE

Misc data storage:

- Mitsumi CD-ROM
- Panasonic CD-ROM
- Sony CD-ROM
- C64 Cassette
- C16/C116/+4 Cassette
- CoCo Cassette
- MSX Cassette
- Spectravideo SVI318/328 Cassette **NEW**
- Amstrad CPC6128 Tape **NEW**

Memories:

- 30 pin SIMM
- 72 pin SIMM
- 72 pin ECC SIMM
- 72 pin SO DIMM **UPDATED**
- 144 pin SO DIMM
- 168 pin DRAM DIMM (Unbuffered)
- 168 pin SDRAM DIMM (Unbuffered)
- CDTV Memory Card
- SmartCard AFNOR
- SmartCard ISO 7816-2
- SmartCard ISO

Home audio/video:

- SCART
- S-Video
- DIN Audio
- 3.5 mm Mono Telephone plug **NEW**

BETA RELEASE

Chapter 1: Connector Menu

- 3.5 mm Stereo Telephone plug **NEW**
- 6.25 mm Mono Telephone plug **NEW**
- 6.25 mm Stereo Telephone plug **NEW**

PC motherboards:

- 5.25" Power **UPDATED**
- 3.5" Power
- Motherboard Power
- Turbo LED
- AT Backup Battery
- AT LED/Keylock
- PC-Speaker
- Motherboard IrDA **NEW**
- Motherboard CPU Cooling fan **NEW**

Networking:

- Ethernet 10Base-T & 100Base-T **UPDATED**
- Ethernet 100Base-T4 **NEW**
- AUI

Cartridge/Expansion:

- Atari 2600 Cartridge
- Atari 5200 Cartridge
- Atari 5200 Expansion
- Atari 7800 Cartridge
- Atari 7800 Expansion
- Atari Cartridge Port
- GameBoy Cartridge
- MSX Expansion
- Vic 20 Memory Expansion
- C64 Cartridge
- C64 User Port
- C128 Expansion Bus **NEW**
- C16/+4 Expansion Bus
- +4 User Port
- CDTV Diagnostic Slot
- CDTV Expansion Slot
- PC-Engine Cartridge
- SNES Cartridge
- TG-16 Cartridge
- ZX Spectrum AY-3-8912
- ZX Spectrum ULA
- Spectravideo SVI318/328 Expansion Bus **NEW**
- Spectravideo SVI318/328 Game Cartridge **NEW**

Misc:

- MIDI Out
- MIDI In
- Minuteman UPS
- C64 Power Supply Connector **NEW**

BETA RELEASE

Chapter 1: Connector Menu

- Amstrad CPC6128 Stereo Connector **NEW**

Last updated 1997-09-01.

(C) Joakim Ögren <qtech@mailhost.net> 1996, 1997

PRELIMINARY BETA. NOT FOR REDISTRIBUTION.

BETA RELEASE

Short tutorial

Heading

First at each page there a short heading describing what the connector is.

Pictures of the connectors

After that there is at each page there is one or more pictures of the connectors. Sometimes there is some question marks only. This means that I don't know what kind of connector it is or how it looks.

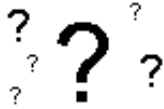

(At the computer)

There may be some pictures I haven't drawn yet. I illustrate this with the following advanced picture:

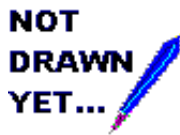

(At the computer)

Normally are one or more pictures. **These are seen from the front, and NOT the soldside. Holes (female connectors usually) are darkened.** Look at the example below. The first is a female connector and the send a male. The texts insde parentheses will tell you at which kind of the device it will look like that.

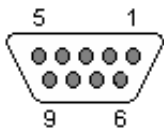

(At the videocard)

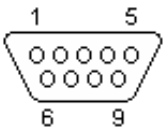

(At the monitor cable)

Texts describing the connectors

Below the pictures there is texts that describes the connectors. Including the name of the physical connector.

5 PIN DIN 180° (DIN41524) at the computer.

Pin table

The pin table is perhaps the information you're looking for. Should be simple to read. Contains mostly the following three columns; Pin, Name & Description.

Pin	Name	Description
1	CLOCK	Key Clock
2	GND	GND
3	DATA	Key Data
4	VCC	+5 VDC
5	n/c	Not connected

Contributor & Source

BETA RELEASE

All persons that helped me or sent me information about the connector will be listed here. The source of the information is perhaps a book or another site. I must admit that I'm bad at writing the source, but I'll try to fill in these in the future.

Contributor: Joakim Ögren <qtech@mailhost.net>

Source: Amiga 4000 User's Guide from Commodore

The Hardware Book is freely distributable but is copyrighted to Joakim Ögren. It may not be modified and re-distributed without the authors permission.

PRELIMINARY BETA. NOT FOR REDISTRIBUTION.

BETA RELEASE

ISA

ISA=Industry Standard Architecture

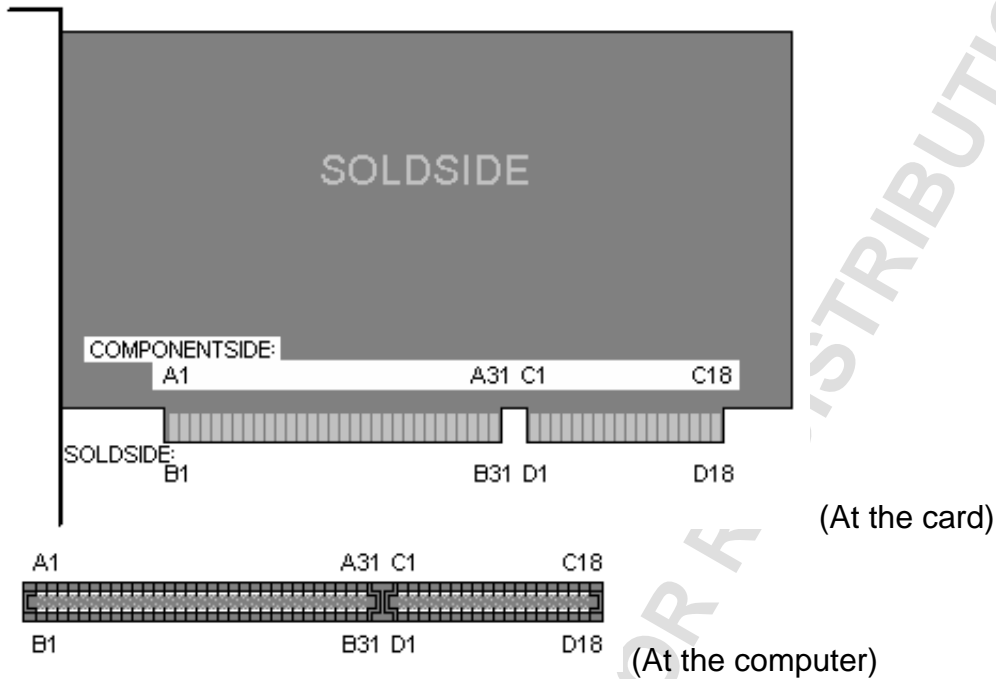







62+36 PIN EDGE CONNECTOR MALE at the card.

62+36 PIN EDGE CONNECTOR FEMALE at the computer.

Pin	Name	Dir	Description
A1	I/O CH CK	↑	I/O channel check; active low=parity error
A2	D7	↕	Data bit 7
A3	D6	↕	Data bit 6
A4	D5	↕	Data bit 5
A5	D4	↕	Data bit 4
A6	D3	↕	Data bit 3
A7	D2	↕	Data bit 2
A8	D1	↕	Data bit 1
A9	D0	↕	Data bit 0
A10	I/O CH RDY	↑	I/O Channel ready, pulled low to lengthen memory cycles
A11	AEN	↑	Address enable; active high when DMA controls bus
A12	A19	→	Address bit 19
A13	A18	→	Address bit 18
A14	A17	→	Address bit 17
A15	A16	→	Address bit 16
A16	A15	→	Address bit 15
A17	A14	→	Address bit 14
A18	A13	→	Address bit 13
A19	A12	→	Address bit 12
A20	A11	→	Address bit 11
A21	A10	→	Address bit 10
A22	A9	→	Address bit 9
A23	A8	→	Address bit 8
A24	A7	→	Address bit 7
A25	A6	→	Address bit 6
A26	A5	→	Address bit 5
A27	A4	→	Address bit 4
A28	A3	→	Address bit 3
A29	A2	→	Address bit 2
A30	A1	→	Address bit 1

A31	A0	→	Address bit 0
B1	GND		Ground
B2	RESET	→	Active high to reset or initialize system logic
B3	+5V		+5 VDC
B4	IRQ2	↑	Interrupt Request 2
B5	-5VDC		-5 VDC
B6	DRQ2	↑	DMA Request 2
B7	-12VDC		-12 VDC
B8	/NOWS	↑	No WaitState
B9	+12VDC		+12 VDC
B10	GND		Ground
B11	/SMEMW	→	System Memory Write
B12	/SMEMR	→	System Memory Read
B13	/IOW	→	I/O Write
B14	/IOR	→	I/O Read
B15	/DACK3	→	DMA Acknowledge 3
B16	DRQ3	↑	DMA Request 3
B17	/DACK1	→	DMA Acknowledge 1
B18	DRQ1	↑	DMA Request 1
B19	/REFRESH	↔	Refresh
B20	CLOCK	→	System Clock (67 ns, 8-8.33 MHz, 50% duty cycle)
B21	IRQ7	↑	Interrupt Request 7
B22	IRQ6	↑	Interrupt Request 6
B23	IRQ5	↑	Interrupt Request 5
B24	IRQ4	↑	Interrupt Request 4
B25	IRQ3	↑	Interrupt Request 3
B26	/DACK2	→	DMA Acknowledge 2
B27	T/C	→	Terminal count; pulses high when DMA term. count reached
B28	ALE	→	Address Latch Enable
B29	+5V		+5 VDC
B30	OSC	→	High-speed Clock (70 ns, 1431818 MHz, 50% duty cycle)
B31	GND		Ground
C1	SBHE	↔	System bus high enable (data available on SD8-15)
C2	LA23	↔	Address bit 23
C3	LA22	↔	Address bit 22
C4	LA21	↔	Address bit 21
C5	LA20	↔	Address bit 20
C6	LA18	↔	Address bit 19
C7	LA17	↔	Address bit 18
C8	LA16	↔	Address bit 17
C9	/MEMR	↔	Memory Read (Active on all memory read cycles)
C10	/MEMW	↔	Memory Write (Active on all memory write cycles)
C11	SD08	↔	Data bit 8
C12	SD09	↔	Data bit 9
C13	SD10	↔	Data bit 10
C14	SD11	↔	Data bit 11
C15	SD12	↔	Data bit 12
C16	SD13	↔	Data bit 13
C17	SD14	↔	Data bit 14
C18	SD15	↔	Data bit 15
D1	/MEMCS16	↑	Memory 16-bit chip select (1 wait, 16-bit memory cycle)
D2	/IOCS16	↑	I/O 16-bit chip select (1 wait, 16-bit I/O cycle)
D3	IRQ10	↑	Interrupt Request 10
D4	IRQ11	↑	Interrupt Request 11
D5	IRQ12	↑	Interrupt Request 12
D6	IRQ15	↑	Interrupt Request 15
D7	IRQ14	↑	Interrupt Request 14
D8	/DACK0	→	DMA Acknowledge 0
D9	DRQ0	↑	DMA Request 0

BETA RELEASE

D10	/DACK5		DMA Acknowledge 5
D11	DRQ5		DMA Request 5
D12	/DACK6		DMA Acknowledge 6
D13	DRQ6		DMA Request 6
D14	/DACK7		DMA Acknowledge 7
D15	DRQ7		DMA Request 7
D16	+5 V		
D17	/MASTER		Used with DRQ to gain control of system
D18	GND		Ground

Note: Direction is Motherboard relative ISA-Cards.

Note: B8 was /CARD SLCDTD on the XT. Card selected, activated by cards in XT's slot J8

Contributor: Joakim Ögren <qtech@mailhost.net>

Sources: IBM PC/AT Technical Reference, pages 1-25 through 1-37

Sources: comp.sys.ibm.pc.hardware. FAQ Part 4*

<ftp://rtfm.mit.edu/pub/usenet/news.answers/pc-hardware-faq/part1>, maintained by Ralph Valentino <ralf@alum.wpi.edu>

Please send any comments to Joakim Ögren <qtech@mailhost.net>.

PRELIMINARY BETA. NOT FOR REDISTRIBUTION.

ISA (Technical)

This file is designed to give a basic overview of the bus found in most IBM clone computers, often referred to as the XT or AT bus. The AT version of the bus is upwardly compatible, which means that cards designed to work on an XT bus will work on an AT bus. This bus was produced for many years without any formal standard. In recent years, a more formal standard called the ISA bus (Industry Standard Architecture) has been created, with an extension called the EISA (Extended ISA) bus also now as a standard. The EISA bus extensions will not be detailed here.

This file is not intended to be a thorough coverage of the standard. It is for informational purposes only, and is intended to give designers and hobbyists sufficient information to design their own XT and AT compatible cards.

Physical Design:

ISA cards can be either 8-bit or 16-bit. 8-bit cards only uses the first 62 pins and 16-bit cards uses all 98 pins. Some 8-bit cards uses some of the 16-bit extension pins to get more interrupts.

8-bit card:

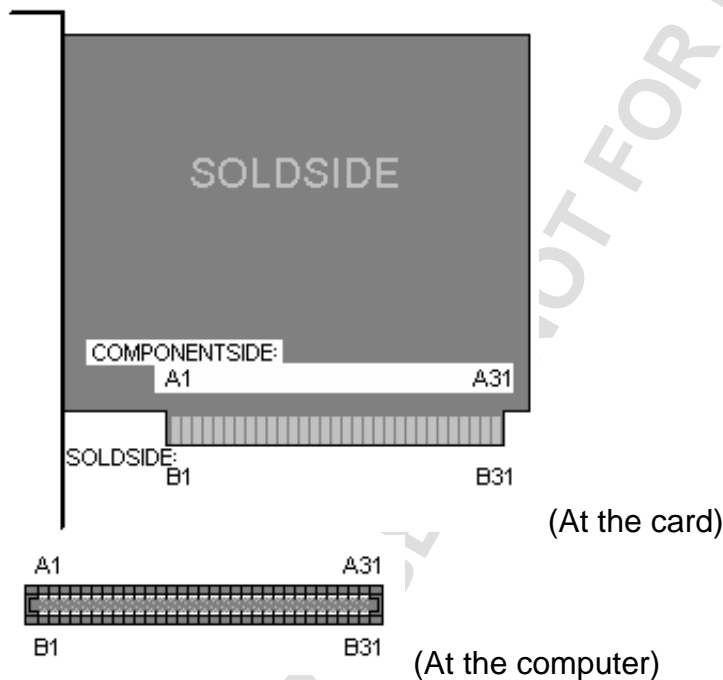

16-bit card:

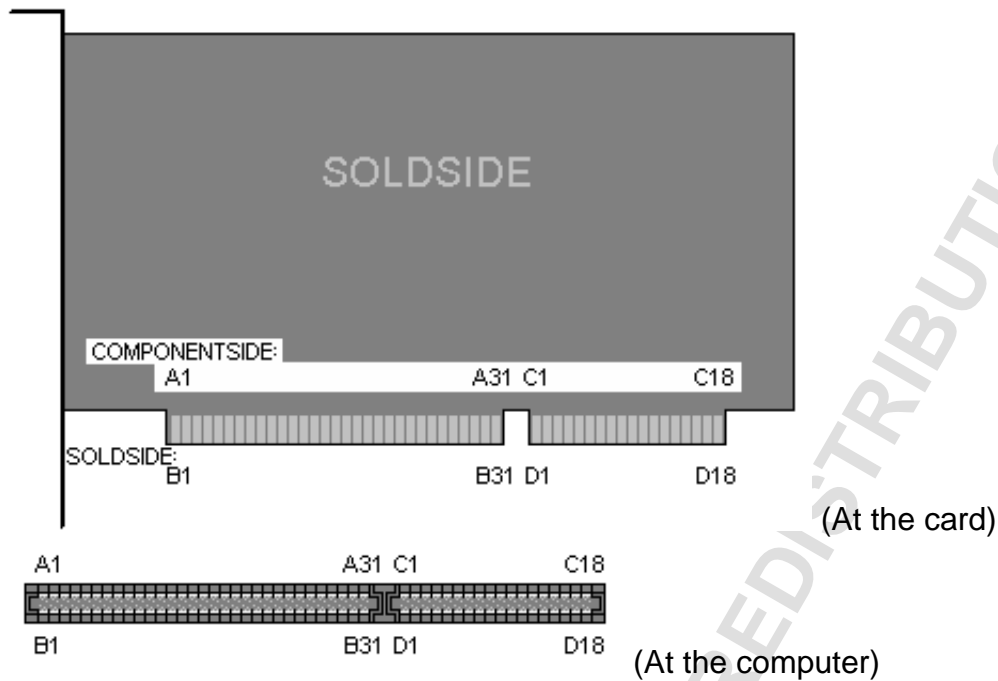

Signal Descriptions:

+5, -5, +12, -12

Power supplies. -5 is often not implemented.

AEN

Address Enable. This is asserted when a DMAC has control of the bus. This prevents an I/O device from responding to the I/O command lines during a DMA transfer. When AEN is active, the DMA Controller has control of the address bus as the memory and I/O read/write command lines.

BALE

Bus Address Latch Enable. The address bus is latched on the rising edge of this signal. The address on the SA bus is valid from the falling edge of BALE to the end of the bus cycle. Memory devices should latch the LA bus on the falling edge of BALE. Some references refer to this signal as Buffered Address Latch Enable, or just Address Latch Enable (ALE). The Buffered-Address Latch Enable is used to latch SA0-19 on the falling edge. This signal is forced high during DMA cycles.

BCLK

Bus Clock, 33% Duty Cycle. Frequency Varies. 4.77 to 8 MHz typical. 8.3 MHz is specified as the maximum, but many systems allow this clock to be set to 12 MHz and higher.

DACK_x

DMA Acknowledge. The active-low DMA Acknowledge 0 to 3 and 5 to 7 are the corresponding acknowledge signals for DRQ 0-3, 5-7.

DRQ_x

DMA Request. These signals are asynchronous channel requests used by I/O channel devices to gain DMA service. DMA request channels 0-3 are for 8-bit data transfer. DMA request channels 5-7 are for 16-bit data transfer. DMA request channel 4 is used internally on the system board. DMA requests should be held high until the corresponding DACK line goes active. DMA requests are serviced in the following priority sequence:
High: DRQ 0, 1, 2, 3, 5, 6, 7 Lowest

BETA RELEASE

IOCS16

I/O size 16. Generated by a 16 bit slave when addressed by a bus master. The active-low I/O Chip Select 16 indicates that the current transfer is a 1 wait state, 16 bit I/O cycle. Open Collector.

I/O CH CK

Channel Check. A low signal generates an NMI. The NMI signal can be masked on a PC, externally to the processor (of course). Bit 7 of port 70(hex) (enable NMI interrupts) and bit 3 of port 61 (hex) (recognition of channel check) must both be set to zero for an NMI to reach the cpu. The I/O Channel Check is an active-low signal which indicates that a parity error exists in a device on the I/O channel.

I/O CH RDY

Channel Ready. Setting this low prevents the default ready timer from timing out. The slave device may then set it high again when it is ready to end the bus cycle. Holding this line low for too long (15 microseconds, typical) can prevent RAM refresh cycles on some systems. This signal is called IOCHRDY (I/O Channel Ready) by some references. CHRDY and NROWS should not be used simultaneously. This may cause problems with some bus controllers. This signal is pulled low by a memory or I/O device to lengthen memory or I/O read/write cycles. It should only be held low for a maximum of 2.5 microseconds.

IOR

The I/O Read is an active-low signal which instructs the I/O device to drive its data onto the data bus, SD0-SD15.

IOW

The I/O Write is an active-low signal which instructs the I/O device to read data from the data bus, SD0-SD15.

IRQ_x

Interrupt Request. IRQ2 has the highest priority. IRQ 10-15 are only available on AT machines, and are higher priority than IRQ 3-7. The Interrupt Request signals which indicate I/O service attention. They are prioritized in the following sequence: Highest IRQ 9(2),10,11,12,14,3,4,5,6,7

LAX_x

Latchable Address lines. Combine with the lower address lines to form a 24 bit address space (16 MB) These unlatched address signals give the system up to 16 MB of address ability. They are valid when "BALE" is high.

MASTER

16 bit bus master. Generated by the ISA bus master when initiating a bus cycle. This active-low signal is used in conjunction with a DRQ line by a processor on the I/O channel to gain control of the system. The I/O processor first issues a DRQ, and upon receiving the corresponding DACK, the I/O processor may assert MASTER, which will allow it to control the system address, data and control lines. This signal should not be asserted for more than 15 microseconds, or system memory may be corrupted due to the lack of memory refresh activity.

MEMCS16

The active-low Memory Chip Select 16 indicates that the current data transfer is a 1 wait state, 16 bit data memory cycle.

MEMR

The Memory Read is an active-low signal which instructs memory devices to drive data onto the data bus SD0-SD15. This signal is active on all memory read cycles.

MEMW

The Memory Write is an active-low signal which instructs memory devices to store data present on the data bus SD0-SD15. This signal is active on all memory write cycles.

NOWS

No Wait State. Used to shorten the number of wait states generated by the default ready timer. This causes the bus cycle to end more quickly, since wait states will not be inserted. Most systems will ignore NOWS if CHRDY is active (low). However, this may cause problems with some bus controllers, and both signals should not be active simultaneously.

OSC

Oscillator, 14.31818 MHz, 50% Duty Cycle. Frequency varies. This was originally divided by 3 to provide the 4.77 MHz cpu clock of early PCs, and divided by 12 to produce the 1.19 MHz system clock. Some references have placed this signal as low as 1 MHz (possibly referencing the system clock), but most modern systems use 14.318 MHz.

This frequency (14.318 MHz) is four times the television colorburst frequency. Refresh timing on many PC's is based on OSC/18, or approximately one refresh cycle every 15 microseconds. Many modern motherboards allow this rate to be changed, which frees up some bus cycles for use by software, but also can cause memory errors if the system RAM cannot handle the slower refresh rates.

REFRESH

Refresh. Generated when the refresh logic is bus master. This active-low signal is used to indicate a memory refresh cycle is in progress. An ISA device acting as bus master may also use this signal to initiate a refresh cycle.

RESET

This signal goes low when the machine is powered up. Driving it low will force a system reset. This signal goes high to reset the system during powerup, low line-voltage or hardware reset. ????????????????

SA0-SA19

System Address Lines, tri-state. The System Address lines run from bit 0 to bit 19. They are latched on to the falling edge of "BALE".

SBHE

System Bus High Enable, tristate. Indicates a 16 bit data transfer. The System Bus High Enable indicates high byte transfer is occurring on the data bus SD8-SD15. This may also indicate an 8 bit transfer using the upper half of the bus data (if an odd address is present).

SD0-SD16

System Data lines, or Standard Data Lines. They are bidirectional and tri-state. On most systems, the data lines float high when not driven. These 16 lines provide for data transfer between the processor, memory and I/O devices.

SMEMR

System Memory Read Command line. Indicates a memory read in the lower 1 MB area. This System Memory Read is an active-low signal which instructs memory devices to drive data onto the data bus SD0-SD15. This signal is active only when the memory address is within the lowest 1MB of memory address space.

SMEMW

System Memory Write Command line. Indicates a memory write in the lower 1 MB area. The System Memory Write is an active-low signal which instructs memory devices to store data preset on the data bus SD0-SD15. This signal is active only when the memory address is within the lowest 1MB of memory address space.

T/C

Terminal Count. Notifies the cpu that that the last DMA data transfer operation is complete. Terminal Count provides a pulse when the terminal count for any DMA channel is reached.

8 Bit Memory or I/O Transfer Timing Diagram (4 wait states shown)

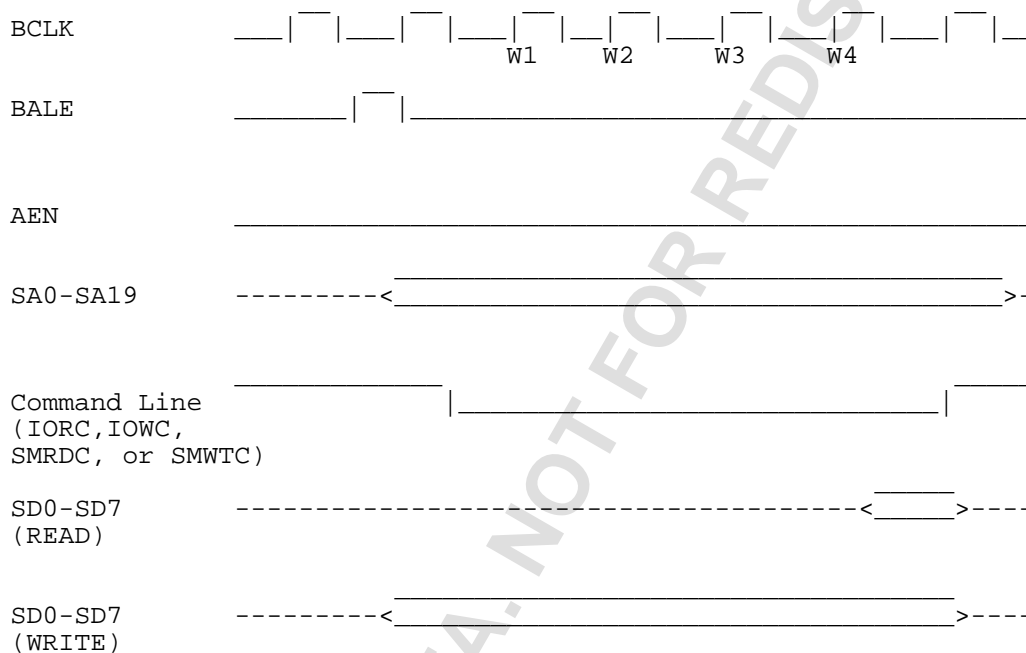

Note: W1 through W4 indicate wait cycles.

BALE is placed high, and the address is latched on the SA bus. The slave device may safely sample the address during the falling edge of BALE, and the address on the SA bus remains valid until the end of the transfer cycle. Note that AEN remains low throughout the entire transfer cycle.

The command line is then pulled low (IORC or IOWC for I/O commands, SMRDSC or SMWTC for memory commands, read and write respectively). For write operations, the data remains on the SD bus for the remainder of the transfer cycle. For read operations, the data must be valid on the falling edge of the last cycle.

NOWS is sampled at the midpoint of each wait cycle. If it is low, the transfer cycle terminates without further wait states. CHRDY is sampled during the first half of the clock cycle. If it is low, further wait cycles will be inserted.

The default for 8 bit transfers is 4 wait states. Some computers allow the number of default wait states to be changed.

16 Bit Memory or I/O Transfer Timing Diagram (1 wait state shown)

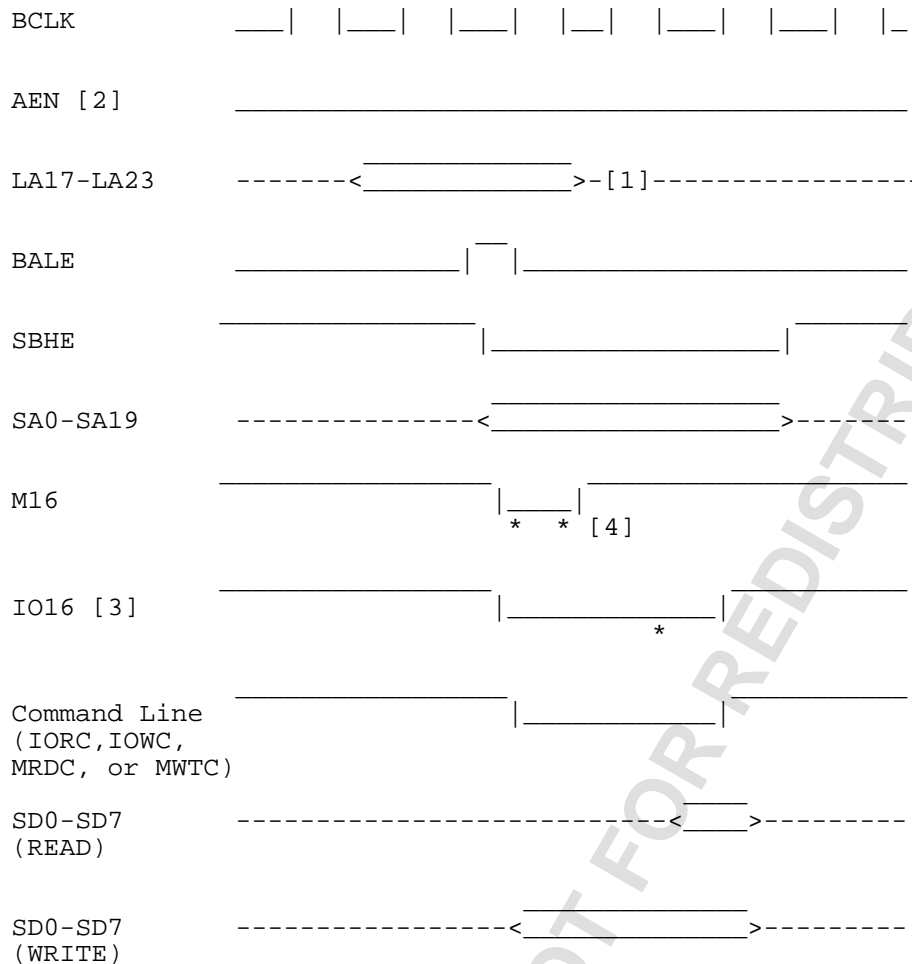

An asterisk (*) denotes the point where the signal is sampled.

[1] The portion of the address on the LA bus for the NEXT cycle may now be placed on the bus. This is used so that cards may begin decoding the address early. Address pipelining must be active.

[2] AEN remains low throughout the entire transfer cycle, indicating that a normal (non-DMA) transfer is occurring.

[3] Some bus controllers sample this signal during the same clock cycle as M16, instead of during the first wait state, as shown above. In this case, IO16 needs to be pulled low as soon as the address is decoded, which is before the I/O command lines are active.

[4] M16 is sampled a second time, in case the adapter card did not active the signal in time for the first sample (usually because the memory device is not monitoring the LA bus for early address information, or is waiting for the falling edge of BALE).

16 bit transfers follow the same basic timing as 8 bit transfers. A valid address may appear on the LA bus prior to the beginning of the transfer cycle. Unlike the SA bus, the LA bus is not latched, and is not valid for the entire transfer cycle (on most computers). The LA bus should be latched on the falling edge of BALE. Note that on some systems, the LA bus signals will follow the same timing as the SA bus. On either type of system, a valid address is present on the falling edge of BALE.

I/O adapter cards do not need to monitor the LA bus or BALE, since I/O addresses are always within the address space of the SA bus.

SBHE will be pulled low by the system board, and the adapter card must respond with IO16 or M16 at the appropriate time, or else the transfer will be split into two separate 8 bit transfers. Many systems expect IO16 or M16 before the command lines are valid. This requires that IO16 or M16 be pulled low as soon as the address is decoded (before it is known whether the cycle is I/O or Memory). If the system is starting a memory cycle, it will ignore IO16 (and vice-versa for I/O cycles and M16).

For read operations, the data is sampled on the rising edge of the last clock cycle. For write operations, valid data appears on the bus before the end of the cycle, as shown in the timing diagram. While the timing diagram indicates that the data needs to be sampled on the rising clock, on most systems it remains valid for the entire clock cycle.

The default for 16 bit transfers is 1 wait state. This may be shortened or lengthened in the same manner as 8 bit transfers, via NOWS and CHRDY. Many systems only allow 16 bit memory devices (and not I/O devices) to transfer using 0 wait states (NOWS has no effect on 16 bit I/O cycles).

SMRDC/SMWTC follow the same timing as MRDC/MWTC respectively when the address is within the lower 1 MB. If the address is not within the lower 1 MB boundary, SMRDC/SMWTC will remain high during the entire cycle.

It is also possible for an 8 bit bus cycle to use the upper portion of the bus. In this case, the timing will be similar to a 16 bit cycle, but an odd address will be present on the bus. This means that the bus is transferring 8 bits using the upper data bits (SD8-SD15).

Shortening or Lengthening the bus cycle:

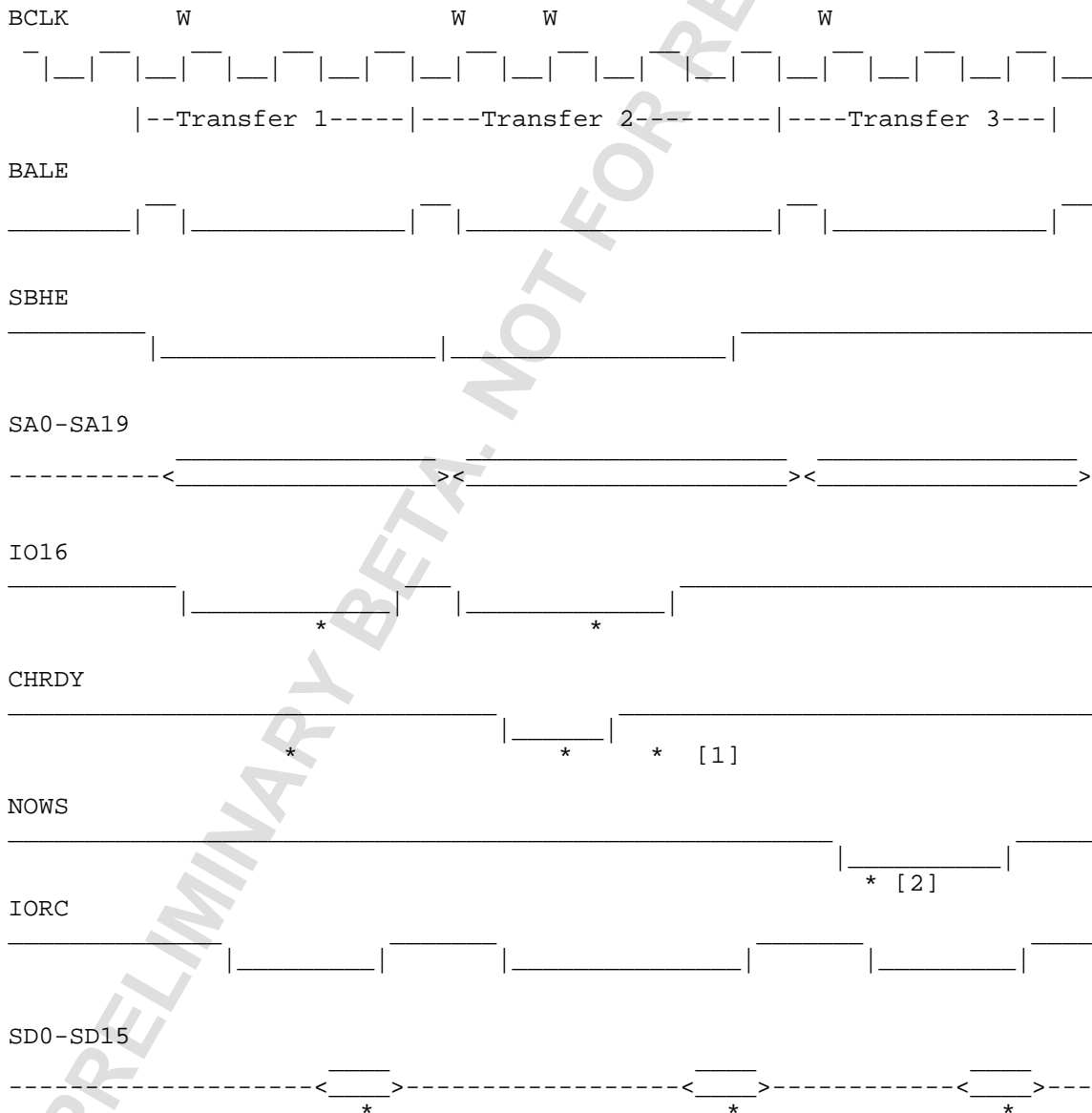

An asterisk (*) denotes the point where the signal is sampled.
W=Wait Cycle

This timing diagram shows three different transfer cycles. The first is a 16 bit standard I/O read. This is followed by an almost identical 16 bit I/O read, with one wait state inserted. The I/O device pulls CHRDY low to indicate that it is not ready to complete the transfer (see [1]). This inserts a wait cycle, and CHRDY is again sampled. At this second sample, the I/O device has completed its operation and released CHRDY, and the bus cycle now terminates. The third cycle is an 8 bit transfer, which is shortened to 1 wait state (the default is 4) by the use of NOWS.

I/O Port Addresses

Note: Only the first 10 address lines are decoded for I/O operations. This limits the I/O address space to address 3FF (hex) and lower. Some systems allow for 16 bit I/O address space, but may be limited due to some I/O cards only decoding 10 of these 16 bits.

Port (hex) Port Assignments

000-00F	DMA Controller
010-01F	DMA Controller (PS/2)
020-02F	Master Programmable Interrupt Controller (PIC)
030-03F	Slave PIC
040-05F	Programmable Interval Timer (PIT)
060-06F	Keyboard Controller
070-071	Real Time Clock
080-083	DMA Page Register
090-097	Programmable Option Select (PS/2)
0A0-0AF	PIC #2
0C0-0CF	DMAC #2
0E0-0EF	reserved
0F0-0FF	Math coprocessor, PCJr Disk Controller
100-10F	Programmable Option Select (PS/2)
110-16F	AVAILABLE
170-17F	Hard Drive 1 (AT)
180-1EF	AVAILABLE
1F0-1FF	Hard Drive 0 (AT)
200-20F	Game Adapter
210-217	Expansion Card Ports
220-26F	AVAILABLE
278-27F	Parallel Port 3
280-2A1	AVAILABLE
2A2-2A3	clock
2B0-2DF	EGA/Video
2E2-2E3	Data Acquisition Adapter (AT)
2E8-2EF	Serial Port COM4
2F0-2F7	Reserved
2F8-2FF	Serial Port COM2
300-31F	Prototype Adapter, Periscope Hardware Debugger
320-32F	AVAILABLE
330-33F	Reserved for XT/370
340-35F	AVAILABLE
360-36F	Network
370-377	Floppy Disk Controller
378-37F	Parallel Port 2
380-38F	SDLC Adapter
390-39F	Cluster Adapter
3A0-3AF	reserved
3B0-3BF	Monochrome Adapter
3BC-3BF	Parallel Port 1
3C0-3CF	EGA/VGA
3D0-3DF	Color Graphics Adapter
3E0-3EF	Serial Port COM3
3F0-3F7	Floppy Disk Controller

3F8-3FF Serial Port COM1

Soundblaster cards usually use I/O ports 220-22F.
Data acquisition cards frequently use 300-31F.

DMA Read and Write

The ISA bus uses two DMA controllers (DMAC) cascaded together. The slave DMAC connects to the master DMAC via DMA channel 4 (channel 0 on the master DMAC). The slave therefore gains control of the bus through the master DMAC. On the ISA bus, the DMAC is programmed to use fixed priority (channel 0 always has the highest priority), which means that channel 0-4 from the slave have the highest priority (since they connect to the master channel 0), followed by channels 5-7 (which are channel 1-3 on the master).

The DMAC can be programmed for read transfers (data is read from memory and written to the I/O device), write transfers (data is read from the I/O device and written to memory), or verify transfers (neither a read or a write - this was used by DMA CH0 for DRAM refresh on early PCs).

Before a DMA transfer can take place, the DMA Controller (DMAC) must be programmed. This is done by writing the start address and the number of bytes to transfer (called the transfer count) and the direction of the transfer to the DMAC. After the DMAC has been programmed, the device may activate the appropriate DMA request (DRQx) line.

Slave DMA Controller

I/O Port

- 0000 DMA CH0 Memory Address Register
Contains the lower 16 bits of the memory address, written as two consecutive bytes.
- 0001 DMA CH0 Transfer Count
Contains the lower 16 bits of the transfer count, written as two consecutive bytes.
- 0002 DMA CH1 Memory Address Register
- 0003 DMA CH1 Transfer Count
- 0004 DMA CH2 Memory Address Register
- 0005 DMA CH2 Transfer Count
- 0006 DMA CH3 Memory Address Register
- 0007 DMA CH3 Transfer Count
- 0008 DMAC Status/Control Register
Status (I/O read) bits 0-3: Terminal Count, CH 0-3
- bits 4-7: Request CH0-3
Control (write)
- bit 0: Mem to mem enable (1 = enabled)
- bit 1: ch0 address hold enable (1 = enabled)
- bit 2: controller disable (1 = disabled)
- bit 3: timing (0 = normal, 1 = compressed)
- bit 4: priority (0 = fixed, 1 = rotating)
- bit 5: write selection (0 = late, 1 = extended)
- bit 6: DRQx sense asserted (0 = high, 1 = low)
- bit 7: DAKn sense asserted (0 = low, 1 = high)
- 0009 Software DRQn Request
- bits 0-1: channel select (CH0-3)
- bit 2: request bit (0 = reset, 1 = set)
- 000A DMA mask register
- bits 0-1: channel select (CH0-3)
- bit 2: mask bit (0 = reset, 1 = set)
- 000B DMA Mode Register
- bits 0-1: channel select (CH0-3)
- bits 2-3: 00 = verify transfer, 01 = write transfer, 10 = read transfer, 11 = reserved
- bit 4: Auto init (0 = disabled, 1 = enabled)
- bit 5: Address (0 = increment, 1 = decrement)
- bits 6-7: 00 = demand transfer mode, 01 = single transfer mode, 10 = block transfer mode, 11 = cascade mode

BETA RELEASE

- 000C DMA Clear Byte Pointer
Writing to this causes the DMAC to clear the pointer used to keep track of 16 bit data transfers into and out of the DMAC for hi/low byte sequencing.
- 000D DMA Master Clear (Hardware Reset)
- 000E DMA Reset Mask Register - clears the mask register
- 000F DMA Mask Register
- bits 0-3: mask bits for CH0-3 (0 = not masked, 1 = masked)
- 0081 DMA CH2 Page Register (address bits A16-A23)
- 0082 DMA CH3 Page Register
- 0083 DMA CH1 Page Register
- 0087 DMA CH0 Page Register
- 0089 DMA CH6 Page Register
- 008A DMA CH7 Page Register
- 008B DMA CH5 Page Register

Master DMA Controller

I/O Port

- 00C0 DMA CH4 Memory Address Register
Contains the lower 16 bits of the memory address, written as two consecutive bytes.
- 00C2 DMA CH4 Transfer Count
Contains the lower 16 bits of the transfer count, written as two consecutive bytes.
- 00C4 DMA CH5 Memory Address Register
- 00C6 DMA CH5 Transfer Count
- 00C8 DMA CH6 Memory Address Register
- 00CA DMA CH6 Transfer Count
- 00CC DMA CH7 Memory Address Register
- 00CE DMA CH7 Transfer Count
- 00D0 DMAC Status/Control Register
Status (I/O read) bits 0-3: Terminal Count, CH 4-7
- bits 4-7: Request CH4-7
Control (write)- bit 0: Mem to mem enable (1 = enabled)
- bit 1: ch0 address hold enable (1 = enabled)
- bit 2: controller disable (1 = disabled)
- bit 3: timing (0 = normal, 1 = compressed)
- bit 4: priority (0 = fixed, 1 = rotating)
- bit 5: write selection (0 = late, 1 = extended)
- bit 6: DRQx sense asserted (0 = high, 1 = low)
- bit 7: DAKn sense asserted (0 = low, 1 = high)
- 00D2 Software DRQn Request
- bits 0-1: channel select (CH4-7)
- bit 2: request bit (0 = reset, 1 = set)
- 00D4 DMA mask register
- bits 0-1: channel select (CH4-7)
- bit 2: mask bit (0 = reset, 1 = set)
- 00D6 DMA Mode Register
- bits 0-1: channel select (CH4-7)
- bits 2-3: 00 = verify transfer, 01 = write transfer, 10 = read transfer, 11 = reserved
- bit 4: Auto init (0 = disabled, 1 = enabled)
- bit 5: Address (0 = increment, 1 = decrement)
- bits 6-7: 00 = demand transfer mode, 01 = single transfer mode, 10 = block transfer mode, 11 = cascade mode
- 00D8 DMA Clear Byte Pointer
Writing to this causes the DMAC to clear the pointer used to keep track of 16 bit data transfers into and out of the DMAC for hi/low byte sequencing.
- 00DA DMA Master Clear (Hardware Reset)
- 00DC DMA Reset Mask Register - clears the mask register
- 00DE DMA Mask Register
- bits 0-3: mask bits for CH4-7 (0 = not masked, 1 = masked)

Single Transfer Mode

The DMAC is programmed for transfer. The DMA device requests a transfer by driving the appropriate DRQ line high. The DMAC responds by asserting AEN and acknowledges the DMA request through the appropriate DAK line. The I/O and memory command lines are also asserted. When the DMA device sees the DAK signal, it drops the DRQ line.

The DMAC places the memory address on the SA bus (at the same time as the command lines are asserted), and the device either reads from or writes to memory, depending on the type of transfer. The transfer count is incremented, and the address incremented/decremented. DAK is de-asserted. The cpu now once again has control of the bus, and continues execution until the I/O device is once again ready for transfer. The DMA device repeats the procedure, driving DRQ high and waiting for DAK, then transferring data. This continues for a number of cycles equal to the transfer count. When this has been completed, the DMAC signals the cpu that the DMA transfer is complete via the TC (terminal count) signal.

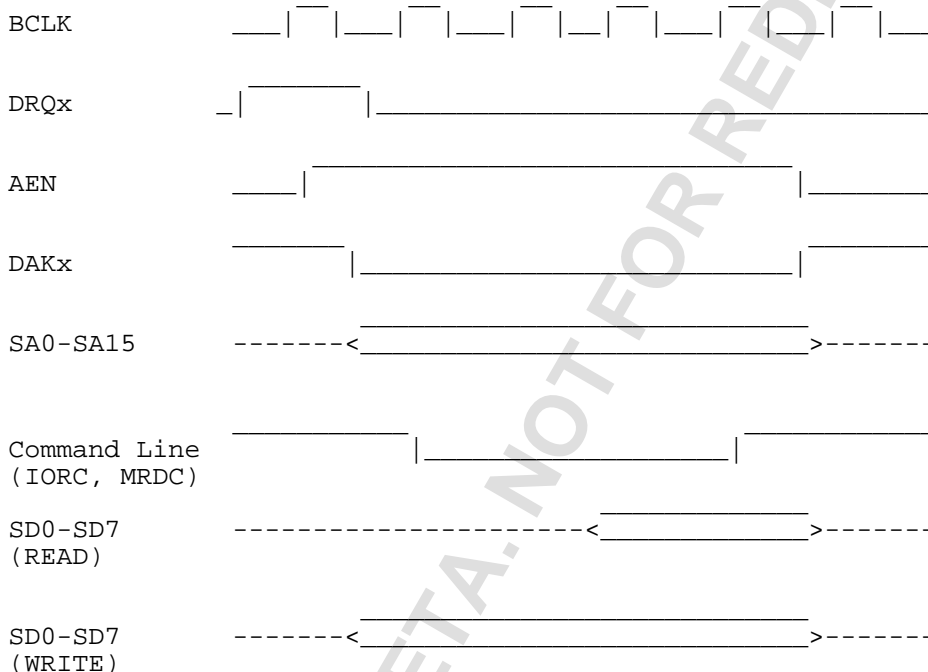

Block Transfer Mode

The DMAC is programmed for transfer. The device attempting DMA transfer drives the appropriate DRQ line high. The motherboard responds by driving AEN high and DAK low. This indicates that the DMA device is now the bus master. In response to the DAK signal, the DMA device drops DRQ. The DMAC places the address for DMA transfer on the address bus. Both the memory and I/O command lines are asserted (since DMA involves both an I/O and a memory device). AEN prevents I/O devices from responding to the I/O command lines, which would not result in proper operation since the I/O lines are active, but a memory address is on the address bus. The data transfer is now done (memory read or write), and the DMAC increments/decrements the address and begins another cycle. This continues for a number of cycles equal to the DMAC transfer count. When this has been completed, the terminal count signal (TC) is generated by the DMAC to inform the cpu that the DMA transfer has been completed.

Note: Block transfer must be used carefully. The bus cannot be used for other things (like RAM refresh) while block mode transfers are being done.

Demand Transfer Mode

The DMAC is programmed for transfer. The device attempting DMA transfer drives the appropriate DRQ line high. The motherboard responds by driving AEN high and DAK low. This indicates that the DMA device is now the bus master. Unlike single transfer and block transfer, the DMA device does not drop DRQ in response to DAK. The DMA device transfers data in the same manner as for block transfers. The DMAC will continue to generate DMA cycles as long as the I/O device asserts DRQ. When the I/O device is unable to continue the transfer (if it no longer had data ready to transfer, for example), it drops DRQ and the cpu once again has control of the bus. Control is returned to the DMAC by once again asserting DRQ. This continues until the terminal count has been reached, and the TC signal informs the cpu that the transfer has been completed.

Interrupts on the ISA bus

Name	Interrupt	Description
NMI	2	Parity Error, Mem Refresh
IRQ0	8	8253 Channel 0 (System Timer)
IRQ1	9	Keyboard
IRQ2	A	Cascade from slave PIC
IRQ3	B	COM2
IRQ4	C	COM1
IRQ5	D	LPT2
IRQ6	E	Floppy Drive Controller
IRQ7	F	LPT1
IRQ8	F	Real Time Clock
IRQ9	F	Redirection to IRQ2
IRQ10	F	Reserved
IRQ11	F	Reserved
IRQ12	F	Mouse Interface
IRQ13	F	Coprocessor
IRQ14	F	Hard Drive Controller
IRQ15	F	Reserved

IRQ0,1,2,8, and 13 are not available on the ISA bus.

The IBM PC and XT had only a single 8259 interrupt controller. The AT and later machines have a second interrupt controller, and the two are used in a master/slave combination. IRQ2 and IRQ9 are the same pin on most ISA systems. Interrupts on most systems may be either edge triggered or level triggered. The default is usually edge triggered, and active high (low to high transition). The interrupt level must be held high until the first interrupt acknowledge cycle (two interrupt acknowledge bus cycles are generated in response to an interrupt request).

The software aspects of interrupts and interrupt handlers is intentionally omitted from this document, due to the numerous syntactical differences in software tools and the fact that adequate documentation of this topic is usually provided with development software.

Bus Mastering:

An ISA device may take control of the bus, but this must be done with caution. There are no safety mechanisms involved, and so it is easily possible to crash the entire system by incorrectly taking control of the bus. For example, most systems require bus cycles for DRAM refresh. If the ISA bus master does not relinquish control of the bus or generate its own DRAM refresh cycles every 15 microseconds, the system RAM can become corrupted. The ISA adapter card can generate refresh cycles without relinquishing control of the bus by asserting REFRESH. MRDC can be then monitored to determine when the refresh cycle ends.

To take control of the bus, the device first asserts its DRQ line. The DMAC sends a hold request to the cpu, and when the DMAC receives a hold acknowledge, it asserts the appropriate DAK line corresponding to the DRQ line asserted. The device is now the bus master. AEN is asserted, so if the device wishes to access I/O devices, it must assert MASTER16 to release AEN. Control of the bus is returned to the system board by releasing

DRQ.

Contributor: Joakim Ögren <qtech@mailhost.net>, Niklas Edmundsson <nikke@ing.umu.se>, Mark Sokos <msokos1@gl.umbc.edu>, Pieter Hollants <fxmts205@rz.uni-frankfurt.de>

Sources: Mark Sokos ISA page <<http://www.gl.umbc.edu/~msokos1/isa.txt>>

Sources: "ISA System Architecture, 3rd Edition" by Tom Shanley and Don Anderson ISBN 0-201-40996-8

Sources: "Eisa System Architecture, 2nd Edition" by Tom Shanley and Don Anderson ISBN 0-201-40995-X

Sources: "Microcomputer Busses" by R.M. Cram ISBN 0-12-196155-9

Sources: HelpPC v2.10 Quick Reference Utility, by David Jurgens

Sources: ZIDA 80486 Mother Board User's Manual, OPTi 486, 82C495sx

Please send any comments to Joakim Ögren <qtech@mailhost.net>.

PRELIMINARY BETA. NOT FOR REDISTRIBUTION

EISA

EISA=Extended Industry Standard Architecture.
Developed by Compaq, AST, Zenith, Tandy...

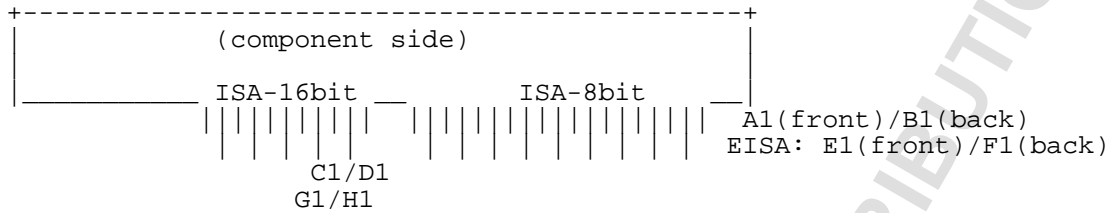

A, C, E, G=Component Side
A, B, F, H=Sold Side

**NOT
DRAWN
YET...**

(At the computer)

62+38 PIN EDGE CONNECTOR at the computer.

Pin	Name	Description
E1	CMD#	Command Phase
E2	START#	Start Phase
E3	EXRDY	EISA Ready
E4	EX32#	EISA Slave Size 32
E5	GND	Ground
E6	KEY	Access Key
E7	EX16#	EISA Slave Size 16
E8	SLBURST#	Slave Burst
E9	MSBURST#	Master Burst
E10	W/R#	Write/Read
E11	GND	Ground
E12	RES	Reserved
E13	RES	Reserved
E14	RES	Reserved
E15	GND	Ground
E16	KEY	Access Key
E17	BE1#	Byte Enable 1
E18	LA31#	Latchable Addressline 31
E19	GND	Ground
E20	LA30#	Latchable Addressline 30
E21	LA28#	Latchable Addressline 28
E22	LA27#	Latchable Addressline 27
E23	LA25#	Latchable Addressline 25
E24	GND	Ground
E25	KEY	Access Key
E26	LA15	Latchable Addressline 15
E27	LA13	Latchable Addressline 13
E28	LA12	Latchable Addressline 12
E29	LA11	Latchable Addressline 11
E30	GND	Ground
E31	LA9	Latchable Addressline 9
F1	GND	Ground
F2	+5V	+5 VDC
F3	+5V	+5 VDC
F4	---	---
F5	---	---

BETA RELEASE

F6	KEY	Access Key
F7	---	
F8	---	
F9	+12V	+12 VDC
F10	M/IO#	Memory/Input-Output
F11	LOCK#	Lock bus
F12	RES	Reserved
F13	GND	Ground
F14	RES	Reserved
F15	BE3#	Byte Enable 3
F16	KEY	Access Key
F17	BE2#	Byte Enable 2
F18	BE0#	Byte Enable 0
F19	GND	Ground
F20	+5V	+5 VDC
F21	LA29#	Latchable Addressline 29
F22	GND	Ground
F23	LA26#	Latchable Addressline 26
F24	LA24#	Latchable Addressline 24
F25	KEY	Access Key
F26	LA16	Latchable Addressline 16
F27	LA14	Latchable Addressline 14
F28	+5V	+5 VDC
F29	+5V	+5 VDC
F30	GND	Ground
F31	LA10	Latchable Addressline 10
G1	LA7	Latchable Addressline 7
G2	GND	Ground
G3	LA4	Latchable Addressline 4
G4	LA3	Latchable Addressline 3
G5	GND	Ground
G6	KEY	Access Key
G7	D17	Data 17
G8	D19	Data 19
G9	D20	Data 20
G10	D22	Data 22
G11	GND	Ground
G12	D25	Data 25
G13	D26	Data 26
G14	D28	Data 28
G15	KEY	Access Key
G16	GND	Ground
G17	D30	Data 30
G18	D31	Data 31
G19	MREQx	Master Request
H1	LA8	Latchable Addressline 8
H2	LA6	Latchable Addressline 6
H3	LA5	Latchable Addressline 5
H4	+5V	+5 VDC
H5	LA2	Latchable Addressline 2
H6	KEY	Access Key
H7	D16	Data 16
H8	D18	Data 18
H9	GND	Ground
H10	D21	Data 21
H11	D23	Data 23
H12	D24	Data 24
H13	GND	Ground

BETA RELEASE

H14	D27	Data 27
H15	KEY	Access Key
H16	D29	Data 29
H17	+5V	+5 VDC
H18	+5V	+5 VDC
H19	MAKx	Master Acknowledge

Contributor: Joakim Ögren <qtech@mailhost.net>, Mark Sokos <msokos1@gl.umbc.edu>

Sources: Mark Sokos EISA page <<http://www.gl.umbc.edu/~msokos1/eisa.txt>>

Sources: "Eisa System Architecture, 2nd Edition" by Tom Shanley and Don Anderson, ISBN 0-201-40995-X

Sources: comp.sys.ibm.pc.hardware.* FAQ Part 4

<<ftp://rtfm.mit.edu/pub/usenet/news.answers/pc-hardware-faq/part1>>, maintained by Ralph Valentino <ralf@alum.wpi.edu>

Please send any comments to Joakim Ögren <qtech@mailhost.net>.

PRELIMINARY BETA. NOT FOR REDISTRIBUTION.

EISA (Technical)

This section is currently based solely on the work by Mark Sokos.

This file is intended to provide a basic functional overview of the EISA Bus, so that hobbyists and amateurs can design their own EISA compatible cards.

It is not intended to provide complete coverage of the EISA standard.

EISA is an acronym for Extended Industry Standard Architecture. It is an extension of the ISA architecture, which is a standardized version of the bus originally developed by IBM for their PC computers. EISA is upwardly compatible, which means that cards originally designed for the 8 bit IBM bus (often referred to as the XT bus) and cards designed for the 16 bit bus (referred to as the AT bus, and also as the ISA bus), will work in an EISA slot. EISA specific cards will not work in an AT or an XT slot.

The EISA connector uses multiple rows of connectors. The upper row is the same as a regular ISA slot, and the lower row contains the EISA extension. The slot is keyed so that ISA cards cannot be inserted to the point where they connect with the EISA signals.

Signal Descriptions

+5, -5, +12, -12

Power supplies. -5 is often not implemented.

AEN

Address Enable. This is asserted when a DMAC has control of the bus. This prevents an I/O device from responding to the I/O command lines during a DMA transfer.

BALE

Bus Address Latch Enable. The address bus is latched on the rising edge of this signal. The address on the SA bus is valid from the falling edge of BALE to the end of the bus cycle. Memory devices should latch the LA bus on the falling edge of BALE.

BCLK

Bus Clock, 33% Duty Cycle. Frequency Varies. 8.33 MHz is specified as the maximum, but many systems allow this clock to be set to 10 MHz and higher.

BE(x)

Byte Enable. Indicates to the slave device which bytes on the data bus contain valid data. A 16 bit transfer would assert BE0 and BE1, for example, but not BE2 or BE3.

CHCHK

Channel Check. A low signal generates an NMI. The NMI signal can be masked on a PC, externally to the processor (of course). Bit 7 of port 70(hex) (enable NMI interrupts) and bit 3 of port 61 (hex) (recognition of channel check) must both be set to zero for an NMI to reach the cpu.

CHRDY

Channel Ready. Setting this low prevents the default ready timer from timing out. The slave device may then set it high again when it is ready to end the bus cycle. Holding this line low for too long can cause problems on some systems. CHRDY and NWS should not be used simultaneously. This may cause problems with some bus controllers.

CMD

Command Phase. This signal indicates that the current bus cycle is in the command phase. After the start phase (see START), the data is transferred during the CMD phase. CMD remains asserted from the falling edge of START until the end of the bus cycle.

SD0-SD16

System Data lines. They are bidirectional and tri-state.

DAK_x

DMA Acknowledge.

DRQ_x

DMA Request.

EX16

EISA Slave Size 16. This is used by the slave device to inform the bus master that it is capable of 16 bit transfers.

EX32

EISA Slave Size 32. This is used by the slave device to inform the bus master that it is capable of 32 bit transfers.

EXRDY

EISA Ready. If this signal is asserted, the cycle will end on the next rising edge of BCLK. The slave device drives this signal low to insert wait states.

IO16

I/O size 16. Generated by a 16 bit slave when addressed by a bus master.

IORC

I/O Read Command line.

IOWC

I/O Write Command line.

IRQ_x

Interrupt Request. IRQ2 has the highest priority.

LAX_x

Latchable Address lines.

LOCK

Asserting this signal prevents other bus masters from requesting control of the bus.

MAK_x

Master Acknowledge for slot x: Indicates that the bus master request (MREQ_x) has been granted.

MASTER16

16 bit bus master. Generated by the ISA bus master when initiating a bus cycle.

M/IO

Memory/Input-Output. This is used to indicate whether the current bus cycle is a memory or an I/O operation.

M16

Memory Access, 16 bit

MRDC

Memory Read Command line.

MREQ_x

Master Request for Slot x: This is a slot specific request for the device to become the bus master.

MSBURST

Master Burst. The bus master asserts this signal in response to SLBURST. This tells the slave device that the bus master is also capable of burst cycles.

MWTC

Memory Write Command line.

NOWS

No Wait State. Used to shorten the number of wait states generated by the default ready timer. This causes the bus cycle to end more quickly, since wait states will not be inserted. Most systems will ignore NOWS if CHRDY is active (low). However, this may cause problems with some bus controllers, and both signals should not be active simultaneously.

OSC

Oscillator, 14.318 MHz, 50% Duty Cycle. Frequency varies.

REFRESH

Refresh. Generated when the refresh logic is bus master.

RESDRV

This signal goes low when the machine is powered up. Driving it low will force a system reset.

SA0-SA19

System Address Lines, tri-state.

SBHE

System Bus High Enable, tristate. Indicates a 16 bit data transfer.

SLBURST

Slave Burst. The slave device uses this to indicate that it is capable of burst cycles. The bus master will respond with MSBURST if it is also capable of burst cycles.

SMRDC

Standard Memory Read Command line. Indicates a memory read in the lower 1 MB area.

SMWTC

Standard Memory Write Command line. Indicates a memory write in the lower 1 MB area.

START

Start Phase. This signal is low when the current bus cycle is in the start phase. Address and M/IO signals are decoded during this phase. Data is transferred during the command phase (indicated by CMD).

TC

Terminal Count. Notifies the cpu that that the last DMA data transfer operation is complete.

W/R

Write or Read. Used to indicate if the current bus cycle is a read or a write operation.

Contributor: Joakim Ögren <qtech@mailhost.net>, Mark Sokos <msokos1@gl.umbc.edu>

Sources: Mark Sokos EISA page <<http://www.gl.umbc.edu/~msokos1/eisa.txt>>

Sources: "Eisa System Architecture, 2nd Edition" by Tom Shanley and Don Anderson, ISBN 0-201-40995-X

Please send any comments to Joakim Ögren <qtech@mailhost.net>.

PCI

PCI=Peripheral Component Interconnect

PCI Universal Card 32/64 bit

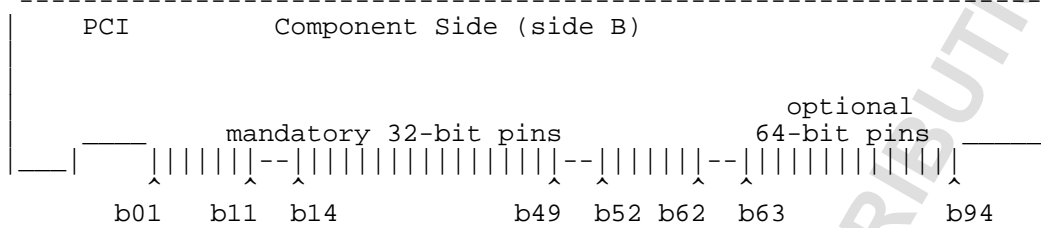

PCI 5V Card 32/64 bit

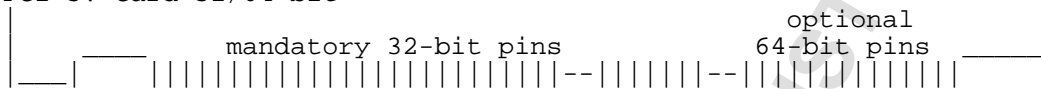

PCI 3.3V Card 32/64 bit

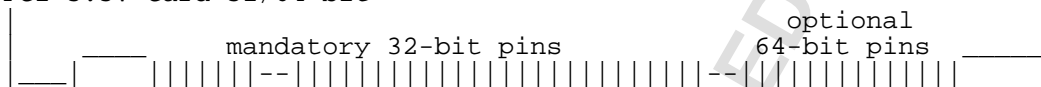

**NOT
DRAWN
YET...**

(At the computer)

98+22 PIN EDGE CONNECTOR at the computer.

Pin	+5V	+3.3V	Universal	Description
A1	TRST			Test Logic Reset
A2	+12V			+12 VDC
A3	TMS			Test Mde Select
A4	TDI			Test Data Input
A5	+5V			+5 VDC
A6	INTA			Interrupt A
A7	INTC			Interrupt C
A8	+5V			+5 VDC
A9	RESV01			Reserved VDC
A10	+5V	+3.3V	Signal Rail	+V I/O (+5 V or +3.3 V)
A11	RESV03			Reserved VDC
A12	GND03	(OPEN)	(OPEN)	Ground or Open (Key)
A13	GND05	(OPEN)	(OPEN)	Ground or Open (Key)
A14	RESV05			Reserved VDC
A15	RESET			Reset
A16	+5V	+3.3V	Signal Rail	+V I/O (+5 V or +3.3 V)
A17	GNT			Grant PCI use
A18	GND08			Ground
A19	RESV06			Reserved VDC
A20	AD30			Address/Data 30
A21	+3.3V01			+3.3 VDC
A22	AD28			Address/Data 28
A23	AD26			Address/Data 26
A24	GND10			Ground
A25	AD24			Address/Data 24
A26	IDSEL			Initialization Device Select
A27	+3.3V03			+3.3 VDC
A28	AD22			Address/Data 22
A29	AD20			Address/Data 20
A30	GND12			Ground
A31	AD18			Address/Data 18

BETA RELEASE

A32	AD16			Address/Data 16
A33	+3.3V05			+3.3 VDC
A34	FRAME			Address or Data phase
A35	GND14			Ground
A36	TRDY			Target Ready
A37	GND15			Ground
A38	STOP			Stop Transfer Cycle
A39	+3.3V07			+3.3 VDC
A40	SDONE			Snoop Done
A41	SBO			Snoop Backoff
A42	GND17			Ground
A43	PAR			Parity
A44	AD15			Address/Data 15
A45	+3.3V10			+3.3 VDC
A46	AD13			Address/Data 13
A47	AD11			Address/Data 11
A48	GND19			Ground
A49	AD9			Address/Data 9
A52	C/BE0			Command, Byte Enable 0
A53	+3.3V11			+3.3 VDC
A54	AD6			Address/Data 6
A55	AD4			Address/Data 4
A56	GND21			Ground
A57	AD2			Address/Data 2
A58	AD0			Address/Data 0
A59	+5V	+3.3V	Signal Rail	+V I/O (+5 V or +3.3 V)
A60	REQ64			Request 64 bit ???
A61	VCC11			+5 VDC
A62	VCC13			+5 VDC
A63	GND			Ground
A64	C/BE[7]#			Command, Byte Enable 7
A65	C/BE[5]#			Command, Byte Enable 5
A66	+5V	+3.3V	Signal Rail	+V I/O (+5 V or +3.3 V)
A67	PAR64			Parity 64 ???
A68	AD62			Address/Data 62
A69	GND			Ground
A70	AD60			Address/Data 60
A71	AD58			Address/Data 58
A72	GND			Ground
A73	AD56			Address/Data 56
A74	AD54			Address/Data 54
A75	+5V	+3.3V	Signal Rail	+V I/O (+5 V or +3.3 V)
A76	AD52			Address/Data 52
A77	AD50			Address/Data 50
A78	GND			Ground
A79	AD48			Address/Data 48
A80	AD46			Address/Data 46
A81	GND			Ground
A82	AD44			Address/Data 44
A83	AD42			Address/Data 42
A84	+5V	+3.3V	Signal Rail	+V I/O (+5 V or +3.3 V)
A85	AD40			Address/Data 40
A86	AD38			Address/Data 38
A87	GND			Ground
A88	AD36			Address/Data 36
A89	AD34			Address/Data 34
A90	GND			Ground
A91	AD32			Address/Data 32
A92	RES			Reserved

A93	GND			Ground
A94	RES			Reserved
B1	-12V			-12 VDC
B2	TCK			Test Clock
B3	GND			Ground
B4	TDO			Test Data Output
B5	+5V			+5 VDC
B6	+5V			+5 VDC
B7	INTB			Interrupt B
B8	INTD			Interrupt D
B9	PRSNT1			Reserved
B10	RES			+V I/O (+5 V or +3.3 V)
B11	PRSNT2			??
B12	GND	(OPEN)	(OPEN)	Ground or Open (Key)
B13	GND	(OPEN)	(OPEN)	Ground or Open (Key)
B14	RES			Reserved VDC
B15	GND			Reset
B16	CLK			Clock
B17	GND			Ground
B18	REQ			Request
B19	+5V	+3.3V	Signal Rail	+V I/O (+5 V or +3.3 V)
B20	AD31			Address/Data 31
B21	AD29			Address/Data 29
B22	GND			Ground
B23	AD27			Address/Data 27
B24	AD25			Address/Data 25
B25	+3.3V			+3.3VDC
B26	C/BE3			Command, Byte Enable 3
B27	AD23			Address/Data 23
B28	GND			Ground
B29	AD21			Address/Data 21
B30	AD19			Address/Data 19
B31	+3.3V			+3.3 VDC
B32	AD17			Address/Data 17
B33	C/BE2			Command, Byte Enable 2
B34	GND13			Ground
B35	IRDY			Initiator Ready
B36	+3.3V06			+3.3 VDC
B37	DEVSEL			Device Select
B38	GND16			Ground
B39	LOCK			Lock bus
B40	PERR			Parity Error
B41	+3.3V08			+3.3 VDC
B42	SERR			System Error
B43	+3.3V09			+3.3 VDC
B44	C/BE1			Command, Byte Enable 1
B45	AD14			Address/Data 14
B46	GND18			Ground
B47	AD12			Address/Data 12
B48	AD10			Address/Data 10
B49	GND20			Ground
B50	(OPEN)	GND	(OPEN)	Ground or Open (Key)
B51	(OPEN)	GND	(OPEN)	Ground or Open (Key)
B52	AD8			Address/Data 8
B53	AD7			Address/Data 7
B54	+3.3V12			+3.3 VDC
B55	AD5			Address/Data 5
B56	AD3			Address/Data 3
B57	GND22			Ground

BETA RELEASE

B58	AD1		Address/Data 1
B59	VCC08		+5 VDC
B60	ACK64		Acknowledge 64 bit ???
B61	VCC10		+5 VDC
B62	VCC12		+5 VDC
B63	RES		Reserved
B64	GND		Ground
B65	C/BE[6]#		Command, Byte Enable 6
B66	C/BE[4]#		Command, Byte Enable 4
B67	GND		Ground
B68	AD63		Address/Data 63
B69	AD61		Address/Data 61
B70	+5V	+3.3V	Signal Rail +V I/O (+5 V or +3.3 V)
B71	AD59		Address/Data 59
B72	AD57		Address/Data 57
B73	GND		Ground
B74	AD55		Address/Data 55
B75	AD53		Address/Data 53
B76	GND		Ground
B77	AD51		Address/Data 51
B78	AD49		Address/Data 49
B79	+5V	+3.3V	Signal Rail +V I/O (+5 V or +3.3 V)
B80	AD47		Address/Data 47
B81	AD45		Address/Data 45
B82	GND		Ground
B83	AD43		Address/Data 43
B84	AD41		Address/Data 41
B85	GND		Ground
B86	AD39		Address/Data 39
B87	AD37		Address/Data 37
B88	+5V	+3.3V	Signal Rail +V I/O (+5 V or +3.3 V)
B89	AD35		Address/Data 35
B90	AD33		Address/Data 33
B91	GND		Ground
B92	RES		Reserved
B93	RES		Reserved
B94	GND		Ground

Notes: Pin 63-94 exists only on 64 bit PCI implementations.

+V I/O is 3.3V on 3.3V boards, 5V on 5V boards, and define signal rails on the Universal board.

Contributor: Joakim Ögren <qtech@mailhost.net>, Phil Toms <ptoms@m4.com>

Source: ?

Please send any comments to Joakim Ögren <qtech@mailhost.net>.

PCI (Technical)

This section is currently based solely on the work by Mark Sokos.

This file is not intended to be a thorough coverage of the PCI standard. It is for informational purposes only, and is intended to give designers and hobbyists an overview of the bus so that they might be able to design their own PCI cards. Thus, I/O operations are explained in the most detail, while memory operations, which will usually not be dealt with by an I/O card, are only briefly explained. Hobbyists are also warned that, due to the higher clock speeds involved, PCI cards are more difficult to design than ISA cards or cards for other slower buses. Many companies are now making PCI prototyping cards, and, for those fortunate enough to have access to FPGA programmers, companies like Xilinx are offering PCI compliant designs which you can use as a starting point for your own projects.

For a copy of the full PCI standard, contact:

PCI Special Interest Group (SIG)
PO Box 14070
Portland, OR 97214
1-800-433-5177
1-503-797-4207

Signal Descriptions:

AD(x)

Address/Data Lines.

CLK

Clock. 33 MHz maximum.

C/BE(x)

Command, Byte Enable.

FRAME

Used to indicate whether the cycle is an address phase or or a data phase.

DEVSEL

Device Select.

IDSEL

Initialization Device Select

INT(x)

Interrupt

IRDY

Initiator Ready

LOCK

Used to manage resource locks on the PCI bus.

REQ

Request. Requests a PCI transfer.

GNT

Grant. indicates that permission to use PCI is granted.

PAR

Parity. Used for AD0-31 and C/BE0-3.

PERR

Parity Error.

RST

Reset.

SBO

Snoop Backoff.

SDONE

Snoop Done.

SERR

System Error. Indicates an address parity error for special cycles or a system error.

STOP

Asserted by Target. Requests the master to stop the current transfer cycle.

TCK

Test Clock

TDI

Test Data Input

TDO

Test Data Output

TMS

Test Mode Select

TRDY

Target Ready

TRST

Test Logic Reset

The PCI bus treats all transfers as a burst operation. Each cycle begins with an address phase followed by one or more data phases. Data phases may repeat indefinitely, but are limited by a timer that defines the maximum amount of time that the PCI device may control the bus. This timer is set by the CPU as part of the configuration space. Each device has its own timer (see the Latency Timer in the configuration space).

The same lines are used for address and data. The command lines are also used for byte enable lines. This is done to reduce the overall number of pins on the PCI connector.

The Command lines (C/BE3 to C/BE0) indicate the type of bus transfer during the address phase.

BETA RELEASE

C/BE Command Type

0000	Interrupt Acknowledge
0001	Special Cycle
0010	I/O Read
0011	I/O Write
0100	reserved
0101	reserved
0110	Memory Read
0111	Memory Write
1000	reserved
1001	reserved
1010	Configuration Read
1011	Configuration Write
1100	Multiple Memory Read
1101	Dual Address Cycle
1110	Memory-Read Line
1111	Memory Write and Invalidate

The three basic types of transfers are I/O, Memory, and Configuration.

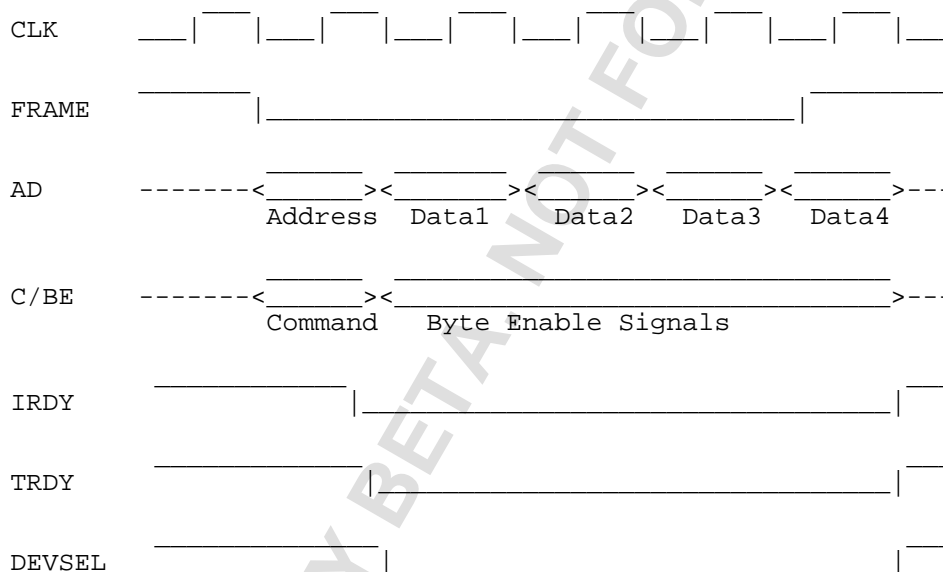
PCI timing diagrams:

PCI transfer cycle, 4 data phases, no wait states. Data is transferred on the rising edge of CLK.

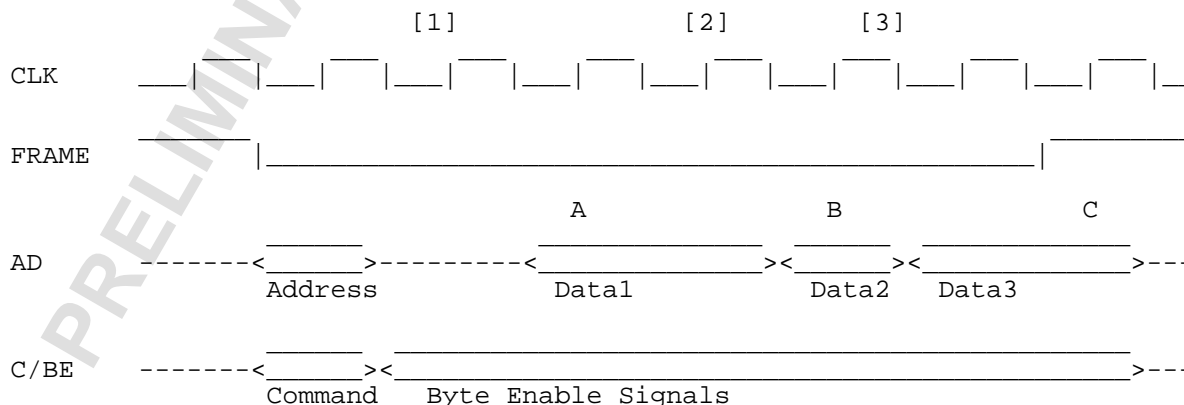

BETA RELEASE

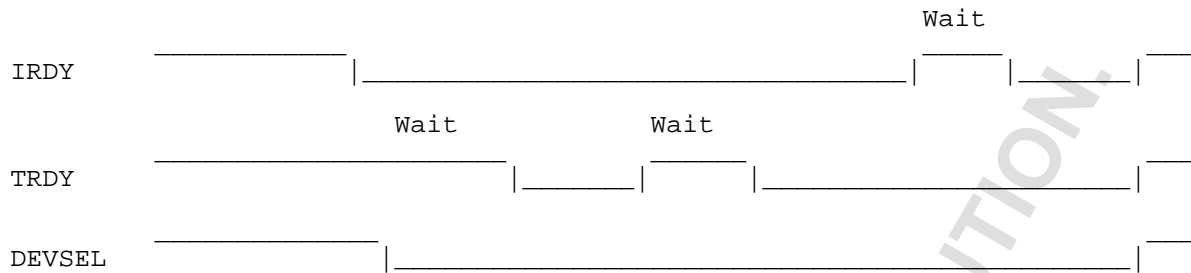

PCI transfer cycle, with wait states. Data is transferred on the rising edge of CLK at points labeled A, B, and C.

Bus Cycles:

Interrupt Acknowledge (0000)

The interrupt controller automatically recognizes and reacts to the INTA (interrupt acknowledge) command. In the data phase, it transfers the interrupt vector to the AD lines.

Special Cycle (0001)

AD15-AD0	Description
0x0000	Processor Shutdown
0x0001	Processor Halt
0x0002	x86 Specific Code
0x0003 to 0xFFFF	Reserved

I/O Read (0010) and I/O Write (0011)

Input/Output device read or write operation. The AD lines contain a byte address (AD0 and AD1 must be decoded). PCI I/O ports may be 8 or 16 bits. PCI allows 32 bits of address space. On IBM compatible machines, the Intel CPU is limited to 16 bits of I/O space, which is further limited by some ISA cards that may also be installed in the machine (many ISA cards only decode the lower 10 bits of address space, and thus mirror themselves throughout the 16 bit I/O space). This limit assumes that the machine supports ISA or EISA slots in addition to PCI slots.

The PCI configuration space may also be accessed through I/O ports 0x0CF8 (Address) and 0x0CFC (Data). The address port must be written first.

Memory Read (0110) and Memory Write (0111)

A read or write to the system memory space. The AD lines contain a doubleword address. AD0 and AD1 do not need to be decoded. The Byte Enable lines (C/BE) indicate which bytes are valid.

Configuration Read (1010) and Configuration Write (1011)

A read or write to the PCI device configuration space, which is 256 bytes in length. It is accessed in doubleword units. AD0 and AD1 contain 0, AD2-7 contain the doubleword address, AD8-10 are used for selecting the addressed unit a the malfunction unit, and the remaining AD lines are not used.

Address	Bit 32	16	15	0
00	Unit ID		Manufacturer ID	
04	Status		Command	
08	Class Code			
0C	BIST	Header	Latency	Revision
10-24	Base Address Register			
28	Reserved			
2C	Reserved			
30	Expansion ROM Base Address			

34	Reserved
38	Reserved
3C	MaxLat MnGNT INT-pin INT-line
40-FF	available for PCI unit

Multiple Memory Read (1100)

This is an extension of the memory read bus cycle. It is used to read large blocks of memory without caching, which is beneficial for long sequential memory accesses.

Dual Address Cycle (1101)

Two address cycles are necessary when a 64 bit address is used, but only a 32 bit physical address exists. The least significant portion of the address is placed on the AD lines first, followed by the most significant 32 bits. The second address cycle also contains the command for the type of transfer (I/O, Memory, etc). The PCI bus supports a 64 bit I/O address space, although this is not available on Intel based PCs due to limitations of the CPU.

Memory-Read Line (1110)

This cycle is used to read in more than two 32 bit data blocks, typically up to the end of a cache line. It is more efficient than normal memory read bursts for a long series of sequential memory accesses.

Memory Write and Invalidate (1111)

This indicates that a minimum of one cache line is to be transferred. This allows main memory to be updated, saving a cache write-back cycle.

Bus Arbitration:

This section is under construction.

PCI Bios:

This section is under construction.

Contributor: Joakim Ögren <qtech@mailhost.net>, Mark Sokos <msokos1@gl.umbc.edu>

Sources: Mark Sokos PCI page <<http://www.gl.umbc.edu/~msokos1/pci.txt>>

Sources: "Inside the PCI Local Bus" by Guy W. Kendall, Byte, February 1994 v 19 p. 177-180

Sources: "The Indispensable PC Hardware Book" by Hans-Peter Messmer, ISBN 0-201-8769-3

Please send any comments to Joakim Ögren <qtech@mailhost.net>.

VESA LocalBus (VLB)

VLB=VESA Local Bus.

VESA=Video Electronics Standards Association.

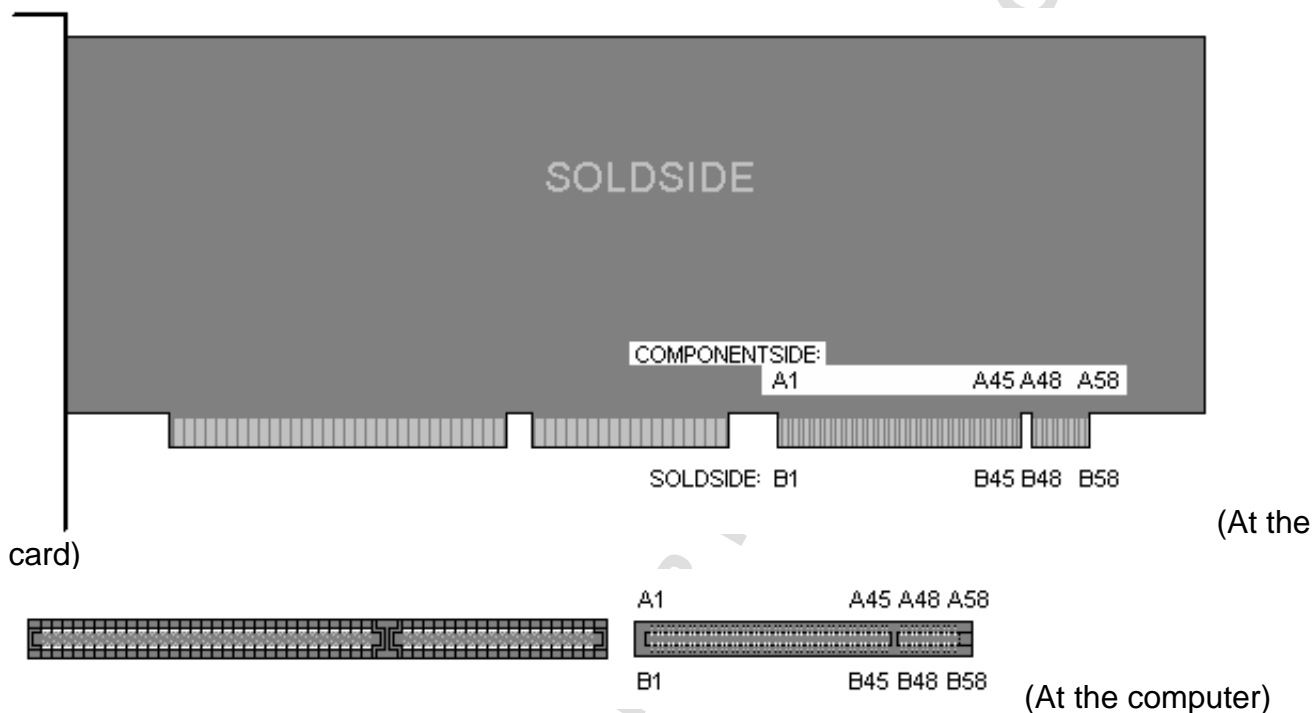

58 PIN EDGE CONNECTOR MALE at the card.

58 PIN EDGE CONNECTOR FEMALE at the computer.

Pin	Name	Description
A1	D1	Data 1
A2	D3	Data 3
A3	GND	Ground
A4	D5	Data 5
A5	D7	Data 7
A6	D9	Data 9
A7	D11	Data 11
A8	D13	Data 13
A9	D15	Data 15
A10	GND	Ground
A11	D17	Data 17
A12	Vcc	+5 VDC
A13	D19	Data 19
A14	D21	Data 21
A15	D23	Data 23
A16	D25	Data 25
A17	GND	Ground
A18	D27	Data 27
A19	D29	Data 2
A20	D31	Data 31
A21	A30	Address 30
A22	A28	Address 28
A23	A26	Address 26
A24	GND	Ground
A25	A24	Address 24
A26	A22	Address 22
A27	VCC	+5 VDC
A28	A20	Address 20

BETA RELEASE

A29	A18	Address 18
A30	A16	Address 16
A31	A14	Address 14
A32	A12	Address 12
A33	A10	Address 10
A34	A8	Address 8
A35	GND	Ground
A36	A6	Address 6
A37	A4	Address 4
A38	WBACK#	Write Back
A39	BE0#	Byte Enable 0
A40	VCC	+5 VDC
A41	BE1#	Byte Enable 1
A42	BE2#	Byte Enable 2
A43	GND	Ground
A44	BE3#	Byte Enable 3
A45	ADS#	Address Strobe
A48	LRDY#	Local Ready
A49	LDEV	Local Device
A50	LREQ	Local Request
A51	GND	Ground
A52	LGNT	Local Grant
A53	VCC	+5 VDC
A54	ID2	Identification 2
A55	ID3	Identification 3
A56	ID4	Identification 4
A57	LKEN#	
A58	LEADS#	Local Enable Address Strobe
B1	D0	Data 0
B2	D2	Data 2
B3	D4	Data 4
B4	D6	Data 6
B5	D8	Data 8
B6	GND	Ground
B7	D10	Data 10
B8	D12	Data 12
B9	VCC	+5 VDC
B10	D14	Data 14
B11	D16	Data 16
B12	D18	Data 18
B13	D20	Data 20
B14	GND	Ground
B15	D22	Data 22
B16	D24	Data 24
B17	D26	Data 26
B18	D28	Data 28
B19	D30	Data 30
B20	VCC	+5 VDC
B21	A31	Address 31
B22	GND	Ground
B23	A29	Address 29
B24	A27	Address 27
B25	A25	Address 25
B26	A23	Address 23
B27	A21	Address 21
B28	A19	Address 19
B29	GND	Ground
B30	A17	Address 17

BETA RELEASE

B31	A15	Address 15
B32	VCC	+5 VDC
B33	A13	Address 13
B34	A11	Address 11
B35	A9	Address 9
B36	A7	Address 7
B37	A5	Address 5
B38	GND	Ground
B39	A3	Address 3
B40	A2	Address 2
B41	n/c	Not connected
B42	RESET#	Reset
B43	DC#	Data/Command
B44	M/IO#	Memory/IO
B45	W/R#	Write/Read
B48	RDYRTN#	Ready Return
B49	GND	Ground
B50	IRQ9	Interrupt 9
B51	BRDY#	Burst Ready
B52	BLAST#	Burst Last
B53	ID0	Identification 0
B54	ID1	Identification 1
B55	GND	Ground
B56	LCLK	Local Clock
B57	VCC	+5 VDC
B58	LBS16#	Local Bus Size 16

Contributor: Joakim Ögren <qtech@mailhost.net>

Source: comp.sys.ibm.pc.hardware.* FAQ Part 4
<ftp://rtfm.mit.edu/pub/usenet/news.answers/pc-hardware-faq/part1>, maintained by Ralph Valentino
<ralf@alum.wpi.edu>

Please send any comments to Joakim Ögren <qtech@mailhost.net>.

VESA LocalBus (VLB) (Technical)

This section is currently based solely on the work by Mark Sokos.

This file is intended to provide a basic functional overview of the Vesa Local Bus, so that hobbyists and amateurs can design their own VLB compatible cards.

It is not intended to provide complete coverage of the VLB standard.

VLB Connectors are usually inline with ISA connectors, so that adapter cards may use both. However, the VLB is separate, and does not need to connect to the ISA portion of the bus.

The 64 bit expansion of the bus (optional) does not add additional pins or connectors. Instead, it multiplexes the existing pins. The 32 bit VLB bus does not use the 64 bit signals shown in the above pinouts.

Signal Descriptions

A2-A31

Address Bus

ADS

Address Strobe

BE0-BE3

Byte Enable. Indicates that the 8 data lines corresponding to each signal will deliver valid data.

BLAST

Burst Last. Indicates a VLB Burst Cycle, which will complete with *BRDY. The VLB Burst cycle consists of an address phase followed by four data phases.

BRDY

Burst Ready. Indicates the end of the current burst transfer.

D0-D31

Data Bus. Valid bytes are indicated by *BE(x) signals.

D/C

Data/Command. Used with M/I/O and W/R to indicate the type of cycle.

M/I/O D/C W/R

0	0	0	INTA sequence
0	0	1	Halt/Special (486)
0	1	0	I/O Read
0	1	1	I/O Write
1	0	0	Instruction Fetch
1	0	1	Halt/Shutdown (386)
1	1	0	Memory Read
1	1	1	Memory Write

ID0-ID4

Identification Signals.

ID0 ID1 ID4 CPU Bus WidthBurst

0 0 0 (res)

BETA RELEASE

0	0	1	(res)		
0	1	0	486	16/32	Burst Possible
0	1	1	486	16/32	Read Burst
1	0	0	386	16/32	None
1	0	1	386	16/32	None
1	1	0	(res)		
1	1	1	486	16/32/64	Read/Write Burst

ID2 Indicates wait: 0 = 1 wait cycle (min)
1 = no wait

ID3 Indicates bus speed: 0 = greater than 33.3 MHz
1 = less than 33.3 MHz

IRQ9

Interrupt Request. Connected to IRQ9 on ISA bus. This allows standalone VLB adapters (not connected to ISA portion of the bus) to have one IRQ.

LEADS

Local Enable Address Strobe. Set low by VLB master (not CPU). Also used for cache invalidation signal.

LBS16

Local Bus Size 16. Used by slave device to indicate that it has a transfer width of only 16 bits.

LCLK

Local Clock. Runs at the same frequency as the cpu, up to 50 MHz. 66 MHz is allowed for on-board devices.

LDEV

Local Device: When appropriate address and M/IO signals are present on the bus, the VLB device must pull this line low to indicate that it is a VLB device. The VLB controller will then use the VLB bus for the transfer.

LRDY

Local Ready. Indicates that the VLB device has completed the cycle. This signal is only used for single cycle transfers. *BRDY is used for burst transfers.

LGNT

Local Grant. Indicates that an *LREQ signal has been granted, and control is being transferred to the new VLB master.

LREQ

Local Request. Used by VLB Master to gain control of the bus.

M/IO

Memory/IO. See D/C for signal description.

RDYRTN

Ready Return. Indicates VLB cycle has been completed. May precede LRDY by one cycle.

RESET

Reset. Resets all VLB devices.

WBACK

Write Back.

64-bit Expansion Signals

ACK64

Acknowledge 64 bit transfer. Indicates that the device can perform the requested 64 bit transfer cycle.

BE4-BE7

Byte Enable. Indicates which bytes are valid (similar to BE0-BE3).

D32-D63

Upper 32 bits of data bus. Multiplexed with address bus.

LBS64

Local Bus Size 64 bits. Used by VLB Master to indicate that it desires a 64 bit transfer.

W/R

Write/Read. See D/C for signal description.

64 Bit Data Transfer Timing Diagram:

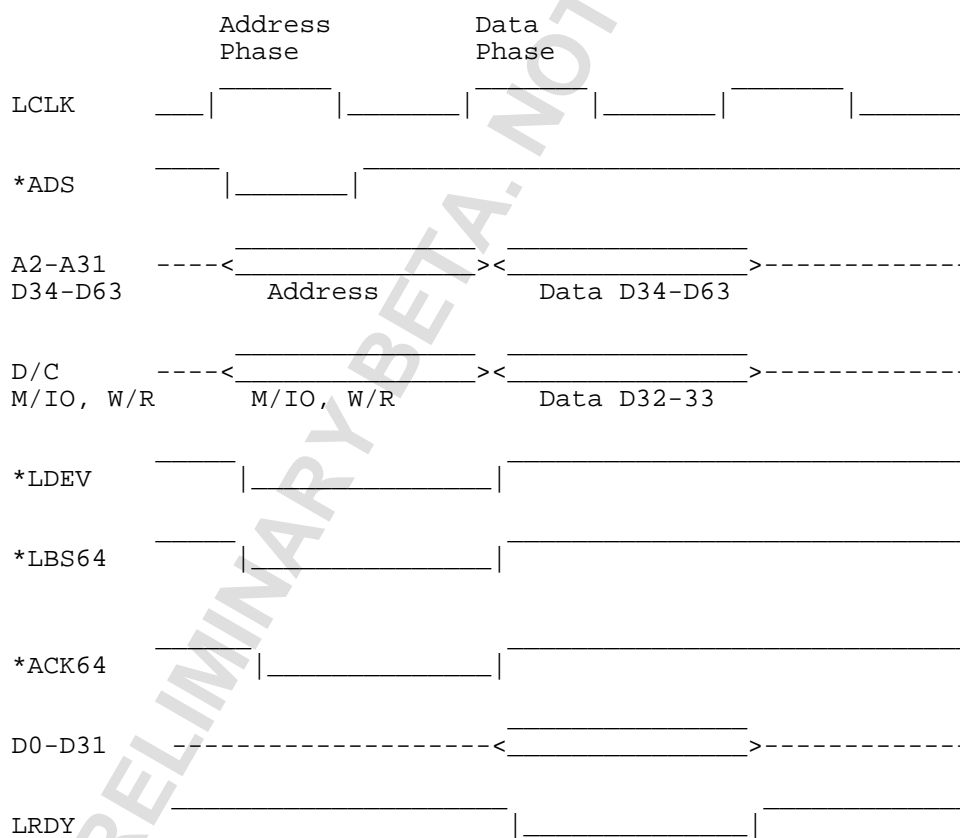

Contributor: Joakim Ögren <qtech@mailhost.net>, Mark Sokos <msokos1@gl.umbc.edu>

Sources: Mark Sokos VLB page <<http://www.gl.umbc.edu/~msokos1/vlb.txt>>

Sources: "The Indispensable PC Hardware Book" by Hans-Peter Messmer, ISBN 0-201-8769-3

Please send any comments to Joakim Ögren <qtech@mailhost.net>.

BETA RELEASE

CompactPCI

PCI=Peripheral Component Interconnect.

CompactPCI is a version of PCI adapted for industrial and/or embedded applications.

NOT

DRAWN

YET...



(At the backplane)

NOT

DRAWN

YET...



(At the device (card))

7x47 PIN (IEC917 and IEC1076-4-101) CONNECTOR at the backplane.

7x47 PIN (IEC917 and IEC1076-4-101) CONNECTOR at the device (card).

Pin	Name	Description
Z1	GND	Ground
Z2	GND	Ground
Z3	GND	Ground
Z4	GND	Ground
Z5	GND	Ground
Z6	GND	Ground
Z7	GND	Ground
Z8	GND	Ground
Z9	GND	Ground
Z10	GND	Ground
Z11	GND	Ground
Z12	KEY	Keyed (no pin)
Z13	KEY	Keyed (no pin)
Z14	KEY	Keyed (no pin)
Z15	GND	Ground
Z16	GND	Ground
Z17	GND	Ground
Z18	GND	Ground
Z19	GND	Ground
Z20	GND	Ground
Z21	GND	Ground
Z22	GND	Ground
Z23	GND	Ground
Z24	GND	Ground
Z25	GND	Ground
Z26	GND	Ground
Z27	GND	Ground
Z28	GND	Ground
Z29	GND	Ground
Z30	GND	Ground
Z31	GND	Ground
Z32	GND	Ground
Z33	GND	Ground
Z34	GND	Ground
Z35	GND	Ground
Z36	GND	Ground
Z37	GND	Ground
Z38	GND	Ground
Z39	GND	Ground
Z40	GND	Ground
Z41	GND	Ground

BETA RELEASE

Z42	GND	Ground
Z43	GND	Ground
Z44	GND	Ground
Z45	GND	Ground
Z46	GND	Ground
Z47	GND	Ground
A1	5V	+5 VDC
A2	TCK	Test Clock
A3	INTA#	Interrupt A
A4	BRSV	Bused Reserved (don't use)
A5	BRSV	Bused Reserved (don't use)
A6	REQ#	Request PCI transfer
A7	AD(30)	Address/Data 30
A8	AD(26)	Address/Data 26
A9	C/BE(3)#	Command: Byte Enable
A10	AD(21)	Address/Data 21
A11	AD(18)	Address/Data 18
A12	KEY	Keyed (no pin)
A13	KEY	Keyed (no pin)
A14	KEY	Keyed (no pin)
A15	3.3V	+3.3 VDC
A16	DEVSEL#	Device Select
A17	3.3V	+3.3 VDC
A18	SERR#	System Error
A19	3.3V	+3.3 VDC
A20	AD(12)	Address/Data 12
A21	3.3V	+3.3 VDC
A22	AD(7)	Address/Data 7)
A23	3.3V	+3.3 VDC
A24	AD(1)	Address/Data 1)
A25	5V	+5 VDC
A26	CLK1	Clock ?? MHz
A27	CLK2	Clock ?? MHz
A28	CLK4	Clock ?? MHz
A29	V(I/O)	+3.3 VDC or +5 VDC
A30	C/BE(5)#	Command: Byte Enable
A31	AD(63)	Address/Data 63
A32	AD(59)	Address/Data 59
A33	AD(56)	Address/Data 56
A34	AD(52)	Address/Data 52
A35	AD(49)	Address/Data 49
A36	AD(45)	Address/Data 45
A37	AD(42)	Address/Data 42
A38	AD(38)	Address/Data 38
A39	AD(35)	Address/Data 35
A40	BRSV	Bused Reserved (don't use)
A41	BRSV	Bused Reserved (don't use)
A42	BRSV	Bused Reserved (don't use)
A43	USR	User Defined
A44	USR	User Defined
A45	USR	User Defined
A46	USR	User Defined
A47	USR	User Defined
B1	-12V	-12 VDC
B2	5V	+5 VDC
B3	INTB#	Interrupt B
B4	GND	Ground
B5	BRSV	Bused Reserved (don't use)

BETA RELEASE

B6	GND	Ground
B7	AD(29)	Address/Data 29
B8	GND	Ground
B9	IDSEL	Initialization Device Select
B10	GND	Ground
B11	AD(17)	Address/Data 17
B12	KEY	Keyed (no pin)
B13	KEY	Keyed (no pin)
B14	KEY	Keyed (no pin)
B15	FRAME#	Address or Data phase
B16	GND	Ground
B17	SDONE	Snoop Done
B18	GND	Ground
B19	AD(15)	Address/Data 15
B20	GND	Ground
B21	AD(9)	Address/Data 9)
B22	GND	Ground
B23	AD(4)	Address/Data 4)
B24	5V	+5 VDC
B25	REQ64#	
B26	GND	Ground
B27	CLK3	Clock ?? MHz
B28	GND	Ground
B29	BRSV	Bused Reserved (don't use)
B30	GND	Ground
B31	AD(62)	Address/Data 62
B32	GND	Ground
B33	AD(55)	Address/Data 55
B34	GND	Ground
B35	AD(48)	Address/Data 48
B36	GND	Ground
B37	AD(41)	Address/Data 41
B38	GND	Ground
B39	AD(34)	Address/Data 34
B40	GND	Ground
B41	BRSV	Bused Reserved (don't use)
B42	GND	Ground
B43	USR	User Defined
B44	USR	User Defined
B45	USR	User Defined
B46	USR	User Defined
B47	USR	User Defined
C1	TRST#	Test Logic Reset
C2	TMS	Test Mode Select
C3	INTC#	Interrupt C
C4	V(I/O)	+3.3 VDC or +5 VDC
C5	RST	Reset
C6	3.3V	+3.3 VDC
C7	AD(28)	Address/Data 28
C8	V(I/O)	+3.3 VDC or +5 VDC
C9	AD(23)	Address/Data 23
C10	3.3V	+3.3 VDC
C11	AD(16)	Address/Data 16
C12	KEY	Keyed (no pin)
C13	KEY	Keyed (no pin)
C14	KEY	Keyed (no pin)
C15	IRDY#	Initiator Ready
C16	V(I/O)	+3.3 VDC or +5 VDC
C17	SBO#	Snoop Backoff

BETA RELEASE

C18	3.3V	+3.3 VDC
C19	AD(14)	Address/Data 14
C20	V(I/O)	+3.3 VDC or +5 VDC
C21	AD(8)	Address/Data 8)
C22	3.3V	+3.3 VDC
C23	AD(3)	Address/Data 3)
C24	V(I/O)	+3.3 VDC or +5 VDC
C25	BRSV	Bused Reserved (don't use)
C26	REQ1#	Request PCI transfer
C27	SYSEN#	
C28	GNT3#	Grant
C29	C/BE(7)	Command: Byte Enable
C30	V(I/O)	+3.3 VDC or +5 VDC
C31	AD(61)	Address/Data 61
C32	V(I/O)	+3.3 VDC or +5 VDC
C33	AD(54)	Address/Data 54
C34	V(I/O)	+3.3 VDC or +5 VDC
C35	AD(47)	Address/Data 47
C36	V(I/O)	+3.3 VDC or +5 VDC
C37	AD(40)	Address/Data 40
C38	V(I/O)	+3.3 VDC or +5 VDC
C39	AD(33)	Address/Data 33
C40	FAL#	Power Supply Status FAL (CompactPCI specific)
C41	DEG#	Power Supply Status DEG (CompactPCI specific)
C42	PRST#	Push Button Reset (CompactPCI specific)
C43	USR	User Defined
C44	USR	User Defined
C45	USR	User Defined
C46	USR	User Defined
C47	USR	User Defined
D1	+12V	+12 VDC
D2	TDO	Test Data Output
D3	5V	+5 VDC
D4	INTP	
D5	GND	Ground
D6	CLK	
D7	GND	Ground
D8	AD(25)	Address/Data 25
D9	GND	Ground
D10	AD(20)	Address/Data 20
D11	GND	Ground
D12	KEY	Keyed (no pin)
D13	KEY	Keyed (no pin)
D14	KEY	Keyed (no pin)
D15	GND	Ground
D16	STOP#	Stop transfer cycle
D17	GND	Ground
D18	PAR	Parity for AD0-31 & C/BE0-3
D19	GND	Ground
D20	AD(11)	Address/Data 11
D21	M66EN	
D22	AD(6)	Address/Data 6)
D23	5V	+5 VDC
D24	AD(0)	Address/Data 0)
D25	3.3V	+3.3 VDC
D26	GNT1#	Grant
D27	GNT2#	Grant
D28	REQ4#	Request PCI transfer
D29	GND	Ground

BETA RELEASE

D30	C/BE(4)#	Command: Byte Enable
D31	GND	Ground
D32	AD(58)	Address/Data 58
D33	GND	Ground
D34	AD(51)	Address/Data 51
D35	GND	Ground
D36	AD(44)	Address/Data 44
D37	GND	Ground
D38	AD(37)	Address/Data 37
D39	GND	Ground
D40	REQ5#	Request PCI transfer
D41	GND	Ground
D42	REQ6#	Request PCI transfer
D43	USR	User Defined
D44	USR	User Defined
D45	USR	User Defined
D46	USR	User Defined
D47	USR	User Defined
E1	5V	+5 VDC
E2	TDI	Test Data Input
E3	INTD#	Interrupt D
E4	INTS	
E5	GNT#	Grant
E6	AD(31)	Address/Data 31
E7	AD(27)	Address/Data 27
E8	AD(24)	Address/Data 24
E9	AD(22)	Address/Data 22
E10	AD(19)	Address/Data 19
E11	C/BE(2)#	Command: Byte Enable
E12	KEY	Keyed (no pin)
E13	KEY	Keyed (no pin)
E14	KEY	Keyed (no pin)
E15	TRDY#	Target Ready
E16	LOCK#	Lock resource
E17	PERR#	Parity Error
E18	C/BE(1)#	Command: Byte Enable
E19	AD(13)	Address/Data 13
E20	AD(10)	Address/Data 10
E21	C/BE(0)#	Command: Byte Enable
E22	AD(5)	Address/Data 5)
E23	AD(2)	Address/Data 2)
E24	ACK64#	
E25	5V	+5 VDC
E26	REQ2#	Request PCI transfer
E27	REQ3#	Request PCI transfer
E28	GNT4#	Grant
E29	C/BE(6)#	Command: Byte Enable
E30	PAR64	
E31	AD(60)	Address/Data 60
E32	AD(57)	Address/Data 57
E33	AD(53)	Address/Data 53
E34	AD(50)	Address/Data 50
E35	AD(46)	Address/Data 46
E36	AD(43)	Address/Data 43
E37	AD(39)	Address/Data 39
E38	AD(36)	Address/Data 36
E39	AD(32)	Address/Data 32
E40	GNT5#	Grant
E41	BRSV	Bused Reserved (don't use)

BETA RELEASE

E42	GNT6#	Grant
E43	USR	User Defined
E44	USR	User Defined
E45	USR	User Defined
E46	USR	User Defined
E47	USR	User Defined
F1	GND	Ground
F2	GND	Ground
F3	GND	Ground
F4	GND	Ground
F5	GND	Ground
F6	GND	Ground
F7	GND	Ground
F8	GND	Ground
F9	GND	Ground
F10	GND	Ground
F11	GND	Ground
F12	KEY	Keyed (no pin)
F13	KEY	Keyed (no pin)
F14	KEY	Keyed (no pin)
F15	GND	Ground
F16	GND	Ground
F17	GND	Ground
F18	GND	Ground
F19	GND	Ground
F20	GND	Ground
F21	GND	Ground
F22	GND	Ground
F23	GND	Ground
F24	GND	Ground
F25	GND	Ground
F26	GND	Ground
F27	GND	Ground
F28	GND	Ground
F29	GND	Ground
F30	GND	Ground
F31	GND	Ground
F32	GND	Ground
F33	GND	Ground
F34	GND	Ground
F35	GND	Ground
F36	GND	Ground
F37	GND	Ground
F38	GND	Ground
F39	GND	Ground
F40	GND	Ground
F41	GND	Ground
F42	GND	Ground
F43	GND	Ground
F44	GND	Ground
F45	GND	Ground
F46	GND	Ground
F47	GND	Ground

Contributor: Joakim Ögren <qtech@mailhost.net>

Sources: CompactPCI specifications v1.0 <<http://www.compactpci.com/cspec.htm>> at CompactPCI's homepage <<http://www.compactpci.com/>>

Sources: Mark Sokos PCI page <<http://www.gl.umbc.edu/~msokos1/pci.txt>>

Sources: "Inside the PCI Local Bus" by Guy W. Kendall, Byte, February 1994 v 19 p. 177-180

BETA RELEASE

Sources: "The Indispensable PC Hardware Book" by Hans-Peter Messmer, ISBN 0-201-8769-3

Please send any comments to Joakim Ögren <qtech@mailhost.net>.

The Hardware Book is freely distributable but is copyrighted to Joakim Ögren. It may not be modified and re-distributed without the authors permission.

PRELIMINARY BETA. NOT FOR REDISTRIBUTION.

BETA RELEASE

CompactPCI (Technical)

This section does not currently contain so much in depth information as I would like.

Since CompactPCI is based on PCI you should first refer to the PCI standard. This only explains the extensions CompactPCI specifies.

For a copy of the full CompactPCI standard, contact:

*PCI Industrial Computer Manufacturers Group (PICMG)
c/o Roger Communications
301 Edgewater place
Suite 220
Wakewater
MA01880
Phone: 1-617-224-1100
Fax: 1-617-224-1239*

Overview:

A CompactPCI system is composed of up to eight CompactPCI card locations:

- One System Slot
- Up to seven Peripheral Slots

The connector has 7 columns with 47 rows. They're divided into groups:

- Row 1-25: 32-bit PCI
- Row 26-47: Additional pins for 64-bit PCI (System Slot boards must use it).
- Row 26-28 and 40-42: Primarily implemented on System Slot boards.

The following signals must be terminated:

- AD0-31
- C/BE0#-C/BE3#
- PAR
- FRAME#
- IRDY#
- TRDY#
- STOP#
- LOCK#
- IDSEL
- DEVSEL#
- PERR#
- SERR#
- RST#

The following signals must be terminated if used:

- INTA#
- INTB#
- INTC#
- INTD#
- SB0#
- SDOBE
- AD32-AD63
- C/BE4#-C/BE7#
- REQ64#
- ACK64#

BETA RELEASE

- PAR64#

The following signals do not require a stub termination:

- CLK
- REQ#
- GNT#
- TDI#
- TDO
- TCK
- TMS
- TRST#

The System Slot board must pullup the following signals (even if not used):

- REQ64#
- ACK64#

Connector:

1	GND	5V	-12V	TRST#	12V	5V	GND
2	GND	TCK	5V	TMS	DO	TDI	GND
3	GND	INTA#	INTB#	INTC#	5V	INTD#	GND
4	GND	BRSV	GND	V(I/O)	INTP	INTS	GND
5	GND	BRSV	BRSV	RST	GND	GNT#	GND
6	GND	REQ#	GND	3.3V	CLK	AD(31)	GND
7	GND	AD(30)	AD(29)	AD(28)	GND	AD(27)	GND
8	GND	AD(26)	GND	V(I/O)	AD(25)	AD(24)	GND
9	GND	C/BE(3)#	IDSEL	AD(23)	GND	AD(22)	GND
10	GND	AD(21)	GND	3.3V	AD(20)	AD(19)	GND
11	GND	AD(18)	AS(17)	AD(16)	GND	C/BE(2)#	GND
12	KEY	KEY	KEY	KEY	KEY	KEY	KEY
13	KEY	KEY	KEY	KEY	KEY	KEY	KEY
14	KEY	KEY	KEY	KEY	KEY	KEY	KEY
15	GND	3.3V	FRAME#	IRDY#	GND	TRDY#	GND
16	GND	DEVSEL#	GND	V(I/O)	STOP#	LOCK#	GND
17	GND	3.3V	SDONE	SBO#	GND	PERR#	GND
18	GND	SERR#	GND	3.3V	PAR	C/BE(1)#	GND
19	GND	3.3V	AD(15)	AD(14)	GND	AD(13)	GND
20	GND	AD(12)	GND	V(I/O)	AD(11)	AD(10)	GND
21	GND	3.3V	AD(9)	AD(8)	M66EN	C/BE(0)#	GND
22	GND	AD(7)	GND	3.3V	AD(6)	AD(5)	GND
23	GND	3.3V	AD(4)	AD(3)	5V	AD(2)	GND
24	GND	AD(1)	5V	V(I/O)	AD(0)	ACK64#	GND
25	GND	5V	REQ64#	BRSV	3.3V	5V	GND
26	GND	CLK1	GND	REQ1#	GNT1#	REQ2#	GND
27	GND	CLK2	CLK3	SYSEN#	GNT2#	REQ3#	GND
28	GND	CLK4	GND	GNT3#	REQ4#	GNT4#	GND
29	GND	V(I/O)	BRSV	C/BE(7)	GND	C/BE(6)#	GND
30	GND	C/BE(5)#	GND	V(I/O)	C/BE(4)#	PAR64	GND
31	GND	AD(63)	AD(62)	AD(61)	GND	AD(60)	GND
32	GND	AD(59)	GND	V(I/O)	AD(58)	AD(57)	GND
33	GND	AD(56)	AD(55)	AD(54)	GND	AD(53)	GND
34	GND	AD(52)	GND	V(I/O)	AD(51)	AD(50)	GND
35	GND	AD(49)	AD(48)	AD(47)	GND	AD(46)	GND
36	GND	AD(45)	GND	V(I/O)	AD(44)	AD(43)	GND
37	GND	AD(42)	AD(41)	AD(40)	GND	AD(39)	GND
38	GND	AD(38)	GND	V(I/O)	AD(37)	AD(36)	GND
39	GND	AD(35)	AD(34)	AD(33)	GND	AD(32)	GND
40	GND	BRSV	GND	FAL#	REQ5#	GNT5#	GND

BETA RELEASE

41	GND	BRSV	BRSV	DEG#	GND	BRSV	GND
42	GND	BRSV	GND	PRST#	REQ6#	GNT6#	GND
43	GND	USR	USR	USR	USR	USR	GND
44	GND	USR	USR	USR	USR	USR	GND
45	GND	USR	USR	USR	USR	USR	GND
46	GND	USR	USR	USR	USR	USR	GND
47	GND	USR	USR	USR	USR	USR	GND
	Z	A	B	C	D	E	F

Signal Descriptions:

PRST

Push Button Reset.

DEG

Power Supply Status DEG

FAL

Power Supply Status FAL

SYSEN

System Slot Identification

Contributor: Joakim Ögren <qtech@mailhost.net>, Mark Sokos <msokos1@gl.umbc.edu>

Sources: CompactPCI specifications v1.0 <<http://www.compactpci.com/cspeak.htm>> at CompactPCI's homepage <<http://www.compactpci.com/>>

Sources: Mark Sokos PCI page <<http://www.gl.umbc.edu/~msokos1/pci.txt>>

Sources: "Inside the PCI Local Bus" by Guy W. Kendall, Byte, February 1994 v 19 p. 177-180

Sources: "The Indispensable PC Hardware Book" by Hans-Peter Messmer, ISBN 0-201-8769-3

Info: CompactPCI - An Open Industrial Computer Standard <<http://www.eetoolbox.com/vtc/pavj1/pavjp.htm>> article by Joseph S. Pavlat <jpavlat@prolog.com>

Please send any comments to Joakim Ögren <qtech@mailhost.net>.

IndustrialPCI (IPCI)

PCI=Peripheral Component Interconnect.

IndustrialPCI is a a version of PCI adapted for industrial and/or embedded applications.

The IPCI connector has three parts:

- Optional 60 pin PCI 64 bit extension (Top)
- Mandatory 120 pin PCI 32 bit (Middle)
- Optional 60 pin Custom I/O (Bottom)

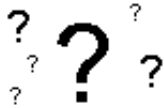

(At the backplane)

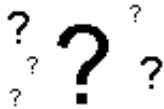

(At the device (card))

UNKNOWN CONNECTOR at the backplane.

UNKNOWN CONNECTOR at the device (card).

System Slot (Middle)

Pin	Name	Description	Note
A1	+3,3V	+3.3 VDC	
A2	AD2	Address 2	
A3	AD6	Address 6	
A4	GND	Ground	
A5	AD10	Address 10	
A6	AD13	Address 13	
A7	GND	Ground	
A8	SDONE	Snoop Done	1
A9	GND	Ground	
A10	FRAME#	Indicate Address or Data phase	1
A11	AD18	Address 18	
A12	GND	Ground	
A13	+5V	+5 VDC	
A14	AD24	Address 24	
A15	AD27	Address 27	
A16	GND	Ground	
A17	REQ2	Request 2	1
A18	GND	Ground	
A19	CLK1	33 or 66 MHz Clock	
A20	CLK2		
A21	GND	Ground	
A22	CLK3		
A23	CLK4		
A24	+3,3V	+3.3 VDC	
B1	REQ64#	Request 64 ???	1
B2	AD3	Address 3	
B3	+5V	+5 VDC	
B4	AD8	Address 8	
B5	+3,3V	+3.3 VDC	
B6	AD14	Address 14	
B7	PAR	Parity	
B8	+3,3V	+3.3 VDC	
B9	STOP#	Stop	1

BETA RELEASE

B10	C/BE2#	Command, Byte Enable 2	
B11	V(I/O)	+3.3 or +5 VDC	
B12	AD21	Address 21	
B13	+3,3V	+3.3 VDC	
B14	V(I/O)	+3.3 or +5 VDC	
B15	AD28	Address 28	
B16	AD31	Address 31	
B17	+3,3V	+3.3 VDC	
B18	GNT3	Grant 3	
B19	RST#	Reset	
B20	NMI#	Non Maskable Interrupt	
B21	X6	Reserved (6)	
B22	+5V	+5 VDC	:
B23	RSTIN#		2
B24	USB+	Universal Serial Bus (USB)(+)	
C1	ACK64#	Acknowledge 64 ???	1
C2	GND	Ground	
C3	AD7	Address 7	
C4	AD9	Address 9	
C5	AD11	Address 11	
C6	GND	Ground	
C7	SERR#	System Error	1
C8	PERR#	Parity Error	1
C9	DEVSEL#	Device Select	1
C10	GND	Ground	
C11	AD19	Address 19	
C12	AD22	Address 22	
C13	GND	Ground	
C14	AD25	Address 25	
C15	GND	Ground	
C16	X1	Reserved (1)	
C17	GNT2	Grant 2	
C18	REQ4	Request 4	1
C19	SLEEP#/SDAT	Sleep/Serial Data (I2C)	3
C20	X4	Reserved (4)	
C21	INTD#	Interrupt D	1
C22	INTB#	Interrupt B	1
C23	+5V	+5 VDC	
C24	USB-	Universal Serial Bus (USB)(-)	
D1	AD0	Address 0	
D2	AD4	Address 4	
D3	C/BE0#	Command, Byte Enable 0	
D4	+3,3V	+3.3 VDC	
D5	AD12	Address 12	
D6	AD15	Address 15	
D7	V(I/O)	+3.3 or +5 VDC	
D8	LOCK#	Resource Lock	1
D9	TRDY#	Test Logic Ready	1
D10	AD16	Address 16	
D11	AD20	Address 20	
D12	+5V	+5 VDC	
D13	+5V	+5 VDC	
D14	AD26	Address 26	
D15	AD29	Address 29	
D16	REQ1	Request 1	1
D17	REQ3	Request 3	1
D18	V(I/O)	+3.3 or +5 VDC	
D19	X2	Reserved (2)	
D20	X5	Reserved (5)	
D21	+3,3V	+3.3 VDC	

BETA RELEASE

D22	INTA#	Interrupt A	1
D23	ICPEN#/SCLK	ICPEN/Serial Clock (I2C)	3
D24	OSC (PWDN)		
E1	AD1	Address 1	
E2	AD5	Address 5	
E3	GND	Ground	
E4	M66EN	Enable 66Mhz PCI-bus	
E5	GND	Ground	
E6	C/BE1#	Command, Byte Enable 1	
E7	SBO#	Snoop Backoff	1
E8	+5V	+5 VDC	
E9	IRDY#	Initiator Ready	1
E10	AD17	Address 17	
E11	GND	Ground	
E12	AD23	Address 23	
E13	C/BE3#	Command, Byte Enable 3	
E14	GND	Ground	
E15	AD30	Address 30	
E16	GNT1	Grant 1	
E17	+5V	+5 VDC	
E18	GNT4	Grant 4	
E19	X3	Reserved (3)	
E20	GND	Ground	
E21	INTC#	Interrupt C	1
E22	-12V	-12 VDC	
E23	+12V	+12 VDC	
E24	VBATT		

1 = Pullup resistor of 2,7 kW on the System Slot (CPU).

2 = Pullup resistor of 330 W on the System Slot (CPU).

3 = Pullup resistor of 4,7 kW, if not supported by the System Slot (CPU).

Module Bus Slot (Middle)

Pin	Name	Description	Note
A1	+3,3V	+3.3 VDC	
A2	AD2	Address 2	
A3	AD6	Address 6	
A4	GND	Ground	
A5	AD10	Address 10	
A6	AD13	Address 13	
A7	GND	Ground	
A8	SDONE	Snoop Done	1
A9	GND	Ground	
A10	FRAME#	Indicate Address or Data phase	1
A11	AD18	Address 18	
A12	GND	Ground	
A13	+5V	+5 VDC	
A14	AD24	Address 24	
A15	AD27	Address 27	
A16	GND	Ground	
A17	REQ2	Request 2	1
A18	CLKM		
A19	CLK1	33 or 66 MHz Clock	
A20	CLK2		
A21	GND	Ground	
A22	CLK3		
A23	CLK4		
A24	+3,3V	+3.3 VDC	
B1	REQ64#	Request 64 ???	1

BETA RELEASE

B2	AD3	Address 3	
B3	+5V	+5 VDC	
B4	AD8	Address 8	
B5	+3,3V	+3.3 VDC	
B6	AD14	Address 14	
B7	PAR	Parity	
B8	+3,3V	+3.3 VDC	
B9	STOP#	Stop	1
B10	C/BE2#	Command, Byte Enable 2	
B11	V(I/O)	+3.3 or +5 VDC	
B12	AD21	Address 21	
B13	+3,3V	+3.3 VDC	
B14	V(I/O)	+3.3 or +5 VDC	
B15	AD28	Address 28	
B16	AD31	Address 31	
B17	+3,3V	+3.3 VDC	
B18	GNT3	Grant 3	
B19	RST#	Reset	
B20	NMI#	Non Maskable Interrupt	
B21	X6	Reserved (6)	
B22	+5V	+5 VDC	:
B23	RSTIN#		
B24	USB+	Universal Serial Bus (USB)(+)	
C1	ACK64#	Acknowledge 64 ???	1
C2	GND	Ground	
C3	AD7	Address 7	
C4	AD9	Address 9	
C5	AD11	Address 11	
C6	GND	Ground	
C7	SERR#	System Error	1
C8	PERR#	Parity Error	1
C9	DEVSEL#	Device Select	1
C10	GND	Ground	
C11	AD19	Address 19	
C12	AD22	Address 22	
C13	GND	Ground	
C14	AD25	Address 25	
C15	GND	Ground	
C16	X1	Reserved (1)	
C17	GNT2	Grant 2	
C18	REQ4	Request 4	1
C19	SLEEP#/SDAT	Sleep/Serial Data (I2C)	
C20	X4	Reserved (4)	
C21	INTD#	Interrupt D	1
C22	INTB#	Interrupt B	1
C23	+5V	+5 VDC	
C24	USB-	Universal Serial Bus (USB)(-)	
D1	AD0	Address 0	
D2	AD4	Address 4	
D3	C/BE0#	Command, Byte Enable 0	
D4	+3,3V	+3.3 VDC	
D5	AD12	Address 12	
D6	AD15	Address 15	
D7	V(I/O)	+3.3 or +5 VDC	
D8	LOCK#	Resource Lock	1
D9	TRDY#	Test Logic Ready	1
D10	AD16	Address 16	
D11	AD20	Address 20	
D12	+5V	+5 VDC	
D13	+5V	+5 VDC	

BETA RELEASE

D14	AD26	Address 26	
D15	AD29	Address 29	
D16	REQ1	Request 1	1
D17	REQ3	Request 3	1
D18	V(I/O)	+3.3 or +5 VDC	
D19	X2	Reserved (2)	
D20	X5	Reserved (5)	
D21	+3,3V	+3.3 VDC	
D22	INTA#	Interrupt A	1
D23	ICPEN#/SCLK	ICPEN/Serial Clock (I2C)	3
D24	OSC (PWDN)		
E1	AD1	Address 1	
E2	AD5	Address 5	
E3	GND	Ground	
E4	M66EN	Enable 66Mhz PCI-bus	
E5	GND	Ground	
E6	C/BE1#	Command, Byte Enable 1	
E7	SBO#	Snoop Backoff	1
E8	+5V	+5 VDC	
E9	IRDY#	Initiator Ready	1
E10	AD17	Address 17	
E11	GND	Ground	
E12	AD23	Address 23	
E13	C/BE3#	Command, Byte Enable 3	
E14	GND	Ground	
E15	AD30	Address 30	
E16	GNT1	Grant 1	
E17	+5V	+5 VDC	
E18	GNT4	Grant 4	
E19	X3	Reserved (3)	
E20	GND	Ground	
E21	INTC#	Interrupt C	1
E22	-12V	-12 VDC	
E23	+12V	+12 VDC	
E24	VBATT		

1 = Pullup resistor of 2,7 kW on the System Slot (CPU).

Card Slot (Middle)

Pin	Name	Description	Note
A1	+3,3V	+3.3 VDC	
A2	AD2	Address 2	
A3	AD6	Address 6	
A4	GND	Ground	
A5	AD10	Address 10	
A6	AD13	Address 13	
A7	GND	Ground	
A8	SDONE	Snoop Done	1
A9	GND	Ground	
A10	FRAME#	Indicate Address or Data phase	1
A11	AD18	Address 18	
A12	GND	Ground	
A13	+5V	+5 VDC	
A14	AD24	Address 24	
A15	AD27	Address 27	
A16	GND	Ground	
A17	IDSELO	IDSELO	1
A18	GND	Ground	
A19	CLK1	33 or 66 MHz Clock	

BETA RELEASE

A20	GND	Ground	
A21	GND	Ground	
A22	GND	Ground	
A23	GND	Ground	
A24	+3,3V	+3.3 VDC	
B1	REQ64#	Request 64 ???	1
B2	AD3	Address 3	
B3	+5V	+5 VDC	
B4	AD8	Address 8	
B5	+3,3V	+3.3 VDC	
B6	AD14	Address 14	
B7	PAR	Parity	
B8	+3,3V	+3.3 VDC	
B9	STOP#	Stop	1
B10	C/BE2#	Command, Byte Enable 2	
B11	V(I/O)	+3.3 or +5 VDC	
B12	AD21	Address 21	
B13	+3,3V	+3.3 VDC	
B14	V(I/O)	+3.3 or +5 VDC	
B15	AD28	Address 28	
B16	AD31	Address 31	
B17	+3,3V	+3.3 VDC	
B18	GND	Ground	
B19	RST#	Reset	
B20	NMI#	Non Maskable Interrupt	
B21	X6	Reserved (6)	
B22	+5V	+5 VDC	:
B23	RSTIN#		
B24	USB+	Universal Serial Bus (USB)(+)	
C1	ACK64#	Acknowledge 64 ???	1
C2	GND	Ground	
C3	AD7	Address 7	
C4	AD9	Address 9	
C5	AD11	Address 11	
C6	GND	Ground	
C7	SERR#	System Error	1
C8	PERR#	Parity Error	1
C9	DEVSEL#	Device Select	1
C10	GND	Ground	
C11	AD19	Address 19	
C12	AD22	Address 22	
C13	GND	Ground	
C14	AD25	Address 25	
C15	GND	Ground	
C16	X1	Reserved (1)	
C17	IDSEL1	Initialization Device Select 1	
C18	GND	Ground	
C19	SLEEP#/SDAT	Sleep/Serial Data (I2C)	
C20	X4	Reserved (4)	
C21	INTD#	Interrupt D	1
C22	INTB#	Interrupt B	1
C23	+5V	+5 VDC	
C24	USB-	Universal Serial Bus (USB)(-)	
D1	AD0	Address 0	
D2	AD4	Address 4	
D3	C/BE0#	Command, Byte Enable 0	
D4	+3,3V	+3.3 VDC	
D5	AD12	Address 12	
D6	AD15	Address 15	
D7	V(I/O)	+3.3 or +5 VDC	

BETA RELEASE

D8	LOCK#	Resource Lock	1
D9	TRDY#	Test Logic Ready	1
D10	AD16	Address 16	
D11	AD20	Address 20	
D12	+5V	+5 VDC	
D13	+5V	+5 VDC	
D14	AD26	Address 26	
D15	AD29	Address 29	
D16	REQ1	Request 1	1
D17	IDSEL2	Initialization Device Select 2	
D18	V(I/O)	+3.3 or +5 VDC	
D19	X2	Reserved (2)	
D20	X5	Reserved (5)	
D21	+3,3V	+3.3 VDC	
D22	INTA#	Interrupt A	1
D23	ICPEN#/SCLK	ICPEN/Serial Clock (I2C)	3
D24	OSC (PWDN)		
E1	AD1	Address 1	
E2	AD5	Address 5	
E3	GND	Ground	
E4	M66EN	Enable 66Mhz PCI-bus	
E5	GND	Ground	
E6	C/BE1#	Command, Byte Enable 1	
E7	SBO#	Snoop Backoff	1
E8	+5V	+5 VDC	
E9	IRDY#	Initiator Ready	1
E10	AD17	Address 17	
E11	GND	Ground	
E12	AD23	Address 23	
E13	C/BE3#	Command, Byte Enable 3	
E14	GND	Ground	
E15	AD30	Address 30	
E16	GNT1	Grant 1	
E17	+5V	+5 VDC	
E18	GNT4	Grant 4	
E19	X3	Reserved (3)	
E20	GND	Ground	
E21	INTC#	Interrupt C	1
E22	-12V	-12 VDC	
E23	+12V	+12 VDC	
E24	VBATT		

1 = Pullup resistor of 2,7 kW on the System Slot (CPU).

64-bit PCI (Top)

Pin	Name	Description	Note
A1	GND	Ground	
A2	X10	Reserved (10)	
A3	AD35	Address 35	2
A4	AD38	Address 38	2
A5	AD42	Address 42	2
A6	V(I/O)	+3.3 or +5 VDC	
A7	V(I/O)	+3.3 or +5 VDC	
A8	AD52	Address 52	2
A9	AD56	Address 56	2
A10	AD60	Address 60	2
A11	AD63	Address 63	2
A12	GND	Ground	
B1	X7	Reserved (7)	

BETA RELEASE

B2	GND	Ground	
B3	AD36	Address 36	2
B4	AD39	Address 39	2
B5	AD43	Address 43	2
B6	AD46	Address 46	2
B7	AD49	Address 49	2
B8	AD53	Address 53	2
B9	AD57	Address 57	2
B10	AD61	Address 61	2
B11	GND	Ground	
B12	C/BE6#	Command, Byte Enable 6	2
C1	X8	Reserved (8)	
C2	AD32	Address 32	2
C3	GND	Ground	
C4	AD40	Address 40	2
C5	AD44	Address 44	2
C6	GND	Ground	
C7	GND	Ground	
C8	AD54	Address 54	2
C9	AD58	Address 58	2
C10	GND	Ground	
C11	PAR64	Parity 64 ???	2
C12	C/BE7#	Command, Byte Enable 7	2
D1	X9	Reserved (9)	
D2	AD33	Address 33	2
D3	AD37	Address 37	2
D4	GND	Ground	
D5	AD45	Address 45	2
D6	AD47	Address 47	2
D7	AD50	Address 50	2
D8	AD55	Address 55	2
D9	GND	Ground	
D10	AD62	Address 62	2
D11	C/BE4#	Command, Byte Enable 4	2
D12	X11	Reserved (11)	
E1	GND	Ground	
E2	AD34	Address 34	2
E3	V(I/O)	+3.3 or +5 VDC	
E4	AD41	Address 41	2
E5	GND	Ground	
E6	AD48	Address 48	2
E7	AD51	Address 51	2
E8	GND	Ground	
E9	AD59	Address 59	2
E10	V(I/O)	+3.3 or +5 VDC	
E11	C/BE5#	Command, Byte Enable 5	2
E12	X12	Reserved (12)	

2 = Pullup resistor of 2,7 kW (5V bus system) or 8,2 kW (3,3V bus system) on the backplane.

ISA96/AT96 (Bottom)

Pin	Name	Description	Note
A1	RSTDRV		
A2	IRQ9	Interrupt 9	
A3	SD11	Data 11	
A4	SD9	Data 9	
A5	IOCHRDY		1
A6	IOW#	I/O Write	
A7	SA15	Address 15	

BETA RELEASE

A8	CLK	Clock	
A9	SA10	Address 10	
A10	SA7	Address 7	
A11	T/C		
A12	SA2	Address 2	
B1	SD15	Data 15	
B2	SD13	Data 13	
B3	SD3	Data 3	
B4	SD1	Data 1	
B5	SMEMW#	System Memory Write	
B6	SA18	Address 18	
B7	SA14	Address 14	
B8	DACK6#	DMA Acknowledge 6	
B9	SA9	Address 9	
B10	IRQ3	Interrupt 3	
B11	IOCS16#	I/O 16-bit chip select	1
B12	SA1	Address 1	
C1	SD7	Data 7	
C2	SD5	Data 5	
C3	SD10	Data 10	
C4	SD8	Data 8	
C5	AEN	Address Enable	
C6	IOR#	I/O Read	
C7	SA13	Address 13	
C8	SA11	Address 11	
C9	IRQ5	Interrupt 5	
C10	SA6	Address 6	
C11	SA4	Address 4	
C12	IRQ11	Interrupt 11	
D1	SD14	Data 14	
D2	SD12	Data 12	
D3	SD2	Data 2	
D4	SD0	Data 0	
D5	SMEMR#	System Memory Read	
D6	SA17	Address 17	
D7	REF#		
D8	IRQ7	Interrupt 7	
D9	SA8	Address 8	
D10	MCS16#		1
D11	BALE		
D12	SA0	Address 0	
E1	SD6	Data 6	
E2	SD4	Data 4	
E3	OWS		1
E4	SBHE#		
E5	SA19	Address 19	
E6	SA16	Address 16	
E7	SA12	Address 12	
E8	DRQ6	DMA Request 6	
E9	IRQ4	Interrupt 4	
E10	SA5	Address 5	
E11	SA3	Address 3	
E12	IRQ10	Interrupt 10	

1 = Pullup resistor must be integrated into the System Slot (CPU).

VMEbus (Bottom)

Pin	Name	Description
A1	D0	Data 0

BETA RELEASE

A2	D2	Data 2
A3	D12	Data 12
A4	D7	Data 7
A5	DS1#	
A6	BR3#	
A7	AM1	
A8	AM3	
A9	IACKOUT#	
A10	A14	Address 14
A11	A12	Address 12
A12	A10	Address 10
B1	BBSY#	
B2	D10	Data 10
B3	D5	Data 5
B4	D15	Data 15
B5	SYSRES#	
B6	A23	Address 23
B7	A21	Address 21
B8	A19	Address 19
B9	A16	Address 16
B10	A6	Address 6
B11	A4	Address 4
B12	A2	Address 2
C1	D8	Data 8
C2	D3	Data 3
C3	D13	Data 13
C4	SYSCLK	
C5	DS0#	
C6	DTACK#	
C7	AS#	
C8	IACK#	
C9	AM4	
C10	A13	Address 13
C11	A11	Address 11
C12	A9	Address 9
D1	D1	Data 1
D2	D11	Data 11
D3	D6	Data 6
D4	BG3OUT#	
D5	WR#	Write
D6	AM0	
D7	AM2	
D8	A18	Address 18
D9	A15	Address 15
D10	A5	Address 5
D11	A3	Address 3
D12	A1	Address 1
E1	D9	Data 9
E2	D4	Data 4
E3	D14	Data 14
E4	BERR#	Bus Error
E5	AM5	
E6	A22	Address 22
E7	A20	Address 20
E8	A17	Address 17
E9	A7	Address 7
E10	IRQ5#	Interrupt 5
E11	IRQ3#	Interrupt 3
E12	A8	Address 8

BETA RELEASE

ECB (Bottom)

Pin	Name	Description
A1	D5	Data 5
A2	D2	Data 2
A3	A4	Data 4
A4	A7	Address 7
A5	BAI	
A6	2F	
A7	A10	Address 10
A8	INT#	
A9	VCMOS	
A10	PWRCLR#	
A11	A13	Address 13
A12	RESET#	Reset
B1	D0	Data 0
B2	D4	Data 4
B3	A1	Address 1
B4	WAIT#	
B5	A17	Address 17
B6	IEO	
B7	n/c	Not connected
B8	DMARDY	
B9	RD#	Read
B10	IORQ#	
B11	?	
B12	n/c	Not connected
C1	D6	Data 6
C2	A0	Address 0
C3	A5	Address 5
C4	A16	Address 16
C5	A18	Address 18
C6	BAO	
C7	M1#	
C8	WR#	
C9	n	
C10	A12	Address 12
C11	A9	Address 9
C12	n/c	Not connected
D1	D7	Data 7
D2	A2	Address 2
D3	A8	Address 8
D4	BUSRQ#	
D5	A19	Address 19
D6	A11	Address 11
D7	NMI#	Non Maskable Interrupt
D8	PF	
D9	HALT#	
D10	RFSH#	
D11	MRQ#	
D12	n/c	Not connected
E1	D3	Data 3
E2	A3	Address 3
E3	A6	Address 6
E4	IEI	
E5	D1	Data 1
E6	A14	Address 14
E7	n/c	Not connected
E8	n/c	Not connected

BETA RELEASE

E9	DESLCT#	
E10	A15	Address 15
E11	BUSAK#	
E12	n/c	Not connected

SMP16 (Bottom)

Pin	Name	Description
A1	NMI#	Non Maskable Interrupt
A2	IRQ0#	Interrupt 0
A3	D11	Data 11
A4	D9	Data 9
A5	RDYIN	
A6	IOW#	
A7	A15	Address 15
A8	CLK	
A9	A10	Address 10
A10	A7	Address 7
A11	TC/EOP#	
A12	A2	Address 2
B1	D15	Data 15
B2	D13	Data 13
B3	D3	Data 3
B4	D1	Data 1
B5	MEMW#	
B6	A18	Address 18
B7	A14	Address 14
B8	DACKx#	
B9	A9	Address 9
B10	IRQ3#	Interrupt 3
B11	IOCS16#	
B12	A1	Address 1
C1	D7	Data 7
C2	D5	Data 5
C3	D10	Data 10
C4	D8	Data 8
C5	BUSEN	
C6	IOR#	
C7	A13	Address 13
C8	A11	Address 11
C9	IRQ1#	Interrupt 1
C10	A6	Address 6
C11	A4	Address 4
C12	IRQ4#	Interrupt 4
D1	D14	Data 14
D2	D12	Data 12
D3	D2	Data 2
D4	D0	Data 0
D5	MEMR#	
D6	A17	Address 17
D7	INTA#	
D8	INT#	
D9	A8	Address 8
D10	MECS16#	
D11	ALE	
D12	A0	Address 0
E1	D6	Data 6
E2	D4	Data 4
E3	MMIO#	
E4	BHEN	

BETA RELEASE

E5	A19	Address 19
E6	A16	Address 16
E7	A12	Address 12
E8	DRQx#	
E9	IRQ2#	Interrupt 2
E10	A5	Address 5
E11	A3	Address 3
E12	IRQ5#	Interrupt 5

Floppy/EIDE (Bottom)

Pin	Name	Description
A1	FDSEL1	Floppy Select 1
A2	FDSEL0	Floppy Select 0
A3	FDME1	Floppy ?
A4	DIR	Floppy Direction
A5	STEP	Floppy Step
A6	WRDATA	Floppy Write Data
A7	WE	Floppy Write?
A8	TRK0	Floppy Track 0
A9	WP	Floppy Write?
A10	RDDATA	Floppy ?
A11	HDSEL	Floppy HD Select
A12	DSKCHG	Floppy DiskChange
B1	DRV DEN1	?
B2	DRV DEN0	?
B3	IDECS3P#	IDE ?
B4	IDEA2	IDE ?
B5	IDEIRQS	IDE ?
B6	IDE PUS	IDE ?
B7	IDE DRQP	IDE ?
B8	IDE D14	IDE Data 14
B9	IDE D8	IDE Data 8
B10	IDE D6	IDE Data 6
B11	IDE D11	IDE Data 11
B12	IDE D3	IDE Data 3
C1	FDME0	Floppy Me?
C2	INDX	Floppy Index
C3	IDECS3S#	IDE ?
C4	IDEA0	IDE ?
C5	IDE DAKS#	IDE ?
C6	IDE IOR#	IDE ?
C7	IDE DRQS	IDE ?
C8	IDE D1	IDE Data 1
C9	#IDERST	IDE ?
C10	IDE D10	IDE Data 10
C11	IDE D4	IDE Data 4
C12	IDE D2	IDE Data 2
D1	IDE LED S#	IDE LED ?
D2	IDE LED P#	IDE LED ?
D3	IDECS1S#	IDE ?
D4	IDE IRQP	IDE ?
D5	IDE PUP	IDE Pull Up ?
D6	IDE IOW#	IDE ?
D7	IDE D15	IDE Data 15
D8	IDE D13	IDE Data 13
D9	IDE D7	IDE Data 7
D10	GND	Ground
D11	GND	Ground
D12	GND	Ground

BETA RELEASE

E1	GND	Ground
E2	GND	Ground
E3	IDECS1P#	IDE ?
E4	IDEA1	IDE ?
E5	IDEDAKP#	IDE ?
E6	IDEIORDY	IDE ?
E7	IDED0	IDE Data 0
E8	IDED12	IDE Data 12
E9	IDED9	IDE Data 9
E10	IDED5	IDE Data 5
E11	GND	Ground
E12	GND	Ground

SCSI (Bottom)

Pin	Name	Description
A1	TERM	
A2	GND	Ground
A3	I/O#	
A4	REQ#	
A5	ATN#	
A6	D8	Data 8
A7	D9	Data 9
A8	D10	Data 10
A9	D2	Data 2
A10	D4	Data 4
A11	DP0	
A12	GND	Ground
B1	TERM	
B2	GND	Ground
B3	GND	Ground
B4	GND	Ground
B5	GND	Ground
B6	GND	Ground
B7	GND	Ground
B8	GND	Ground
B9	GND	Ground
B10	GND	Ground
B11	GND	Ground
B12	GND	Ground
C1	TERM	
C2	GND	Ground
C3	C/D#	
C4	MSG#	
C5	ACK#	
C6	D12	Data 12
C7	DP1	Data P1
C8	D13	Data 13
C9	D1	Data 1
C10	D5	Data 5
C11	D7	Data 7
C12	GND	Ground
D1	TERM	
D2	GND	Ground
D3	GND	Ground
D4	GND	Ground
D5	GND	Ground
D6	GND	Ground
D7	GND	Ground
D8	GND	Ground

BETA RELEASE

D9	GND	Ground
D10	GND	Ground
D11	GND	Ground
D12	GND	Ground
E1	TERM	
E2	GND	Ground
E3	SEL#	
E4	RST#	
E5	BSY#	
E6	D14	Data 14
E7	D15	Data 15
E8	D11	Data 11
E9	D0	Data 0
E10	D3	Data 3
E11	D6	Data 6
E12	GND	Ground

Contributor: Joakim Ögren <qtech@mailhost.net>

Sources: IndustrialPCI page <<http://www.sips.com/ipci.htm>> at Standard Industrial PC Systems's (SIPS) homepage <<http://www.sips.com>>

Please send any comments to Joakim Ögren <qtech@mailhost.net>

PRELIMINARY BETA. NOT FOR REDISTRIBUTION.

SmallPCI (SPCI)

PCI=Peripheral Component Interconnect.

SmallPCI is a a version of PCI adapted for small computers and PDAs.

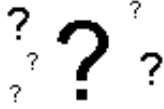

(At the motherboard)

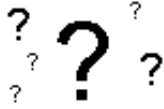

(At the device)

UNKNOWN CONNECTOR at the motherboard.

UNKNOWN CONNECTOR at the device.

I don't have any technical information about SmallPCI at the moment. If you have any information of value please send it to me.

The specifications can be obtained from:

*PCI Special Interrest Group
2575 NE Kathryn St. #17
Hillsboro, OR 97124
Phone: 1-800-433-5177
Fax: 1-503-693-8344*

Contributor: Joakim Ögren <qtech@mailhost.net>

Source: ?

Info: SmallPCI overview <<http://www.pcisig.com/current/smallpci.html>> at PCI Speacial Interrest Group's homepage <<http://www.pcisig.com>>

Please send any comments to Joakim Ögren <qtech@mailhost.net>.

Miniature Card

Developed by Intel.

Miniature Card is a memory-only expansion card.

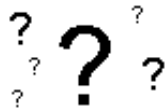

(At the device)

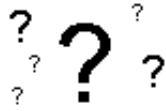

(At the card)

UNKNOWN CONNECTOR at the device.

UNKNOWN CONNECTOR at the card.

Pin	Pin Name	Description	Dir
1	A18	Address Bus	↑
2	A16	Address Bus	↑
3	A14	Address Bus	↑
4	Vccr	Voltage Refresh	↑
5	CEH#	Card Enable High Byte	↑
6	A11	Address Bus	↑
7	A9	Address Bus	↑
8	A8	Address Bus	↑
9	A6	Address Bus	↑
10	A5	Address Bus	↑
11	A3	Address Bus	↑
12	A2	Address Bus	↑
13	A0	Address Bus	↑
14	RAS#	Row Address Strobe	↑
15	A24	Address Bus	↑
16	A23	Address Bus	↑
17	A22	Address Bus	↑
18	OE#	Output Enable	↑
19	D15	Data Bus	↕
20	D13	Data Bus	↕
21	D12	Data Bus	↕
22	D10	Data Bus	↕
23	D9	Data Bus	↕
24	D0	Data Bus	↕
25	D2	Data Bus	↕
26	D4	Data Bus	↕
27	RFU	Reserved for future use	
28	D7	Data Bus	↕
29	SDA	Serial Data and Address	↕
30	SCL	Serial Clock	↑
31	A19	Address Bus	↑
32	A17	Address Bus	↑
33	A15	Address Bus	↑
34	A13	Address Bus	↑
35	A12	Address Bus	↑
36	RESET#	Reset	↑
37	A10	Address Bus	↑
38	VS1#	Voltage Sense 1	↓
39	A7	Address Bus	↑
40	BS8#	Bus Size 8	↑
41	A4	Address Bus	↑

BETA RELEASE

42	CEL#	Card Enable Low Byte	↑
43	A1	Address Bus	↑↑
44	CASL#	Column Address Strobe Low Byte	↑↑↑
45	CASH#	Column Address Strobe High Byte	↑↑↑
46	CD#	Card Detect	↓↑
47	A21	Address Bus	↑↑↑
48	BUSY#	Ready/Busy	↓↑
49	WE#	Write Enable	↑↑
50	D14	Data Bus	↑↓
51	RFU	Reserved for future use	
52	D11	Data Bus	↑↓
53	VS2#	Voltage Sense 2	↓↑
54	D8	Data Bus	↑↓
55	D1	Data Bus	↑↓
56	D3	Data Bus	↑↓
57	D5	Data Bus	↑↓
58	D6	Data Bus	↑↓
59	RFU	Reserved for future use	
60	A20	Address Bus	↑

The following three is separate:

Name	Description	Dir
GND	Ground	
VCC	Power	
CINS#	Card Insertion	→

Note: Direction is card relative device.

Contributor: Joakim Ögren <qtech@mailhost.net>

Source: Miniature Card v1.1 spec <<http://www.mcif.org/spec.html>> at Miniature Card Implementers Forum's homepage <<http://www.mcif.org/spec.html>>

Please send any comments to Joakim Ögren <qtech@mailhost.net>.

PRELIMINARY BETA. NOT FOR REDISTRIBUTION.

Miniature Card (Technical)

This section is currently based solely on the Miniature Card specification v1.1.

Signal Descriptions:

A0-A24

Address A0 to A24 are the address bus lines that can address up to 32 Mwords (64 MBytes). The Miniature Card specification does not require the Miniature Card to decode the upper address lines. A 2 Mbyte Miniature Card that does not decode the upper address lines would repeat its address space every 2 Mbytes. Address 0h would access the same physical location as 200000h, 400000h, 600000h, etc.

D0-D15

Data lines D0 through D15 constitute the data bus. The data bus is composed of two bytes, the low byte D[7:0] and the high byte D[15:8].

OE#

OE# indicates that the current bus cycle is a read cycle.

WE#

WE# indicates that the current bus cycle is a write cycle.

VS1#

Voltage Sense 1 signal. The card grounds this signal to indicate it can operate at 3.3 Volts. This signal must either be connected to card GND or left open.

VS2#

Voltage Sense 2 signal. The card grounds this signal to indicate it can operate at x.x Volts (the value to be determined at a later date). This signal must either be connected to card GND or left open.

CEL#

CEL# enables the low byte of the data bus (D[7:0]) on the card. This signal is not used in DRAM cards.

CEH#

CEH# enables the high byte of the data bus (D[15:8]) on the card. This signal is not used in DRAM cards.

RAS#

RAS# strobes in the row address for DRAM cards.

CASL#

CASL# strobes in the low byte column address for DRAM cards.

CASH#

CASH# strobes in the high byte column address for DRAM cards.

RESET#

RESET# controls card initialization. When RESET# transitions from a low state to a high state, the Miniature Card must reset to a predetermined state.

BUSY#

BUSY# is a signal generated by the card to indicate the status of operations within the Miniature Card. When BUSY# is high, the Miniature Card is ready to accept the next command from the host. When BUSY# is low, the Miniature Card is busy and unable to accept some data operations from the host. For example, in Flash Miniature Cards the BUSY# signal is tied to the components RY/BY# signal. However, ROM Miniature Cards would always drive BUSY# high since the host will always be able to read from a ROM Miniature Card.

Vccr

Vccr provides a low current (refresh) voltage supply. Vccr is a feature used by DRAM Miniature Cards to "self-refresh" during "sleep" mode.

SDA

I2C: Serial Data/Address.

SCL

I2C: Serial Clock are used to read the attribute information structure (AIS) from the serial EEPROM in a DRAM card.

CD#

CD# is a grounded interface signal. After a Miniature Card has been inserted, CD# will be forced low. The card detect signal is located in the center of the second row of interface signals, and should be one of the last interface signals to connect to the host. Do not confuse CD# with CINS#. CINS# is an early card detect that is one of the first signals to connect to the host.

BS8#

BS8# is a signal driven by the host to indicate if the data bus is x8 or x16. An 8-bit host must drive BS8# low and tie the high byte data bus D[15:8] to the low byte data bus D[7:0]. A 16-bit host must drive this signal high.

GND

Ground

Vcc

Vcc is used to supply power to the card.

CINS#

CINS# is a grounded signal on the front of the Miniature Card that can be used for early detection of a card insertion. CINS# makes contact on the host when the front of the card is inserted into the socket, before the interface signals connect.

Contributor: Joakim Ögren <qtech@mailhost.net>

Source: Miniature Card v1.1 spec <<http://www.mcif.org/spec.html>> at Miniature Card Implementers Forum's homepage <<http://www.mcif.org/spec.html>>

Please send any comments to Joakim Ögren <qtech@mailhost.net>.

NuBus

Available on old Apple Macintosh computers.

Standard: IEEE 1196, "Nubus-A simple 32-bit backplane bus"

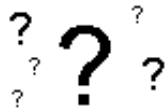

(At the card)

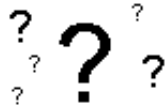

(At the computer)

UNKNOWN CONNECTOR at the card.

UNKNOWN CONNECTOR at the computer.

Row A

Pin Name	Description
1	-12 V -12 VDC
2	-
3	/SPV
4	/SP
5	/TM1
6	/AD1 Address/Data 1
7	/AD3 Address/Data 3
8	/AD5 Address/Data 5
9	/AD7 Address/Data 7
10	/AD9 Address/Data 9
11	/AD11 Address/Data 11
12	/AD13 Address/Data 13
13	/AD15 Address/Data 15
14	/AD17 Address/Data 17
15	/AD19 Address/Data 19
16	/AD21 Address/Data 21
17	/AD23 Address/Data 23
18	/AD25 Address/Data 25
19	/AD27 Address/Data 27
20	/AD29 Address/Data 29
21	/AD31 Address/Data 31
22	GND Ground
23	GND Ground
24	/ARB1
25	/ARB3
26	/ID1
27	/ID3
28	/ACK
29	+5 V +5 VDC
30	/RQST
31	/NMRQ
32	+12 V +12 VDC

Row B

Pin Name	Description
1	-12 V -12 VDC
2	GND Ground

BETA RELEASE

3	GND	Ground
4	+5 V	+5 VDC
5	+5 V	+5 VDC
6	+5 V	+5 VDC
7	+5 V	+5 VDC
8	*	Reserved ?
9	*	Reserved ?
10	*	Reserved ?
11	*	Reserved ?
12	GND	Ground
13	GND	Ground
14	GND	Ground
15	GND	Ground
16	GND	Ground
17	GND	Ground
18	GND	Ground
19	GND	Ground
20	GND	Ground
21	GND	Ground
22	GND	Ground
23	GND	Ground
24	**	Reserved ?
25	**	Reserved ?
26	**	Reserved ?
27	**	Reserved ?
28	+5 V	+5 VDC
29	+5 V	+5 VDC
30	GND	Ground
31	GND	Ground
32	+12 V	

Row C

Pin	Name	Description
1	/RESET	Reset
2	-	
3	+5 V	+5 VDC
4	+5 V	+5 VDC
5	/TM0	
6	/AD0	Address/Data 0
7	/AD2	Address/Data 2
8	/AD4	Address/Data 4
9	/AD6	Address/Data 6
10	/AD8	Address/Data 8
11	/AD10	Address/Data 10
12	/AD12	Address/Data 12
13	/AD14	Address/Data 14
14	/AD16	Address/Data 16
15	/AD18	Address/Data 18
16	/AD20	Address/Data 20
17	/AD22	Address/Data 22
18	/AD24	Address/Data 24
19	/AD26	Address/Data 26
20	/AD28	Address/Data 28
21	/AD30	Address/Data 30
22	GND	Ground
23	/PFW	
24	/ARB0	
25	/ARB2	
26	/ID0	

BETA RELEASE

27	/ID2	
28	/START	
29	+5 V	+5 VDC
30	+5 V	+5 VDC
31	GND	Ground
32	/CLK	Clock

Contributor: Joakim Ögren <qtech@mailhost.net>, Karsten Wenke <Karsten.Wenke@t-online.de>, Michael Van den Acker <rdsmv@huntsman.cse.rmit.edu.au>

Source: ?

Please send any comments to Joakim Ögren <qtech@mailhost.net>.

PRELIMINARY BETA. NOT FOR REDISTRIBUTION.

NuBus 90

Available on old Apple Macintosh computers.

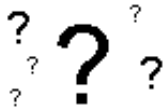

(At the card)

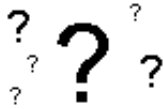

(At the computer)

UNKNOWN CONNECTOR at the card.

UNKNOWN CONNECTOR at the computer.

Row A

Pin Name	Description
1	-12 V -12 VDC
2	SB0
3	/SPV
4	/SP
5	/TM1
6	/AD1 Address/Data 1
7	/AD3 Address/Data 3
8	/AD5 Address/Data 5
9	/AD7 Address/Data 7
10	/AD9 Address/Data 9
11	/AD11 Address/Data 11
12	/AD13 Address/Data 13
13	/AD15 Address/Data 15
14	/AD17 Address/Data 17
15	/AD19 Address/Data 19
16	/AD21 Address/Data 21
17	/AD23 Address/Data 23
18	/AD25 Address/Data 25
19	/AD27 Address/Data 27
20	/AD29 Address/Data 29
21	/AD31 Address/Data 31
22	GND Ground
23	GND Ground
24	/ARB1
25	/ARB3
26	/ID1
27	/ID3
28	/ACK
29	+5 V +5 VDC
30	/RQST
31	/NMRQ
32	+12 V +12 VDC

Row B

Pin Name	Description
1	-12 V -12 VDC
2	GND Ground
3	GND Ground

BETA RELEASE

4	+5 V	+5 VDC
5	+5 V	+5 VDC
6	+5 V	+5 VDC
7	+5 V	+5 VDC
8	/TM2	
9	/CM0	
10	/CM1	
11	/CM2	
12	GND	Ground
13	GND	Ground
14	GND	Ground
15	GND	Ground
16	GND	Ground
17	GND	Ground
18	GND	Ground
19	GND	Ground
20	GND	Ground
21	GND	Ground
22	GND	Ground
23	GND	Ground
24	/CLK2X	
25	STDBYPWR	
26	/CLK2XEN	
27	/CBUSY	
28	+5 V	+5 VDC
29	+5 V	+5 VDC
30	GND	Ground
31	GND	Ground
32	+12 V	+12 VDC

Row C

Pin	Name	Description
1	/RESET	Reset
2	SB1	
3	+5 V	+5 VDC
4	+5 V	+5 VDC
5	/TM0	
6	/AD0	Address/Data 0
7	/AD2	Address/Data 2
8	/AD4	Address/Data 4
9	/AD6	Address/Data 6
10	/AD8	Address/Data 8
11	/AD10	Address/Data 10
12	/AD12	Address/Data 12
13	/AD14	Address/Data 14
14	/AD16	Address/Data 16
15	/AD18	Address/Data 18
16	/AD20	Address/Data 20
17	/AD22	Address/Data 22
18	/AD24	Address/Data 24
19	/AD26	Address/Data 26
20	/AD28	Address/Data 28
21	/AD30	Address/Data 30
22	GND	Ground
23	/PFW	
24	/ARB0	
25	/ARB2	
26	/ID0	
27	/ID2	

BETA RELEASE

28	/START	
29	+5 V	+5 VDC
30	+5 V	+5 VDC
31	GND	Ground
32	/CLK	Clock

Contributor: Joakim Ögren <qtech@mailhost.net>, Karsten Wenke <Karsten.Wenke@t-online.de>

Source: ?

Please send any comments to Joakim Ögren <qtech@mailhost.net>.

PRELIMINARY BETA. NOT FOR REDISTRIBUTION.

Zorro II

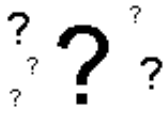

(At the A2000)

86 PIN EDGE CONNECTOR at the A2000.

None: All of my X's suddenly disappeared. I have now put them back again. I hope the table is correct. Please contact me if not. I don't remember where I found this information.

Pin	A500	A1000	A2000	A2000B	Name	Description
1	X	X	X	X	GND	Ground
2	X	X	X	X	GND	Ground
3	X	X	X	X	GND	Ground
4	X	X	X	X	GND	Ground
5	X	X	X	X	+5V	+5 Volts DC
6	X	X	X	X	+5V	+5 Volts DC
7	X	X	X	X	n/c	
8	X	X	X	X	-5V	-5 Volts DC
9	X	X			n/c	
			X	X	28CLOCK	28MHz Clock
10	X	X	X	X	+12V	+12 Volts DC
11	X	X			n/c	
			X	X	/COPCFG	Configuration Out
12	X	X	X	X	CONFIG IN, Grounded	
13	X	X	X	X	GND	Ground
14	X	X	X	X	/C3	C3 Clock
15	X	X	X	X	CDAC	Clock
16	X	X	X	X	/C1	C1 Clock
17	X	X	X	X	/OVR	
18	X	X	X	X	RDY	Ready
19	X	X	X	X	/INT2	Interrupt 2
20	X	X			/PALOPE	
			X		n/c	
				X	/BOSS	
21	X	X	X	X	A5	Address 5
22	X	X	X	X	/INT6	Interrupt 6
23	X	X	X	X	A6	Address 6
24	X	X	X	X	A4	Address 4
25	X	X	X	X	GND	Ground
26	X	X	X	X	A3	Address 3
27	X	X	X	X	A2	Address 2
28	X	X	X	X	A7	Address 7
29	X	X	X	X	A1	Address 1
30	X	X	X	X	A8	Address 8
31	X	X	X	X	FC0	Processor status 0
32	X	X	X	X	A9	Address 9
33	X	X	X	X	FC1	Processor status 1
34	X	X	X	X	A10	Address 10
35	X	X	X	X	FC2	Processor status 2
36	X	X	X	X	A11	Address 11
37	X	X	X	X	GND	Ground
38	X	X	X	X	A12	Address 12
39	X	X	X	X	A13	Address 13
40	X	X	X	X	/IPL0	
41	X	X	X	X	A14	Address 14
42	X	X	X	X	/IPL1	

BETA RELEASE

43	X	X	X	X	A15	Address 15
44	X	X	X	X	/IPL2	
45	X	X	X	X	A16	Address 16
46	X	X	X	X	/BEER	Bus Error
47	X	X	X	X	A17	Address
48	X	X	X	X	/VPA	
49	X	X	X	X	GND	Ground
50	X	X	X	X	ECLK	E Clock
51	X	X	X	X	/VMA	
52	X	X	X	X	A18	Address 18
53	X	X	X	X	RST	Reset
54	X	X	X	X	A19	Address 19
55	X	X	X	X	/HLT	Halt
56	X	X	X	X	A20	Address 20
57	X	X	X	X	A22	Address 22
58	X	X	X	X	A21	Address 21
59	X	X	X	X	A23	Address 23
60	X	X			/BR	
			X	X	/CBR	
61	X	X	X	X	GND	Ground
62	X	X	X	X	/BGACK	
63	X	X	X	X	D15	Data 15
64	X	X			/BG	
			X	X	/CBG	
65	X	X	X	X	D14	Data 14
66	X	X	X	X	/DTACK	
67	X	X	X	X	D13	Data 13
68	X	X	X	X	R/W	Read/Write
69	X	X	X	X	D12	Data 12
70	X	X	X	X	/LDS	
71	X	X	X	X	D11	Data 11
72	X	X	X	X	/UDS	
73	X	X	X	X	GND	Ground
74	X	X	X	X	/AS	
75	X	X	X	X	D0	Data 0
76	X	X	X	X	D10	Data 10
77	X	X	X	X	D1	Data 1
78	X	X	X	X	D9	Data 9
79	X	X	X	X	D2	Data 2
80	X	X	X	X	D8	Data 8
81	X	X	X	X	D3	Data 3
82	X	X	X	X	D7	Data 7
83	X	X	X	X	D4	Data 4
84	X	X	X	X	D6	Data 6
85	X	X	X	X	GND	Ground
86	X	X	X	X	D5	Data 5

Contributor: Joakim Ögren <qtech@mailhost.net>

Source: ?

Please send any comments to Joakim Ögren <qtech@mailhost.net>.

Zorro II/III

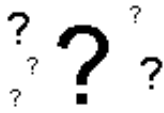

(At the computer)

100 PIN EDGE CONNECTOR at the computer.

Pin	Physical Name	Zorro II Name	Zorro III Address Phase	Zorro III Data Phase
1	Ground	Ground	Ground	Ground
2	Ground	Ground	Ground	Ground
3	Ground	Ground	Ground	Ground
4	Ground	Ground	Ground	Ground
5	+5VDC	+5VDC	+5VDC	+5VDC
6	+5VDC	+5VDC	+5VDC	+5VDC
7	/OWN	/OWN	/OWN	/OWN
8	-5VDC	-5VDC	-5VDC	-5VDC
9	/SLAVEn	/SLAVEn	/SLAVEn	/SLAVEn
10	+12VDC	+12VDC	+12VDC	+12VDC
11	/CFGOUTn	/CFGOUTn	/CFGOUTn	/CFGOUTn
12	/CFGInn	/CFGInn	/CFGInn	/CFGInn
13	Ground	Ground	Ground	Ground
14	/C3	/C3 Clock	/C3 Clock	/C3 Clock
15	CDAC	CDAC Clock	CDAC Clock	CDAC Clock
16	/C1	/C1 Clock	/C1 Clock	/C1 Clock
17	/CINH	/OVR	/CINH	/CINH
18	/MTCR	XRDY	/MTCR	/MTCR
19	/INT2	/INT2	/INT2	/INT2
20	-12VDC	-12VDC	-12VDC	-12VDC
21	A5	A5	A5	A5
22	/INT6	/INT6	/INT6	/INT6
23	A6	A6	A6	A6
24	A4	A4	A4	A4
25	Ground	Ground	Ground	Ground
26	A3	A3	A3	A3
27	A2	A2	A2	A2
28	A7	A7	A7	A7
29	/LOCK	A1	/LOCK	/LOCK
30	AD8	A8	A8	D0
31	FC0	FC0	FC0	FC0
32	AD9	A9	A9	D1
33	FC1	FC1	FC1	FC1
34	AD10	A10	A10	D2
35	FC2	FC2	FC2	FC2
36	AD11	A11	A11	D3
37	Ground	Ground	Ground	Ground
38	AD12	A12	A12	D4
39	AD13	A13	A13	D5
40	Reserved	(/EINT7)	Reserved	Reserved
41	AD14	A14	A14	D6
42	Reserved	(/EINT5)	Reserved	Reserved
43	AD15	A15	A15	D7
44	Reserved	(/EINT4)	Reserved	Reserved
45	AD16	A16	A16	D8

BETA RELEASE

46	/BERR	/BERR	/BERR	/BERR
47	AD17	A17	A17	D9
48	/MTACK	(/VPA)	/MTACK	/MTACK
49	Ground	Ground	Ground	Ground
50	E Clock	E Clock	E Clock	E Clock
51	/DS0	(/VMA)	/DS0	/DS0
52	AD18	A18	A18	D10
53	/RESET	/RST	/RESET	/RESET
54	AD19	A19	A19	D11
55	/HLT	/HLT	/HLT	/HLT
56	AD20	A20	A20	D12
57	AD22	A22	A22	D14
58	AD21	A21	A21	D13
59	AD23	A23	A23	D15
60	/BRn	/BRn	/BRn	/BRn
61	Ground	Ground	Ground	Ground
62	/BGACK	/BGACK	/BGACK	/BGACK
63	AD31	D15	A31	D31
64	/BGn	/BGn	/BGn	/BGn
65	AD30	D14	A30	D30
66	/DTACK	/DTACK	/DTACK	/DTACK
67	AD29	D13	A29	D29
68	READ	READ	READ	READ
69	AD28	D12	A28	D28
70	/DS2	/LDS	/DS2	/DS2
71	AD27	D11	A27	D27
72	/DS3	/UDS	/DS3	/DS3
73	Ground	Ground	Ground	Ground
74	/CCS	/AS	/CCS	/CCS
75	SD0	D0	Reserved	D16
76	AD26	D10	A26	D26
77	SD1	D1	Reserved	D17
78	AD25	D9	A25	D25
79	SD2	D2	Reserved	D18
80	AD24	D8	A24	D24
81	SD3	D3	Reserved	D19
82	SD7	D7	Reserved	D23
83	SD4	D4	Reserved	D20
84	SD6	D6	Reserved	D22
85	Ground	Ground	Ground	Ground
86	SD5	D5	Reserved	D21
87	Ground	Ground	Ground	Ground
88	Ground	Ground	Ground	Ground
89	Ground	Ground	Ground	Ground
90	Ground	Ground	Ground	Ground
91	SenseZ3	Ground	SenseZ3	SenseZ3
92	7M	E7M	7M	7M
93	DOE	DOE	DOE	DOE
94	/IORST	/BUSRST	/IORST	/IORST
95	/BCLR	/GBG	/BCLR	/BCLR
96	Reserved	(/EINT1)	Reserved	Reserved
97	/FCS	No Connect	/FCS	/FCS
98	/DS1	No Connect	/DS1	/DS1
99	Ground	Ground	Ground	Ground
100	Ground	Ground	Ground	Ground

Contributor: Joakim Ögren <qtech@mailhost.net>

Source: Amiga 4000 User's Guide from Commodore

Please send any comments to Joakim Ögren <qtech@mailhost.net>.

BETA RELEASE

Amiga 1200 CPU-port

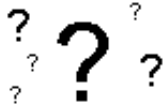

(At the computer)

UNKNOWN CONNECTOR at the computer.

Pin	Name	Description
1	n/c	Reserved
2	n/c	Reserved
3	n/c	Reserved
4	n/c	Reserved
5	n/c	Reserved
6	n/c	Reserved
7	n/c	Reserved
8	n/c	Reserved
9	GND	Ground
10	+5V	+5 Volts DC
11	A23	Address 23
12	A22	Address 22
13	A21	Address 21
14	A20	Address 20
15	A19	Address 19
16	A18	Address 18
17	A17	Address 17
18	A16	Address 16
19	GND	Ground
20	+5V	+5 Volts DC
21	A15	Address 15
22	A14	Address 14
23	A13	Address 13
24	A12	Address 12
25	A11	Address 11
26	A10	Address 10
27	A9	Address 9
28	A8	Address 8
29	GND	Ground
30	+5V	+5 Volts DC
31	A7	Address 7
32	A6	Address 6
33	A5	Address 5
34	A4	Address 4
35	A3	Address 3
36	A2	Address 2
37	A1	Address 1
38	A0	Address 0
39	GND	Ground
40	+5V	+5 Volts DC
41	D31	Data 31
42	D30	Data 30
43	D29	Data 29
44	D28	Data 28
45	D27	Data 27
46	D26	Data 26
47	D25	Data 25
48	D24	Data 24
49	GND	Ground

BETA RELEASE

50	+5V	+5 Volts DC
51	D23	Data 23
52	D22	Data 22
53	D21	Data 21
54	D20	Data 20
55	D19	Data 19
56	D18	Data 18
57	D17	Data 17
58	D16	Data 16
59	GND	Ground
60	+5V	+5 Volts DC
61	D15	Data 15
62	D14	Data 14
63	D13	Data 13
64	D12	Data 12
65	D11	Data 11
66	D10	Data 10
67	D9	Data 9
68	D8	Data 8
69	GND	Ground
70	+5V	+5 Volts DC
71	D7	Data 7
72	D6	Data 6
73	D5	Data 5
74	D4	Data 4
75	D3	Data 3
76	D2	Data 2
77	D1	Data 1
78	D0	Data 0
79	GND	Ground
80	+5V	+5 Volts DC
81	/IPL2	
82	/IPL1	
83	/IPL0	
84	n/c	Reserved
85	/RST	Reset
86	/HLT	Halt
87	n/c	Reserved
88	n/c	Reserved
89	SIZE1	
90	SIZE0	
91	/AS	Address Strobe
92	/DS	Data Strobe
93	R/W	Read/Write
94	/BERR	Bus Error
95	n/c	Reserved
96	/AVEC	
97	/DSACK1	
98	/DSACK2	
99	CPUCKLA	
100	ECLOCK	EClock pulse
101	GND	Ground
102	+5V	+5 Volts DC
103	FC2	Processor Status 2
104	FC1	Processor Status 1
105	FC0	Processor Status 0
106	/RMC	
107	n/c	Reserved
108	n/c	Reserved
109	n/c	Reserved

BETA RELEASE

110	n/c	Reserved
111	/BR	Slot specific Bus Arbitration
112	/BG	Slot specific Bus Arbitration
113	n/c	Reserved
114	/BOSS	
115	/FPUCS	FPU Chip select
116	/FPUSENSE	FPU Sense
117	CCKA	
118	/RESET	Reset
119	GND	Ground
120	+5V	+5 Volts DC
121	/NETCS	
122	/SPARECS	
123	/RTCCS	Realtime Clock Chip select
124	/FLASH	
125	/REG	
126	/CCENA	
127	/WAIT	
128	/KBRESET	Keyboard reset
129	/IORD	IO Read
130	/IOWR	IO Write
131	/OE	Output enable
132	/WE	
133	/OVR	/DTACK Override
134	XRDY	External Ready
135	/ZORRO	
136	/WIDE	
137	/INT2	Interrupt level 2
138	/INT6	Interrupt level 6
139	GND	Ground
140	+5V	+5 Volts DC
141	SYSTEM1	System1 Ground
142	SYSTEM0	System0 Ground
143	/xRxD	
144	/xTxD	
145	/CONFIG OUT	
146	AGND	Audio Ground
147	ALEFT	Audio Left
148	ARIGHT	Audio Right
149	+12V	+12 Volts DC
150	-12V	-12 Volts DC

Contributor: Joakim Ögren <qtech@mailhost.net>

Source: ?

Please send any comments to Joakim Ögren <qtech@mailhost.net>.

Amiga 1000 Ramex

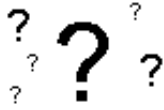

(At the computer)

60 PIN EDGE CONNECTOR (.156") at the computer.

Pin Name	Description
1	GND Ground
2	D15 Data 15
3	+5V +5 Volts DC
4	D12 Data 12
5	GND Ground
6	D11 Data 11
7	+5V +5 Volts DC
8	D8 Data 8
9	GND Ground
10	D7 Data 7
11	+5V +5 Volts DC
12	D4 Data 4
13	GND Ground
14	D3 Data 3
15	+5V +5 Volts DC
16	D0 Data 0
17	GND Ground
18	DRA4
19	DRA5
20	DRA6
21	DRA7
22	GND Ground
23	/RAS
24	GND Ground
25	GND Ground
26	/CASU0
27	GND Ground
28	/CASL0
29	+5V +5 Volts DC
30	+5V +5 Volts DC
A	GND Ground
B	D14 Data 14
C	+5V +5 Volts DC
D	D13 Data 13
E	GND Ground
F	D10 Data 10
H	+5V +5 Volts DC
J	D9 Data 9
K	GND Ground
L	D6 Data 6
M	+5V +5 Volts DC
N	D5 Data 5
P	GND Ground
R	D2 Data 2
S	+5V +5 Volts DC
T	D1 Data 1
U	GND Ground
V	DRA3

BETA RELEASE

W DRA2
X DRA1
Y DRA0
Z GND Ground
AA /RRW
BB GND Ground
CC GND Ground
DD /CASU1
EE GND Ground
FF /CASL1
HH +5V +5 Volts DC
JJ +5V +5 Volts DC

Contributor: Joakim Ögren <qtech@mailhost.net>

Source: ?

Please send any comments to Joakim Ögren <qtech@mailhost.net>.

PRELIMINARY BETA. NOT FOR REDISTRIBUTION.

Video Expansion (Amiga)

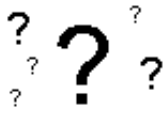

(At the computer)

36+54 PIN EDGE CONNECTOR at the computer.

Pin	Name	Dir	Description
1	RGB16	→	Red Bit 0
2	RGB17	→	Red Bit 1
3	LINELF	→	Audio Line Out Left
4	LINERT	→	Audio Line Out Right
5	C28D	→	Pixel-Synchronous Clock
6	+5V	-	+5 Volts DC (1 A)
7	ARED	→	Analog Red
8	+5V	-	+5 Volts DC (1 A)
9	GND	-	Digital Ground
10	+12V	-	+12 Volts DC (40 mA)
11	AGREEN	→	Analog Green
12	GND	-	Digital Ground
13	GND	-	Digital Ground
14	/CSYNC	→	Composite Sync
15	ABLUE	→	Analog Blue
16	/XCLKEN	←	Genlock Clock Enable
17	GND	-	Digital Ground
18	BURST	→	Burst Gate
19	/C4	→	3.55/3.58 MHz Clock
20	GND	-	Digital Ground
21	GND	-	Digital Ground
22	/HSYNC	→	Horizontal Sync (47 Ohm)
23	RGB4	→	Blue Bit 4
24	GND	-	Digital Ground
25	RGB7	→	Blue Bit 7
26	/VSYNC	→	Vertical Sync (47 Ohm)
27	RGB15	→	Green Bit 7
28	BLANK	→	Video Blank
29	RGB23	→	Red 7
30	/PIXELSW	→	Genlock Overlay (47 Ohm)
31	-5V	-	-5 Volts DC
32	GND	-	Digital Ground
33	/XCLK	←	Genlock Clock
34	/C1	→	C1 Clock
35	+5V	-	+5 Volts DC (1 A)
36	PSTROBE	→	Printer Port Handshake
1	GND	-	Digital Ground
2	RGB20	→	Red Bit 4
3	RGB21	→	Red Bit 5
4	RGB22	→	Red Bit 6
5	GND	-	Digital Ground
6	RGB12	→	Green Bit 4
7	RGB13	→	Green Bit 5
8	RGB14	→	Green Bit 6
9	GND	-	Digital Ground
10	RGB5	→	Blue Bit 5
11	RGB6	→	Blue Bit 6
12	GND	-	Ground

BETA RELEASE

13	SOG	→	Sync-On-Green Indicator
14	TBASE	↔	50/60 Hz Software Clock Timebase
15	CDAC	↔	7.09/7.16 MHz Clock
16	PPOUT	↔	Printer Port Paper Out
17	/C3	↔	3.55/3.58 MHz Clock
18	PBUSY	↔	Printer Port Busy
19	/LPEN	↑	Light Pen Input
20	/PACK	↔	Printer Port Acknowledge Handshake
21	PSEL	↓	Printer Port Select
22	GND	-	Digital Ground
23	PPD0	↔	Printer Port Data Bit 0
24	PPD1	↔	Printer Port Data Bit 1
25	PPD2	↔	Printer Port Data Bit 2
26	PPD3	↔	Printer Port Data Bit 3
27	PPD4	↔	Printer Port Data Bit 4
28	PPD5	↔	Printer Port Data Bit 5
29	PPD6	↔	Printer Port Data Bit 6
30	PPD7	↔	Printer Port Data Bit 7
31	/LED	↓	LED (Audio filter bypass) Setting
32	GND	-	Digital Ground
33	RAWLF	→	Raw (Unfiltered) Audio Left
34	AGND	-	Audio Ground
35	RAWRT	→	Raw (Unfiltered) Audio Right
36	AGND	-	Audio Ground
37	n/c	-	Reserved for future expansion
38	n/c	-	Reserved for future expansion
39	GND	-	Digital Ground
40	GND	-	Digital Ground
41	n/c	-	Reserved for future expansion
42	n/c	-	Reserved for future expansion
43	GND	-	Digital Ground
44	GND	-	Digital Ground
45	RGB18	→	Red Bit 2
46	RGB19	→	Red Bit 3
47	RGB8	→	Green Bit 0
48	RGB9	→	Green Bit 1
49	RGB10	→	Green Bit 2
50	RGB11	→	Green Bit 3
51	RGB0	→	Blue Bit 0
52	RGB1	→	Blue Bit 1
53	RGB2	→	Blue Bit 2
54	RGB3	→	Blue Bit 3

Note: Direction is Motherboard relative Card.

Note: Do not mix analog & digital grounds.

Contributor: Joakim Ögren <qtech@mailhost.net>

Source: Amiga 4000 User's Guide from Commodore

Please send any comments to Joakim Ögren <qtech@mailhost.net>.

CD32 Expansion-port

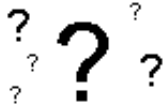

(At the computer)

UNKNOWN 182 PIN CONNECTOR (SAME AS MCA) at the computer.

Pin	Name	Description	Comment
1	A31	Address 31	Probably not connected since 68EC020
2	A30	Address 30	Probably not connected since 68EC020
3	A29	Address 29	Probably not connected since 68EC020
4	A28	Address 28	Probably not connected since 68EC020
5	A27	Address 27	Probably not connected since 68EC020
6	A26	Address 26	Probably not connected since 68EC020
7	A25	Address 25	Probably not connected since 68EC020
8	A24	Address 24	Probably not connected since 68EC020
9	DGND	Data Ground	
10	VCC	+5 VDC	
11	A23	Address 23	
12	A22	Address 22	
13	A21	Address 21	
14	A20	Address 20	
15	A19	Address 19	
16	A18	Address 18	
17	A17	Address 17	
18	A16	Address 16	
19	DGND	Data Ground	
20	VCC	+5 VDC	
21	A15	Address 15	
22	A14	Address 14	
23	A13	Address 13	
24	A12	Address 12	
25	A11	Address 11	
26	A10	Address 10	
27	A9	Address 9	
28	A8	Address 8	
29	DGND	Data Ground	
30	VCC	+5 VDC	
31	A7	Address 7	
32	A6	Address 6	
33	A5	Address 5	
34	A4	Address 4	
35	A3	Address 3	
36	A2	Address 2	
37	A1	Address 1	
38	A0	Address 0	
39	DGND	Data Ground	
40	VCC	+5 VDC	
41	D31	Data 31	
42	D30	Data 30	
43	D29	Data 29	
44	D28	Data 28	
45	D27	Data 27	
46	D26	Data 26	
47	D25	Data 25	
48	D24	Data 24	
49	DGND	Data Ground	

BETA RELEASE

50	VCC	+5 VDC	
51	D23	Data 23	
52	D22	Data 22	
53	D21	Data 21	
54	D20	Data 20	
55	D19	Data 19	
56	D18	Data 18	
57	D17	Data 17	
58	D16	Data 16	
59	DGND	Data Ground	
60	VCC	+5 VDC	
61	D15	Data 15	
62	D14	Data 14	
63	D13	Data 13	
64	D12	Data 12	
65	D11	Data 11	
66	D10	Data 10	
67	D9	Data 9	
68	D8	Data 8	
69	DGND	Data Ground	
70	VCC	+5 VDC	
71	D7	Data 7	
72	D6	Data 6	
73	D5	Data 5	
74	D4	Data 4	
75	D3	Data 3	
76	D2	Data 2	
77	D1	Data 1	
78	D0	Data 0	
79	DGND	Data Ground	
80	VCC	+5 VDC	
81	/IPL2	Interrupt Priority Level 2	
82	/IPL1	Interrupt Priority Level 1	
83	/IPL0	Interrupt Priority Level 0	
84			
85	/RST	Reset	
86	/HALT	Halt	
87	/ECS	ECS??	
88	/OCS	OCS??	
89	SIZE1	Size 1	Indicates number of bytes remaining to transfer
90	SIZE0	Size 0	Indicates number of bytes remaining to transfer
91	/AS	Address Strobe	
92	/DS	Data Strobe	
93	/R/W	Read/Write	
94	/BERR	Bus Error	
95			
96	/AVEC	Autovector Req	Autovector request during interrupt acknowledge
97	/DSACK1	Data Ack 1	Data transfer and size acknowledge
98	/DSACK0	Data Ack 0	Data transfer and size acknowledge
99	CPUCLK_A		
100			
101	DGND	Data Ground	
102	VCC	+5 VDC	
103	FC2	Function Codes 2	
104	FC1	Function Codes 1	
105	FC0	Function Codes 0	
106			

107		
108		
109		
110		
111	/CPU_BR	CPU bus request??
112	/EXP_BG	Expansion bus granted??
113	/CPU_BG	CPU bus granted??
114	/EXP_BR	Expansion bus request??
115		
116		
117	/PUNT	
118	/RESET	68020 RESET
119	/INT2	Interrupt 2 Generate a level 2 interrupt
120	/INT6	Interrupt 2 Generate a level 6 interrupt
121	/KB_CLOCK	Keyboard clock
122	/KB_DATA	Keyboard data
123	/FIRE0	Fire Button 0??
124	/FIRE1	Fire Button 1??
125	/LED	Power On LED ??
126	/ACTIVE	Disk active LED
127	/RXD	Serial Receive Serial data in
128	/TXD	Serial Transmit Serial data out
129	/DKRD	Floppy interface (Paula?)
130	/DKWD	Floppy interface (Paula?)
131	SYSTEM	
132	/DKWE	Floppy interface (Paula?)
133	CONFIG_OUT	
134		
135	DGND	Data Ground
136	+12V	+12V DC
137	DGND	Data Ground
138	+12V	+12V DC
139	17MHZ	For FMV inteface ??
140	EXT_AUDIO	For FMV inteface ??
141	DA_DATA	For FMV inteface ??
142	/MUTE	For FMV inteface ??
143	DA_LRCLK	For FMV inteface ??
144	DA_BCLK	For FMV inteface ??
145	DGND	Data Ground
146	VCC	+5 VDC
147	DR	Digital Red
148	DG	Digital Green
149	DB	Digital Blue
150	DI	Digital Intensity
151	/PIXELSW_EXT	
152	/PIXELSW	
153	/BLANK	
154	PIXELCLK	Pixelclock For manipulating RBG data
155	DGND	Data Ground
156	VCC	+5 VDC
157	/CSYNC	Composite sync Not buffered.
158	CCK_B	Color clock ??
159	/HSYNC	Horizontal sync
160	/VSYNC	Vertical sync
161	VGND	Video ground
162	VGND	Video ground
163	AR_EXT	Analog Red External
164	AR	Analog Red
165	AG_EXT	Analog Green External
166	AG	Analog Green

BETA RELEASE

167	AB_EXT	Analog Blue External
168	AB	Analog Blue
169	VGND	Video ground
170	VGND	Video ground
171	/NTSC	
172	/XCLKEN	Enable External video clock (Genlock)
173	XCLK	External video clock (Genlock)
174	/EXT_VIDEO	External Video Disable internal video interfaces
175	DGND	Data Ground
176	VCC	+5 VDC
177	AGND	Audio Ground
178	+12V	+12V DC
179	LEFT_EXT	Left sound External
180	LEFT	Left sound
181	RIGHT_EXT	Right sound External
182	RIGHT	Right sound

Contributor: Joakim Ögren <qtech@mailhost.net>

Source: CD32 expansion port info <ftp://ftp.demon.co.uk/pub/amiga/docs/cd32-pinouts.txt>, usenet posting by Anders Stenkvisst <ask_me@elixir.e.kth.se>.

Please send any comments to Joakim Ögren <qtech@mailhost.net>.

CardBus

32-bit bus defined by PCMCIA.

NOT

DRAWN

YET...



(At the controller)

NOT

DRAWN

YET...



(At the peripherals)

68 PIN ??? MALE at the controller.

68 PIN ??? FEMALE at the peripherals.

Pin Name	Description
1 GND	Ground
2 CAD0	Address/Data 0
3 CAD1	Address/Data 1
4 CAD3	Address/Data 3
5 CAD5	Address/Data 5
6 CAD7	Address/Data 7
7 CCBE0#	Command/Byte Enable 0
8 CAD9	Address/Data 9
9 CAD11	Address/Data 11
10 CAD12	Address/Data 12
11 CAD14	Address/Data 14
12 CCBE1#	Command/Byte Enable 1
13 CPAR	Parity
14 CPERR#	Parity error
15 CGNT#	Grant
16 CINT#	Interrupt
17 Vcc	Vcc
18 Vpp1	Vpp1
19 CCLK	CCLK
20 CIRDY#	Initiator Ready
21 CCBE2#	Command/Byte Enable 2
22 CAD18	Address/Data 18
23 CAD20	Address/Data 20
24 CAD21	Address/Data 21
25 CAD22	Address/Data 22
26 CAD23	Address/Data 23
27 CAD24	Address/Data 24
28 CAD25	Address/Data 25
29 CAD26	Address/Data 26
30 CAD27	Address/Data 27
31 CAD29	Address/Data 29
32 RSRVD	Reserved
33 CCLKRUN#	CCLKRUN#
34 GND	Ground
35 GND	Ground
36 CCD1#	Card Detect 1
37 CAD2	Address/Data 2
38 CAD4	Address/Data 4
39 CAD6	Address/Data 6
40 RSRVD	Reserved
41 CAD8	Address/Data 8
42 CAD10	Address/Data 10

BETA RELEASE

43	CVS1	
44	CAD13	Address/Data 13
45	CAD15	Address/Data 15
46	CAD16	Address/Data 16
47	RSRVD	Reserved
48	CBLOCK#	Block ???
49	CSTOP#	Stop transfer cycle
50	CDEVSEL#	Device Select
51	Vcc	Vcc
52	Vpp2	Vpp2
53	CTRDY#	Target Ready
54	CFRAME#	Address or Data phase
55	CAD17	Address/Data 17
56	CAD19	CAD19
57	CVS2	
58	CRST#	Reset
59	CSERR#	System Error
60	CREQ#	Request ???
61	CCBE3#	Command/Byte Enable 3
62	CAUDIO	Audio ???
63	CSTSCHG	
64	CAD28	Address/Data 28
65	CAD30	Address/Data 30
66	CAD31	Address/Data 31
67	CCD2#	Card Detect 2
68	GND	Ground

Contributor: Joakim Ögren <qtech@mailhost.net>

Source: PC Card Standard <http://www.pc-card.com/stand_overview.html> at PC Card's homepage
<<http://www.pc-card.com>>

Please send any comments to Joakim Ögren <qtech@mailhost.net>

PC Card

16-bit bus defined by PCMCIA.

NOT

DRAWN

YET...



(At the controller)

NOT

DRAWN

YET...



(At the peripherals)

68 PIN ??? MALE at the controller.

68 PIN ??? FEMALE at the peripherals.

Pin	Memory	I/O+Mem	Description
1	GND	GND	Ground
2	D3	D3	Data 3
3	D4	D4	Data 4
4	D5	D5	Data 5
5	D6	D6	Data 6
6	D7	D7	Data 7
7	CE1#	CE1#	
8	A10	A10	Address 10
9	OE#	OE#	Output Enable
10	A11	A11	Address 11
11	A9	A9	Address 9
12	A8	A8	Address 8
13	A13	A13	Address 13
14	A14	A14	Address 14
15	WE#	WE#	Write Enable ???
16	READY	IREQ#	
17	Vcc	Vcc	Vcc
18	Vpp1	Vpp1	Vpp1
19	A16	A16	Address 16
20	A15	A15	Address 15
21	A12	A12	Address 12
22	A7	A7	Address 7
23	A6	A6	Address 6
24	A5	A5	Address 5
25	A4	A4	Address 4
26	A3	A3	Address 3
27	A2	A2	Address 2
28	A1	A1	Address 1
29	A0	A0	Address 0
30	D0	D0	Data 0
31	D1	D1	Data 1
32	D2	D2	Data 2
33	WP	IOIS16#	
34	GND	GND	Ground
35	GND	GND	Ground
36	CD1#	CD1#	Card Detect 1
37	D11	D11	Data 11
38	D12	D12	Data 12
39	D13	D13	Data 13
40	D14	D14	Data 14
41	D15	D15	Data 15
42	CE2#	CE2#	

BETA RELEASE

43	VS1#	VS1#	
44	RSRVD	IORD#	Reserved / IORD#
45	RSRVD	IOWR#	Reserved / IOWR#
46	A17	A17	Address 17
47	A18	A18	Address 18
48	A19	A19	Address 19
49	A20	A20	Address 20
50	A21	A21	Address 21
51	Vcc	Vcc	Vcc
52	Vpp2	Vpp2	Vpp2
53	A22	A22	Address 22
54	A23	A23	Address 23
55	A24	A24	Address 24
56	A25	A25	Address 25
57	VS2#	VS2#	
58	RESET	RESET	Reset
59	WAIT#	WAIT#	
60	RSRVD	INPACK#	Reserved / ???
61	REG#	REG#	
62	BVD2	SPKR#	Battery Voltage 2 / Speaker ???
63	BVD1	STSCHG#	Battery Voltage 1 / ???
64	D8	D8	Data 8
65	D9	D9	Data 9
66	D10	D10	Data 10
67	CD2#	CD2#	
68	GND	GND	Ground

Contributor: Joakim Ögren <qtech@mailhost.net>

Source: PC Card Standard <http://www.pc-card.com/stand_overview.html> at PC Card's homepage
<<http://www.pc-card.com>>

Please send any comments to Joakim Ögren <qtech@mailhost.net>.

PC Card ATA

This specification makes it possible to share ATA & PC Card with the same connectors.

NOT**DRAWN****YET...**

(At the controller)

NOT**DRAWN****YET...**



















(At the peripherals)

68 PIN ??? MALE at the controller.

68 PIN ??? FEMALE at the peripherals.

Pin	Name	Host	Dir	Dev	PC-Card equiv
1	Ground	x	↓	x	Ground
2	DD3	x	↕	x	D3
3	DD4	x	↕	x	D4
4	DD5	x	↕	x	D5
5	DD6	x	↕	x	D6
6	DD7	x	↕	x	D7
7	/CS0	x	↓	x	/CE1
8			↓	i	A10
9	/SELATA	x	↓	x	/OE
10					
11	/CS1	x	↓	x 1)	A9
12			↓	i	A8
13					
14					
15			↓	i	/WE
16	INTRQ	x	↑	x	/READY:IREQ
17	VCC	x	↓	x	VCC
18					
19					
20					
21					
22			↓	i	A7
23			↓	i	A6
24			↓	i	A5
25			↓	i	A4
26			↓	i	A3
27	DA2	x	↓	x	A2
28	DA1	x	↓	x	A1
29	DA0	x	↓	x	A0
30	DD0	x	↕	x	D0
31	DD1	x	↕	x	D1
32	DD2	x	↕	x	D2
33	/IOCS16	x	↑	x	/WP:IOIS16
34	Ground	x	↓	x	Ground
35	Ground	x	↓	x	Ground
36	/CD1	x	↑	x	/CD1
37	DD11	x	↕	x	D11
38	DD12	x	↕	x	D12
39	DD13	x	↕	x	D13
40	DD14	x	↕	x	D14
41	DD15	x	↕	x	D15
42	/CS1	x	↓	x 1)	/CE2

BETA RELEASE

43				i	/VS1
44	/DIOR	x		x	/IORD
45	/DIOW	x		x	/IOWR
46					
47					
48					
49					
50					
51	VCC	x		x	VCC
52					
53					
54					
55	M/S-	x		x 2)	
56	CSEL	x		x 2)	
57				i	/VS2
58	/RESET	x		x	RESET
59	IORDY	o		x 3)	/WAIT
60	DMARQ	o		x 3)	/INPACK
61	/DMACK	o		o	/REG
62	/DASP	x		x	/BVD2:SPKR
63	/PDIAG	x		x	/BVD1:STSCHG
64	DD8	x		x	D8
65	DD9	x		x	D9
66	DD10	x		x	D10
67	/CD2	x		x	/CD2
68	Ground	x		x	Ground

x = Required.

i = Ignored by host in ATA mode.

o = Optional.

nothing = Not connected.

1) Device shall support only one /CS1 signal pin.

2) Device shall support either /M/S or CSEL but not both.

3) Device shall hold this signal negated if it does not support this function.

Contributor: Joakim Ögren <qtech@mailhost.net>

Source: ATA-2 specifications

Please send any comments to Joakim Ögren <qtech@mailhost.net>.

PCMCIA

PCMCIA=Personal Computer Memory Card International Association.

NOT

DRAWN

YET...



(At the controller)

NOT

DRAWN

YET...



(At the peripherals)

68 PIN ??? MALE at the controller.

68 PIN ??? FEMALE at the peripherals.

Pin Name	Dir	Description
1 GND	—	Ground
2 D3	↔	Data 3
3 D4	↔	Data 4
4 D5	↔	Data 5
5 D6	↔	Data 6
6 D7	↔	Data 7
7 /CE1	→	Card Enable 1
8 A10	→	Address 10
9 /OE	→	Output Enable
10 A11	→	Address 11
11 A9	→	Address 9
12 A8	→	Address 8
13 A13	→	Address 13
14 A14	→	Address 14
15 /WE:/P	→	Write Enable : Program
16 /READY:/IREQ	←	Ready : Busy (IREQ)
17 VCC	→	+5V
18 VPP1	→	Programming Voltage (EPROM)
19 A16	→	Address 16
20 A15	→	Address 15
21 A12	→	Address 12
22 A7	→	Address 7
23 A6	→	Address 6
24 A5	→	Address 5
25 A4	→	Address 4
26 A3	→	Address 3
27 A2	→	Address 2
28 A1	→	Address 1
29 A0	→	Address 0
30 D0	↔	Data 0
31 D1	↔	Data 1
32 D2	↔	Data 2
33 /WP:/IOIS16	←	Write Protect : IOIS16
34 GND	—	Ground
35 GND	—	Ground
36 /CD1	←	Card Detect 1
37 D11	↔	Data 11
38 D12	↔	Data 12
39 D13	↔	Data 13
40 D14	↔	Data 14
41 D15	↔	Data 15
42 /CE2	→	Card Enable 2

BETA RELEASE

43	/VS1	→	Refresh
44	/IOR	?	I/O Read
45	/IOWR	?	I/O Write
46	A17	→	Address 17
47	A18	→	Address 18
48	A19	→	Address 19
49	A20	→	Address 20
50	A21	→	Address 21
51	VCC	→	+5V
52	VPP2	→	Programmeing Voltage 2 (EPROM)
53	A22	→	Address 22
54	A23	→	Address 23
55	A24	→	Address 24
56	A25	→	Address 25
57	/VS2	?	RFU
58	RESET	?	RESET
59	/WAIT	?	WAIT
60	/INPACK	?	
61	/REG	→	Register Select
62	/BVD2:SPKR	↑	Battery Voltage Detect 2 : SPKR
63	/BVD1:STSCHG	↑	Battery Voltage Detect 1 : STSCHG
64	D8	↔	Data 8
65	D9	↔	Data 9
66	D10	↔	Data 10
67	/CD2	↑	Card Detect 2
68	GND	—	Ground

Note: Direction is Controller (computer) relative PCMCIA-card.

Contributor: Joakim Ögren <qtech@mailhost.net>, Karsten Wenke <Karsten.Wenke@t-online.de>

Source: ?

Please send any comments to Joakim Ögren <qtech@mailhost.net>.

CompactFlash

Developed by SanDisk.

Is compatible with PC-Card ATA with a simple passive adapter.

See PC-Card ATA for more information.

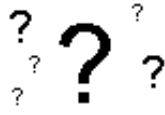

(At the controller)

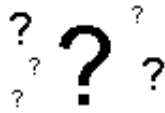

(At the peripherals)

50 PIN ??? MALE at the controller.

50 PIN ??? FEMALE at the peripherals.

Pin Name	Description	
1	GND	Ground
2	D3	Data 3
3	D4	Data 4
4	D5	Data 5
5	D6	Data 6
6	D7	Data 7
7	/CE1	Card Enable 1
8	A10	Address 10
9	/OE	Output Enable
10	A9	Address 9
11	A8	Address 8
12	A7	Address 7
13	VCC	+5V
14	A6	Address 6
15	A5	Address 5
16	A4	Address 4
17	A3	Address 3
18	A2	Address 2
19	A1	Address 1
20	A0	Address 0
21	D0	Data 0
22	D1	Data 1
23	D2	Data 2
24	/WP:/IOIS16	Write Protect : IOIS16
25	/CD2	Card Detect 2
26	/CD1	Card Detect 1
27	D0	Data 0
28	D0	Data 0
29	D0	Data 0
30	D0	Data 0
31	D0	Data 0
32	/CE2	Card Enable 2
33	/VS1	Refresh
34	/IORD	I/O Read
35	/IOWR	I/O Write
36	/WE	Write Enable
37	/READY:/RDY:/IREQ	Ready : Busy : IREQ
38	VCC	+5V
39	CSEL	

BETA RELEASE

40	/VS2	RFU
41	RESET	Reset
42	/WAIT	Wait
43	/INPACK	
44	/REG	Register Select
45	/BVD2:SPKR	Battery Voltage Detect 2 : SPKR
46	/BVD1:STSCHG	Battery Voltage Detect 1 : STSCHG
47	D8	Data 8
48	D9	Data 9
49	D10	Data 10
50	GND	Ground

Contributor: Joakim Ögren <qtech@mailhost.net>

Source: SanDisk's CompactFlash ABC <http://www.sandisk.com/sd/support/teched/cfpc_5.htm> at SanDisk's homepage <<http://www.sandisk.com>>

Please send any comments to Joakim Ögren <qtech@mailhost.net>.

C-bus II

Developed by Corolla

C-bus II is the successor to C-bus & Extended C-bus.

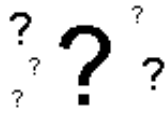

(At the backplane)

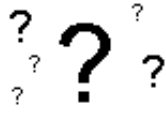

(At the device (card))

UNKNOWN CONNECTOR at the backplane.

UNKNOWN CONNECTOR at the device (card).

PA=Component side

PB=Solder side

Pin	Name
PA1	GND
PA2	AUX18
PA3	AUX16
PA4	GND
PA5	AUX14
PA6	AUX12
PA7	GND
PA8	AUX10
PA9	AUX8
PA10	GND
PA11	AUX6
PA12	AUX4
PA13	GND
PA14	AUX2
PA15	AUX0
PA16	GND
PA17	RESERVED8
PA18	RESERVED6
PA19	RESERVED4
PA20	RESERVED2
PA21	RESERVED0
PA22	GND
PA23	GND
PA24	AGND
PA25	CID1
PA26	CBCLK
PA27	GND
PA28	CRST#
PA29	LED#
PA30	GND
PA31	CARB2
PA32	CARB0
PA33	GND
PA34	TM2#
PA35	TM0#
PA36	GND
PA37	STRT#
PA38	CD31

BETA RELEASE

PA39 GND
PA40 CD30
PA41 CD29
PA42 GND
PA43 CD28
PA44 CD27
PA45 GND
PA46 CD26
PA47 CD25
PA48 GND
PA49 CD24
PA50 CD23
PA51 GND
PA52 CD22
PA53 CD21
PA54 GND
PA55 CD20
PA56 CD19
PA57 GND
PA58 CD18
PA59 CD17
PA60 GND
PA61 CD16
PA62 E3
PA63 GND
PA64 E2
PA65 CD15
PA66 GND
PA67 CD14
PA68 CD13
PA69 GND
PA70 CD12
PA71 CD11
PA72 GND
PA73 CD10
PA74 CD9
PA75 GND
PA76 CD8
PA77 CD7
PA78 GND
PA79 CD6
PA80 CD5
PA81 GND
PA82 CD4
PA83 CD3
PA84 GND
PA85 CD2
PA86 CD1
PA87 GND
PA88 CD0
PA89 E1
PA90 GND
PA91 E0

PB1 +5V
PB2 AUX19
PB3 AUX17
PB4 +5V
PB5 AUX15
PB6 AUX13

BETA RELEASE

PB7	+5V
PB8	AUX11
PB9	AUX9
PB10	+5V
PB11	AUX7
PB12	AUX5
PB13	+5V
PB14	AUX3
PB15	AUX1
PB16	+5V
PB17	RESERVED9
PB18	RESERVED7
PB19	RESERVED5
PB20	RESERVED3
PB21	RESERVED1
PB22	VTERM
PB23	+5V
PB24	CID3
PB25	CID2
PB26	CID0
PB27	+5V
PB28	FAULT#
PB29	LOCKCB#
PB30	+5V
PB31	CARB3
PB32	CARB1
PB33	+5V
PB34	TM3#
PB35	TM1#
PB36	+5V
PB37	ACK#
PB38	CD63
PB39	+5V
PB40	CD62
PB41	CD61
PB42	+5V
PB43	CD60
PB44	CD59
PB45	+5V
PB46	CD58
PB47	CD57
PB48	+5V
PB49	CD56
PB50	CD55
PB51	+3.3V
PB52	CD54
PB53	CD53
PB54	+3.3V
PB55	CD52
PB56	CD51
PB57	+3.3V
PB58	CD50
PB59	CD49
PB60	+3.3V
PB61	CD48
PB62	E7
PB63	+3.3V
PB64	E6
PB65	CD47
PB66	+3.3V

BETA RELEASE

PB67 CD46
PB68 CD45
PB69 +3.3V
PB70 CD44
PB71 CD43
PB72 +3.3V
PB73 CD42
PB74 CD41
PB75 +3.3V
PB76 CD40
PB77 CD39
PB78 +3.3V
PB79 CD38
PB80 CD37
PB81 +3.3V
PB82 CD36
PB83 CD35
PB84 +3.3V
PB85 CD34
PB86 CD33
PB87 +3.3V
PB88 CD32
PB89 E5
PB90 +3.3V
PB91 E4

Contributor: Joakim Ögren <qtech@mailhost.net>

Sources: C-bus II Technology architecture <<http://www.corollary.com/cbusii.html>> at Collary's homepage
<<http://www.collary.com>>

Please send any comments to Joakim Ögren <qtech@mailhost.net>

SSFDC

SSFDC=Solid State Floppy Disk Card.

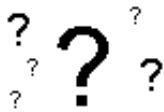

(At the motherboard)

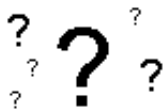

(At the device)

UNKNOWN CONNECTOR at the motherboard.

UNKNOWN CONNECTOR at the device.

I don't have any technical information about SSFDC at the moment. If you have any information of value please send it to me.

Contributor: Joakim Ögren <qtech@mailhost.net>

Source: ?

Info: Solid State Floppy Disk Card Forum <<http://www.ssfdc.com>>

Please send any comments to Joakim Ögren <qtech@mailhost.net>.

PC/104

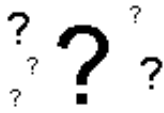

(At the backplane)

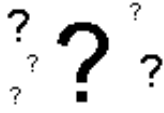

(At the device (card))

UNKNOWN CONNECTOR at the backplane.

UNKNOWN CONNECTOR at the device (card).

Pin Number	J1/P1 Row A	J1/P1 Row B	J2/P2 Row C1	J2/P2 Row D1
0	--	--	0V	0V
1	IOCHCHK*	0V	SBHE*	MEMCS16*
2	SD7	RESETDRV	LA23	IOCS16*
3	SD6	+5V	LA22	IRQ10
4	SD5	IRQ9	LA21	IRQ11
5	SD4	-5V	LA20	IRQ12
6	SD3	DRQ2	LA19	IRQ15
7	SD2	-12V	LA18	IRQ14
8	SD1	ENDXFR*	LA17	DACK0*
9	SD0	+12V	MEMR*	DRQ0
10	IOCHRDY	(KEY)2	MEMW*	DACK5*
11	AEN	SMEMW*	SD8	DRQ5
12	SA19	SMEMR*	SD9	DACK6*
13	SA18	IOW*	SD10	DRQ6
14	SA17	IOR*	SD11	DACK7*
15	SA16	DACK3*	SD12	DRQ7
16	SA15	DRQ3	SD13	+5V
17	SA14	DACK1*	SD14	MASTER*
18	SA13	DRQ1	SD15	0V
19	SA12	REFRESH*		(KEY)2 0V
20	SA11	SYSCLK	--	--
21	SA10	IRQ7	--	--
22	SA9	IRQ6	--	--
23	SA8	IRQ5	--	--
24	SA7	IRQ4	--	--
25	SA6	IRQ3	--	--
26	SA5	DACK2*	--	--
27	SA4	TC	--	--
28	SA3	BALE	--	--
29	SA2	+5V	--	--
30	SA1	OSC	--	--
31	SA0	0V	--	--
32	0V	0V	--	--

Contributor: Joakim Ögren <qtech@mailhost.net>

Sources: PC/104 Consortium <<http://www.pc104.org/pc104/consp5.html>>

Sources: PC/104 pinout

<<http://www.pc104.org/pc104/pinouts.html>>Info: PC/104 Consortium <<http://www.pc104.org/pc104/consp1.html>>

Please send any comments to Joakim Ögren <qtech@mailhost.net>.

BETA RELEASE

Unibus

Available on the old Digital PDP-11.

AA1	AB1	AC1	//	AU1	AV1	BA1	BB1	BC1	//	BU1	BV1
AA2	AB2	AC2	//	AU2	AV2	BA2	BB2	BC2	//	BU2	BV2

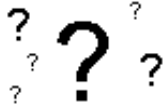

(At the computer)

2 x 36 EDGE FEMALE at the backplane.
2 x 36 EDGE MALE at the cards/modules.

PIN	SIGNAL
AA1	/INIT
AA2	POWER(+5v)
AB1	/INTR
AB2	GROUND
AC1	/D00
AC2	GROUND
AD1	/D02
AD2	/D01
AE1	/D04
AE2	/D03
AF1	/D06
AF2	/D05
AH1	/D08
AH2	/D07
AJ1	/D10
AJ2	/D09
AK1	/D12
AK2	/D11
AL1	/D14
AL2	/D13
AM1	/PA
AM2	/D15
AN1	GROUND
AN2	/PB
AP1	GROUND
AP2	/BBSY
AR1	GROUND
AR2	/SACK
AS1	GROUND
AS2	/NPR
AT1	GROUND
AT2	/BR7
AU1	NPG
AU2	/BR6
AV1	BG7
AV2	GROUND
BA1	BG6
BA2	POWER(+5v)
BB1	BG5
BB2	GROUND
BC1	/BR5
BC2	GROUND

BETA RELEASE

BD1 GROUND
BD2 /BR4
BE1 GROUND
BE2 BG4
BF1 /ACLO
BF2 /DCLO
BH1 /A01
BH2 /A00
BJ1 /A03
BJ2 /A02
BK1 /A05
BK2 /A04
BL1 /A07
BL2 /A06
BM1 /A09
BM2 /A08
BN1 /A11
BN2 /A10
BP1 /A13
BP2 /A12
BR1 /A15
BR2 /A14
BS1 /A17
BS2 /A16
BT1 GROUND
BT2 /C1
BU1 /SSYN
BU2 /CO
BV1 /MSYN
BV2 GROUND

Contributor: Rob Gill <gillz@mpx.com.au>

Source: Digital PDP-11 peripherals handbook

Please send any comments to Joakim Ögren <qtech@mailhost.net>.

RS232

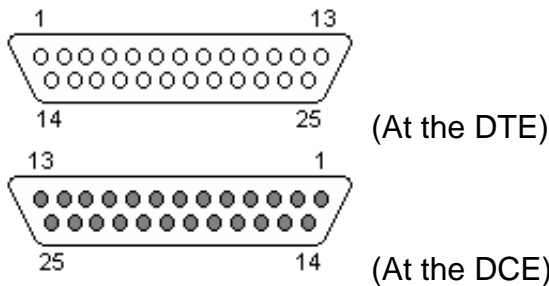

25 PIN D-SUB MALE at the DTE (Computer).
25 PIN D-SUB FEMALE at the DCE (Modem).

Pin	Name	ITU-T	Dir	Description
1	GND	101	—	Shield Ground
2	TXD	103	→	Transmit Data
3	RXD	104	←	Receive Data
4	RTS	105	→	Request to Send
5	CTS	106	←	Clear to Send
6	DSR	107	←	Data Set Ready
7	GND	102	—	System Ground
8	CD	109	←	Carrier Detect
9	-	-	-	RESERVED
10	-	-	-	RESERVED
11	STF	126	→	Select Transmit Channel
12	S.CD	?	←	Secondary Carrier Detect
13	S.CTS	?	←	Secondary Clear to Send
14	S.TXD	?	→	Secondary Transmit Data
15	TCK	114	←	Transmission Signal Element Timing
16	S.RXD	?	←	Secondary Receive Data
17	RCK	115	←	Receiver Signal Element Timing
18	LL	141	→	Local Loop Control
19	S.RTS	?	→	Secondary Request to Send
20	DTR	108	→	Data Terminal Ready
21	RL	140	→	Remote Loop Control
22	RI	125	←	Ring Indicator
23	DSR	111	→	Data Signal Rate Selector
24	XCK	113	→	Transmit Signal Element Timing
25	TI	142	←	Test Indicator

Note: Direction is DTE (Computer) relative DCE (Modem).

Note: Do not connect SHIELD(1) to GND(7).

Contributor: Joakim Ögren <qtech@mailhost.net>, Petr Krc <magneton@mail.firstnet.cz>

Source: ?

Please send any comments to Joakim Ögren <qtech@mailhost.net>.

Serial (PC 9)

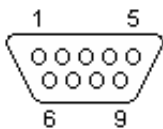

(At the Computer)

9 PIN D-SUB MALE at the Computer.

Pin	Name	Dir	Description
1	CD	←	Carrier Detect
2	RXD	←	Receive Data
3	TXD	→	Transmit Data
4	DTR	→	Data Terminal Ready
5	GND	—	System Ground
6	DSR	←	Data Set Ready
7	RTS	→	Request to Send
8	CTS	←	Clear to Send
9	RI	←	Ring Indicator

Note: Direction is DTE (Computer) relative DCE (Modem).

Contributor: Joakim Ögren <qtech@mailhost.net>

Source: ?

Please send any comments to Joakim Ögren <qtech@mailhost.net>.

PRELIMINARY BETA. NOT FOR REDISTRIBUTION.

Serial (PC 25)

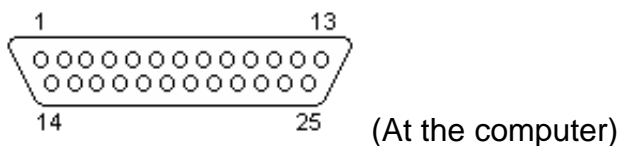

25 PIN D-SUB MALE at the computer.

Pin	Name	Dir	Description
1	SHIELD	-	Shield Ground
2	TXD	→	Transmit Data
3	RXD	←	Receive Data
4	RTS	→	Request to Send
5	CTS	←	Clear to Send
6	DSR	←	Data Set Ready
7	GND	-	System Ground
8	CD	←	Carrier Detect
9	n/c	-	
10	n/c	-	
11	n/c	-	
12	n/c	-	
13	n/c	-	
14	n/c	-	
15	n/c	-	
16	n/c	-	
17	n/c	-	
18	n/c	-	
19	n/c	-	
20	DTR	→	Data Terminal Ready
21	n/c	-	
22	RI	←	Ring Indicator
23	n/c	-	
24	n/c	-	
25	n/c	-	

Note: Direction is DTE (Computer) relative DCE (Modem).

Note: Do not connect SHIELD(1) to GND(7).

Contributor: Joakim Ögren <qtech@mailhost.net>

Source: Amiga 4000 User's Guide from Commodore

Please send any comments to Joakim Ögren <qtech@mailhost.net>.

Serial (Amiga 1000)

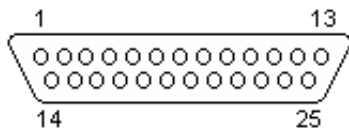

(At the Amiga 1000)

25 PIN D-SUB MALE at the Amiga 1000.

Pin Name	Dir	Description
1 SHIELD	—	Shield Ground
2 TXD	→	Transmit Data
3 RXD	←	Receive Data
4 RTS	→	Request to Send
5 CTS	←	Clear to Send
6 DSR	←	Data Set Ready
7 GND	—	System Ground
8 CD	←	Carrier Detect
9 n/c	-	
10 n/c	-	
11 n/c	-	
12 n/c	-	
13 n/c	-	
14 -5V	→	-5 Volts DC (50mA max)
15 AUDO	→	Amiga Audio Out (Left)
16 AUDI	←	Amiga Audio In (Right)
17 EB	-	EB=Buffered Port Clock 716 kHz
18 /INT2	?	Interrupt 2
19 n/c	-	
20 DTR	→	Data Terminal Ready
21 +5V	→	+5 Volts DC
22 n/c	-	
23 +12V	→	+12 Volts DC (20 mA max)
24 /C2	→	C2=Clock 3.58MHz
25 /RESET	→	Reset

Note: Direction is DTE (Computer) relative DCE (Modem).

Note: Do not connect SHIELD(1) to GND(7).

Contributor: Joakim Ögren <qtech@mailhost.net>

Source: Amiga 4000 User's Guide from Commodore

Please send any comments to Joakim Ögren <qtech@mailhost.net>.

Serial (Amiga)

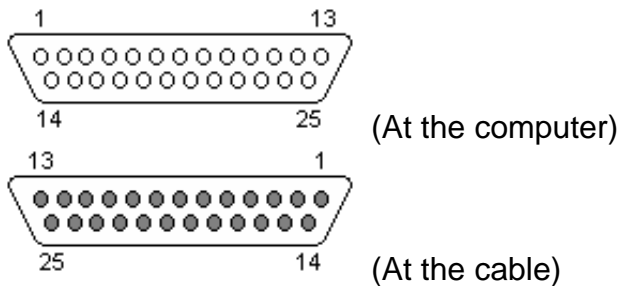

25 PIN D-SUB MALE at the computer.

25 PIN D-SUB FEMALE at the cable.

Pin Name	Dir	Description
1	SHIELD	Shield Ground
2	TXD	Transmit Data
3	RXD	Receive Data
4	RTS	Request to Send
5	CTS	Clear to Send
6	DSR	Data Set Ready
7	GND	System Ground
8	CD	Carrier Detect
9	+12V	+12 Volts DC (20 mA max)
10	-12V	-12 Volts DC (20 mA max)
11	AUDO	Amiga Audio Out (Left)
12	n/c	Speed Indicate
13	n/c	-
14	n/c	-
15	n/c	-
16	n/c	-
17	n/c	-
18	AUDI	Amiga Audio In (Right)
19	n/c	-
20	DTR	Data Terminal Ready
21	n/c	-
22	RI	Ring Indicator
23	n/c	-
24	n/c	-
25	n/c	-

Note: Direction is DTE (Computer) relative DCE (Modem).

Note: Do not connect SHIELD(1) to GND(7).

Contributor: Joakim Ögren <qtech@mailhost.net>

Source: Amiga 4000 User's Guide from Commodore

Please send any comments to Joakim Ögren <qtech@mailhost.net>.

Serial (MSX)

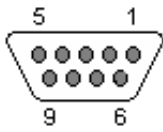

(At the Computer)

9 PIN D-SUB FEMALE at the Computer.

Pin	Name	Dir	Description
1	PG	-	Protective Ground
2	TXD	→	Transmit Data
3	RXD	←	Receive Data
4	RTS	→	Request to Send
5	CTS	←	Clear to Send
6	DSR	←	Data Set Ready
7	GND	-	Signal Ground
8	DCD	←	Carrier Detect
9	DTR	→	Data Terminal Ready

Note: Direction is DTE (Computer) relative DCE (Modem).

Contributor: Joakim Ögren <qtech@mailhost.net>

Source: Mayer's SV738 X'press I/O map <<http://www.freeflight.com/fms/MSX/Portar.txt>>

Please send any comments to Joakim Ögren <qtech@mailhost.net>.

Serial (Printer)

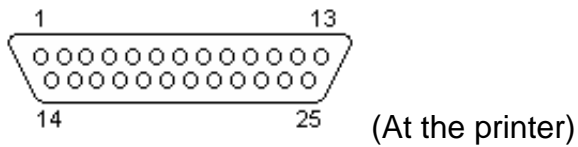

25 PIN D-SUB MALE at the printer.

Pin	Pin Name	Dir	Description
1	SHIELD	—	Shield Ground
2	TXD	→	Transmit Data
3	RXD	←	Receive Data
4	n/c	-	Not connected
5	n/c	-	Not connected
6	DSR	←	Data Set Ready
7	GND	—	System Ground
8	DCD	←	Data Carrier Detect
9	n/c	-	Not connected
10	n/c	-	Not connected
11	?	→	Reverse Channel
12	n/c	-	Not connected
13	n/c	-	Not connected
14	n/c	-	Not connected
15	n/c	-	Not connected
16	n/c	-	Not connected
17	TTY-TXD	→	TTY Receive Data
18	n/c	-	Not connected
19	n/c	-	Not connected
20	DTR	→	Data Terminal Ready
21	n/c	-	Not connected
22	n/c	-	Not connected
23	?	→	TTY Receive Data Return
24	?	←	TTY Transmit Data Return
25	TTY-RXD	←	TTY Receive Data

Contributor: Joakim Ögren <qtech@mailhost.net>, Petr Krc <magneton@mail.firstnet.cz>

Source: ?

Please send any comments to Joakim Ögren <qtech@mailhost.net>.

DEC Dual RS-232

Found on the DEC Multia and DEC UDB. It contains two Serial ports on one connector. The 1st Port is located on the normal pins, and the 2nd port is located on some "spare" pins.

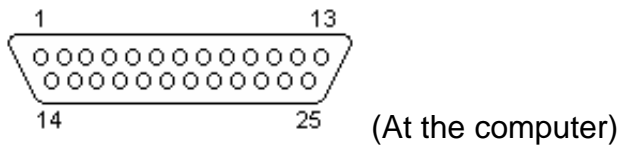

25 PIN D-SUB MALE at the computer.

Pin	Port	Name	Dir	Description
1		n/c		Not connected
2	1	TXD	→	Transmit Data
3	1	RXD	←	Receive Data
4	1	RTS	→	Ready To Send
5	1	CTS	←	Clear To Send
6	1	DSR	←	Data Set Ready
7	1+2	GND	-	Ground
8	1	DCD	←	Data Carrier Detect
9		n/c		Not connected
10		n/c		Not connected
11	2	DTR	→	Data Terminal Ready
12	2	DCD	←	Data Carrier Detect
13	2	CTS	←	Clear To Send
14	2	TXD	→	Transmit Data
15		n/c		Not connected
16	2	RXD	←	Receive Data
17		n/c		Not connected
18		n/c		Not connected
19	2	RTS	→	Ready To Send
20	1	DTR	→	Data Terminal Ready
21		n/c		Not connected
22	1	RI	←	Ring Indicator
23	2	DSR	←	Data Set Ready
24		n/c		Not connected
25	2	RI	←	Ring Indicator

Note: Direction is DTE (Computer) relative DCE (Modem).

Contributor: Joakim Ögren <qtech@mailhost.net>

Source: Tommy's pinout Collection <<http://csgrad.cs.vt.edu/~tjohnson/pinouts>> by Tommy Johnson <tjohnson@csgrad.cs.vt.edu>

Please send any comments to Joakim Ögren <qtech@mailhost.net>.

Macintosh RS-422

It's possible to connect RS-232 peripheral to the RS-422 port available on Macintosh computers. Use RXD- as RXD, TXD- as TXD, Ground RXD+, Leave TXD+ unconnected, GPi as CD.

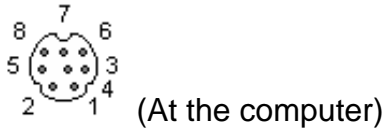

8 PIN MINI-DIN FEMALE at the computer.

Pin Name	Dir	Description
1 HSKo	→	Output Handshake
2 HSKi/CLK	←	Input Handshake or External Clock
3 TXD-	→	Transmit Data (-)
4 GND		Ground
5 RXD-	←	Receive Data (-)
6 TXD+	→	Transmit Data (+)
7 GPi	←	General Purpose Input
8 RXD+	←	Receive Data (+)

Note: Direction is DTE (Computer) relative DCE (Modem).

Note: GPi is connected to SCC Data Carrier Detect (or to Receive/Transmit Clock if the VIA1 SYNC signal is high). Not connected on the Macintosh Plus, Classic, Classic II, LC, LC II or IIsi.

Contributor: Joakim Ögren <qtech@mailhost.net>, Pierre Olivier <olipie@aei.ca>, Ben Harris <bjh@mail.dotcom.fr>

Sources: comp.sys.mac.comm FAQ Part 1

<<http://www.cis.ohio-state.edu/hypertext/faq/usenet/macintosh/comm-faq/part1/faq.html>>

Sources: Apple Tech Info Library, Article ID: TECHINFO-0001699

Please send any comments to Joakim Ögren <qtech@mailhost.net>.

RS422

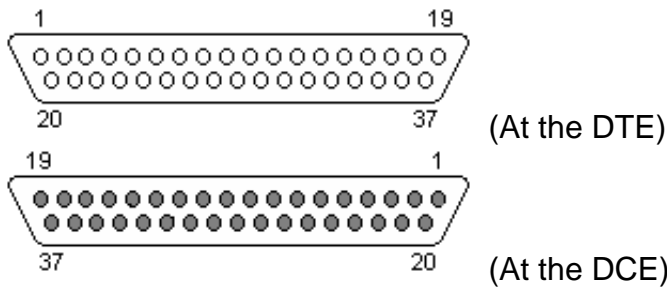

37 PIN D-SUB MALE at the DTE (Computer).
37 PIN D-SUB FEMALE at the DCE (Modem).

Pin Name	Dir	Description
1	GND	Shield Ground
2	SRI	Signal Rate Indicator
3	n/c	Spare
4	SD	Send Data
5	ST	Send Timing
6	RD	Receive Data
7	RTS	Request To Send
8	RR	Receiver Ready
9	CTS	Clear To Send
10	LL	Local Loopback
11	DM	Data Modem
12	TR	Terminal Ready
13	RR	Receiver Ready
14	RL	Remote Loopback
15	IC	Incoming Call
16	SF/SR	Select Frequency/Select Rate
17	TT	Terminal Timing
18	TM	Test Mode
19	GND	Ground
20	RC	Receive Twister-Pair Common
21	GND	Spare Twister-Pair Return
22	/SD	Send Data TPR
23	GND	Send Timing TPR
24	GND	Receive Timing TPR
25	/RS	Request To Send TPR
26	/RT	Receive Timing TPR
27	/CS	Clear To Send TPR
28	IS	Terminal In Service
29	/DM	Data Mode TPR
30	/TR	Terminal Ready TPR
31	/RR	Receiver TPR
32	SS	Select Standby
33	SQ	Signal Quality
34	NS	New Signal
35	/TT	Terminal Timing TPR
36	SB	Standby Indicator
37	SC	Send Twister Pair Common

Note: Direction is DTE (Computer) relative DCE (Modem).

Contributor: Joakim Ögren <qtech@mailhost.net>, Petr Krc <magneton@mail.firstnet.cz>

Source: ?

Please send any comments to Joakim Ögren <qtech@mailhost.net>.

BETA RELEASE

Macintosh Serial

Available on Macintosh Mac 512KE and earlier.

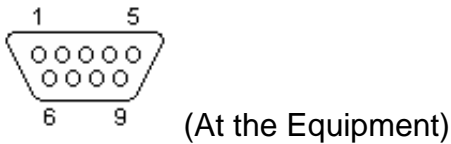
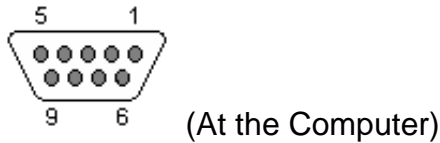

9 PIN D-SUB FEMALE at the computer.

9 PIN D-SUB MALE at the mouse cable.

Pin	Pin Name	Dir	Description
1	GND	—	Ground
2	+5V	→	+5 VDC. Don't use this one, it may be converted into output handshake in later equipment.
3	GND	—	Ground
4	Tx+	→	Transmit Data, positive going component
5	Tx-	→	Transmit Data, negative going component
6	+12V	→	+12 VDC
7	DSR/HSK	←	Handshake input. Signal name depends on mode: Used for Flow Control or Clock In.
8	Rx+	←	Receive Data, positive going component
9	Rx-	←	Receive Data, negative going component

Note: Direction is Computer relative Equipment.

Contributor: Ben Harris <bjh@mail.dotcom.fr>

Source: Apple Tech Info Library, Article ID: TECHINFO-0001424

Please send any comments to Joakim Ögren <qtech@mailhost.net>.

C64 RS232 User Port

Available on the Commodore C64/C128. Software emulated. The signals does not have true RS232 levels. It's TTL level, and RXD/TXD is inverted. It's just the normal User Port, used as a RS232 port.

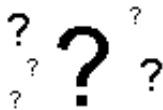

(At the computer)

UNKNOWN CONNECTOR at the computer.

Pin	Name	RS232	Description
A	GND	GND	Protective Ground
B+C	FLAG2+PB0	RxD	Receive Data (Must be applied to both pins!)
D	PB1	RTS	Ready To Send
E	PB2	DTR	Data Terminal Ready
F	PB3	RI	Ring Indicator
H	PB4	DCD	Data Carrier Detect
K	PB6	CTS	Clear To Send
L	PB7	DSR	Data Set Ready
M	PA2	TxD	Transmit Data
N	GND	GND	Signal Ground

Contributor: Joakim Ögren <qtech@mailhost.net>, Arwin Vosselman <0vosselman01@flnet.nl>, Mark Sokos <msokos1@gl.umbc.edu>

Source: Usenet posting in comp.sys.cbm, Help on modem -> c64

<http://www.vuse.vanderbilt.edu/~thompsbb/cbm_conn.txt> by Lasher Glenn <gl8574@lima.albany.edu>

Sources: Commodore 64 Programmer's Reference Guide

Please send any comments to Joakim Ögren <qtech@mailhost.net>.

DEC DLV11-J Serial

Available on the DEC DLV11-J Serial card

**NOT
DRAWN
YET...**



(at the serial card)

10 PIN IDC MALE at the Serial card.

Pin	Name	Dir	Description
1	CLK	?	Clock
2	GND	—	Ground
3	TXD+	→	Transmit data +
4	TXD-	→	Transmit data - (0V for RS-232, Reader enable for 20mA)
5	GND	—	Ground
6	n/c	-	Not connected (no pin)
7	RXD-	←	Receive data -
8	RXD+	←	Receive data +
9	GND	—	Ground
10	+12V	→	+12 VDC

Note: Direction is Serial card relative other Devices.

Contributor: Ben Harris <bjh@mail.dotcom.fr>

Source: DEC DLV11-J Printset, M8043-0-1, sheet 7

Please send any comments to Joakim Ögren <qtech@mailhost.net>

Cisco Console Port

Used to configure a Cisco router.

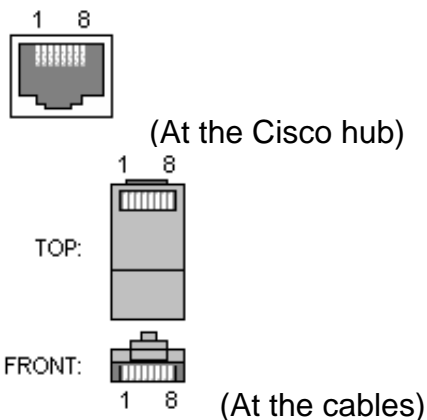

RJ45 FEMALE CONNECTOR at the Cisco routers.
RJ45 MALE CONNECTOR at the cables.

Pin	Name	Description	Dir
1	RTS	Request To Send	→
2	DTR	Data Terminal Ready	→
3	TXD	Transceive Data	→
4	n/c	Not connected	
5	n/c	Not connected	
6	RXD	Receive Data	←
7	DSR	Data Set Ready	←
8	CTS	Clear To Send	←

Contributor: Joakim Ögren <qtech@mailhost.net>, Damien Miller <dmliller@vitnet.com.sg>

Source: ?

Please send any comments to Joakim Ögren <qtech@mailhost.net>.

RocketPort Serialport

Available at RocketPort serialport expansion cards.

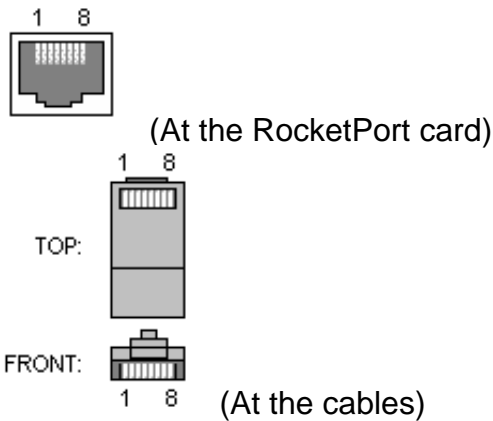

RJ45 FEMALE CONNECTOR at the RocketPort card.

RJ45 MALE CONNECTOR at the cables.

Pin	Name	Description	Dir
1	RTS	Request To Send	→
2	DTR	Data Terminal Ready	→
3	GND	Ground	→
3	TXD	Transceive Data	→
6	RXD	Receive Data	←
6	DCD	Data Carrier Detect	←
7	DSR	Data Set Ready	←
8	CTS	Clear To Send	←

Contributor: Joakim Ögren <qtech@mailhost.net>, Karl Asha <karl@blackdown.com>

Source: ?

Please send any comments to Joakim Ögren <qtech@mailhost.net>.

CoCo Serial Printer

Available on the Tandy Color Computer, also known as CoCo.

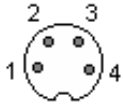

(At the computer)

4 PIN DIN 270° FEMALE at the computer.

Pin Name	Description
----------	-------------

1	NC
2	/BUSY Enabled when the printer is busy
3	GND
4	DATA RS-232 level data

Contributer: Rob Gill <gillz@mpx.com.au>

Source: Tandy TRP 100 printer manual

Please send any comments to Joakim Ögren <qtech@mailhost.net>.

PRELIMINARY BETA. NOT FOR REDISTRIBUTION.

Conrad Electronics MM3610D

This connector is available on the Conrad Electronics Multimeter 3610D and is used to connect it to a computer.

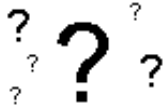

(At the multimeter).

5 PIN UNKNOWN CONNECTOR at the multimeter

Conrad Name	Description	Dir
1	RTS Request To Send	←↑
2	RXD Receive Data	→↑
3	TXD Transmit Data	←↑
4	DTR Data Terminal Ready	←↑
5	GND Ground	—

Note: Since the multimeter is a DCE the pin naming can seem strange.

Contributors: Joakim Ögren <qtech@mailhost.net>, Anselm Belz <a.belz@samson.mbis.de>

Source: ?

Please send any comments to Joakim Ögren <qtech@mailhost.net>.

Parallel (PC)

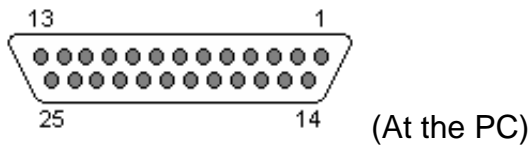

25 PIN D-SUB FEMALE at the PC.

Pin Name	Dir	Description
1	/STROBE	→ Strobe
2	D0	→ Data Bit 0
3	D1	→ Data Bit 1
4	D2	→ Data Bit 2
5	D3	→ Data Bit 3
6	D4	→ Data Bit 4
7	D5	→ Data Bit 5
8	D6	→ Data Bit 6
9	D7	→ Data Bit 7
10	/ACK	← Acknowledge
11	BUSY	← Busy
12	PE	← Paper End
13	SEL	← Select
14	/AUTOFD	→ Autofeed
15	/ERROR	← Error
16	/INIT	→ Initialize
17	/SELIN	→ Select In
18	GND	— Signal Ground
19	GND	— Signal Ground
20	GND	— Signal Ground
21	GND	— Signal Ground
22	GND	— Signal Ground
23	GND	— Signal Ground
24	GND	— Signal Ground
25	GND	— Signal Ground

Note: Direction is Computer relative Device.

Contributor: Joakim Ögren <qtech@mailhost.net>, Petr Krc <magneton@mail.firstnet.cz>

Source: ?

Please send any comments to Joakim Ögren <qtech@mailhost.net>.

Parallel (Amiga)

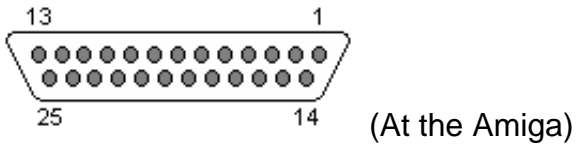

25 PIN D-SUB FEMALE at the Amiga.

Pin Name	Dir	Description
1 /STROBE	→	Strobe
2 D0	↔	Data Bit 0
3 D1	↔	Data Bit 1
4 D2	↔	Data Bit 2
5 D3	↔	Data Bit 3
6 D4	↔	Data Bit 4
7 D5	↔	Data Bit 5
8 D6	↔	Data Bit 6
9 D7	↔	Data Bit 7
10 /ACK	←	Acknowledge
11 BUSY	↔	Busy
12 POUT	↔	Paper Out
13 SEL	↔	Select (Shared with RS232 RING-indicator)
14 +5V PULLUP	→	+5 Volts DC (10 mA max)
15 n/c	-	Not connected.
16 /RESET	→	Reset
17 GND	—	Signal Ground
18 GND	—	Signal Ground
19 GND	—	Signal Ground
20 GND	—	Signal Ground
21 GND	—	Signal Ground
22 GND	—	Signal Ground
23 GND	—	Signal Ground
24 GND	—	Signal Ground
25 GND	—	Signal Ground

Note: Direction is Computer relative Peripheral.

Contributor: Joakim Ögren <qtech@mailhost.net>

Source: Amiga 4000 User's Guide from Commodore

Please send any comments to Joakim Ögren <qtech@mailhost.net>.

Parallel (Amiga 1000)

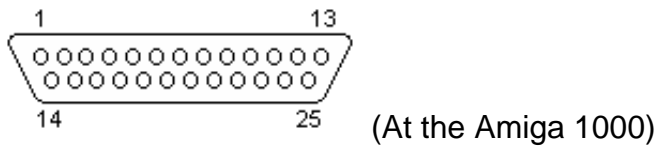

25 PIN D-SUB MALE at the Amiga 1000.

Pin Name	Dir	Description
1 /STROBE	→	Strobe
2 D0	↔	Data Bit 0
3 D1	↔	Data Bit 1
4 D2	↔	Data Bit 2
5 D3	↔	Data Bit 3
6 D4	↔	Data Bit 4
7 D5	↔	Data Bit 5
8 D6	↔	Data Bit 6
9 D7	↔	Data Bit 7
10 /ACK	←	Acknowledge
11 BUSY	↔	Busy
12 POUT	↔	Paper Out
13 SEL	↔	Select (Shared with RS232 RING-indicator)
14 GND	—	Signal Ground
15 GND	—	Signal Ground
16 GND	—	Signal Ground
17 GND	—	Signal Ground
18 GND	—	Signal Ground
19 GND	—	Signal Ground
20 GND	—	Signal Ground
21 GND	—	Signal Ground
22 GND	—	Signal Ground
23 +5V	→	+5 Volts DC (10 mA max)
24 n/c	-	Not connected.
25 /RESET	→	Reset

Note: Direction is Computer relative Peripheral.

Contributor: Joakim Ögren <qtech@mailhost.net>

Source: Amiga 4000 User's Guide from Commodore

Please send any comments to Joakim Ögren <qtech@mailhost.net>.

ECP Parallel

ECP = Extended Capabilities Port

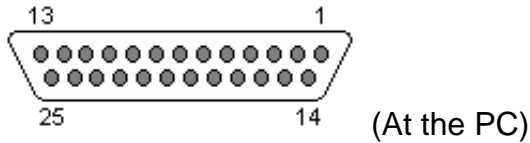

25 PIN D-SUB FEMALE at the PC.

Pin Name	Dir	Description
1	nStrobe	→ Strobe
2	data0	↔ Address, Data or RLE Data Bit 0
3	data1	↔ Address, Data or RLE Data Bit 1
4	data2	↔ Address, Data or RLE Data Bit 2
5	data3	↔ Address, Data or RLE Data Bit 3
6	data4	↔ Address, Data or RLE Data Bit 4
7	data5	↔ Address, Data or RLE Data Bit 5
8	data6	↔ Address, Data or RLE Data Bit 6
9	data7	↔ Address, Data or RLE Data Bit 7
10	/nAck	↑ Acknowledge
11	Busy	↑ Busy
12	PError	↑ Paper End
13	Select	↑ Select
14	/nAutoFd	→ Autofeed
15	/nFault	↑ Error
16	/nInit	→ Initialize
17	/nSelectIn	→ Select In
18	GND	— Signal Ground
19	GND	— Signal Ground
20	GND	— Signal Ground
21	GND	— Signal Ground
22	GND	— Signal Ground
23	GND	— Signal Ground
24	GND	— Signal Ground
25	GND	— Signal Ground

Note: Direction is Computer relative Device.

Contributor: Joakim Ögren <qtech@mailhost.net>, Marco Furter <maf@pop.agri.ch>

Source: Microsoft MSDN Library: Extended Capabilities Port Specs

Info: Microsoft MSDN Library <<http://www.microsoft.com/msdn>>

Please send any comments to Joakim Ögren <qtech@mailhost.net>.

ECP Parallel (Technical)

This file is designed to give a basic overview of the port found in most newer PC computers called ECP Parallel port.

This file is not intended to be a thorough coverage of the standard. It is for informational purposes only, and is intended to give designers and hobbyists sufficient information to design their own ECP compatible devices.

Signal Descriptions:

nStrobe

This signal registers data or address into the slave on the asserting edge during .

data 0-7

Contains address, data or RLE data. Can be used in both directions.

nAck

Valid data driven by the peripheral when asserted. This signal handshakes with nAutoFd in reverse.

Busy

This signal deasserts to indicate that the peripheral can accept data. In forward direction this handshakes with nStrobe. In the reverse direction this signal indicates that the data is RLE compressed by being low.

PError

Used to acknowledge a change in the direction of transfer. High=Forward.

Select

Printer is online.

nAutoFd

Requests a byte of data from the peripheral when asserted, handshaking with nAck in the reverse direction. In the forward direction this signal indicates whether the data lines contain ECP address or data.

nFault

Generates an error interrupt when asserted.

nInit

Sets the transfer direction. High=Reverse, Low=Forward.

nSelectIn

Low in ECP mode.

Contributor: Joakim Ögren <qtech@mailhost.net>

Source: Microsoft MSDN Library: Extended Capabilities Port Specs

Info: Microsoft MSDN Library <<http://www.microsoft.com/msdn>>

Please send any comments to Joakim Ögren <qtech@mailhost.net>.

Centronics

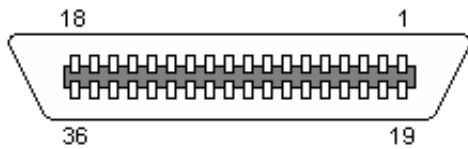

(At the Printer)

36 PIN CENTRONICS FEMALE at the Printer.

Pin Name	Dir	Description
1 /STROBE	←	Strobe
2 D0	↔	Data Bit 0
3 D1	↔	Data Bit 1
4 D2	↔	Data Bit 2
5 D3	↔	Data Bit 3
6 D4	↔	Data Bit 4
7 D5	↔	Data Bit 5
8 D6	↔	Data Bit 6
9 D7	↔	Data Bit 7
10 /ACK	→	Acknowledge
11 BUSY	→	Busy
12 POUT	→	Paper Out
13 SEL	→	Select
14 /AUTOFEED	←	Autofeed
15 n/c	-	Not used
16 0 V	—	Logic Ground
17 CHASSIS GND	—	Shield Ground
18 +5 V PULLUP	→	+5 V DC (50 mA max)
19 GND	—	Signal Ground (Strobe Ground)
20 GND	—	Signal Ground (Data 0 Ground)
21 GND	—	Signal Ground (Data 1 Ground)
22 GND	—	Signal Ground (Data 2 Ground)
23 GND	—	Signal Ground (Data 3 Ground)
24 GND	—	Signal Ground (Data 4 Ground)
25 GND	—	Signal Ground (Data 5 Ground)
26 GND	—	Signal Ground (Data 6 Ground)
27 GND	—	Signal Ground (Data 7 Ground)
28 GND	—	Signal Ground (Acknowledge Ground)
29 GND	—	Signal Ground (Busy Ground)
30 /GNDRESET	—	Reset Ground
31 /RESET	←	Reset
32 /FAULT	→	Fault (Low when offline)
33 0 V	—	Signal Ground
34 n/c	-	Not used
35 +5 V	→	+5 V DC
36 /SLCT IN	←	Select In (Taking low or high sets printer on line or off line respectively)

Note: Direction is Printer relative Computer.

Contributor: Joakim Ögren <qtech@mailhost.net>, Peter Korsgaard <jacmet@post5.tele.dk>, Petr Krc <magneton@mail.firstnet.cz>

Source: ?

Please send any comments to Joakim Ögren <qtech@mailhost.net>.

MSX Parallel

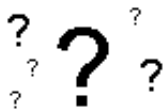

(At the Computer)

14 PIN CENTRONICS FEMALE at the Computer.

Pin Name	Dir	Description
1	/STB	Strobe
2	PDB0	Data 0
3	PDB1	Data 1
4	PDB2	Data 2
5	PDB3	Data 3
6	PDB4	Data 4
7	PDB5	Data 5
8	PDB6	Data 6
9	PDB7	Data 7
10	n/c	-
11	BUSY	Printer is busy
12	n/c	-
13	n/c	-
14	GND	Signal Ground

*Note: Direction is Computer relative Printer.**Contributor: Joakim Ögren <qtech@mailhost.net>**Source: Mayer's SV738 X'press I/O map <<http://www.freeflight.com/fms/MSX/Portar.txt>>**Please send any comments to Joakim Ögren <qtech@mailhost.net>*

Parallel (Olivetti M10)

Available on an old portable computer called Olivetti M10.

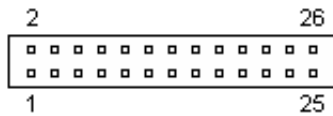

(At the Computer)

26 PIN IDC MALE at the Computer.

Pin Name	Dir	Description
1 /STROBE	→	Strobe
2 D0	→	Data Bit 0
3 D1	→	Data Bit 1
4 D2	→	Data Bit 2
5 D3	→	Data Bit 3
6 D4	→	Data Bit 4
7 D5	→	Data Bit 5
8 D6	→	Data Bit 6
9 D7	→	Data Bit 7
10 /ACK	←	Acknowledge
11 BUSY	←	Busy
12 PE	←	Paper End
13 SELIN	←	Select In
14 GND		Signal Ground
15 GND		Signal Ground
16 GND		Signal Ground
17 GND		Signal Ground
18 GND		Signal Ground
19 GND		Signal Ground
20 GND		Signal Ground
21 GND		Signal Ground
22 GND		Signal Ground
23 GND		Signal Ground
24 GND		Signal Ground
25 RESETGND		Reset Ground
26 /RESET	←	Reset

Note: Direction is Computer relative Device.

Contributor: Joakim Ögren <qtech@mailhost.net>, Filippo Fiani <nathannever@rocketmail.com>

Source: ?

Please send any comments to Joakim Ögren <qtech@mailhost.net>.

Amstrad CPC6128 Printer Port

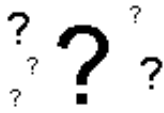

(At the computer)

34 PIN FEMALE EDGE at the computer.

Pin Name	Description
1	/STROBE Strobe
2	D0 Data 0
3	D1 Data 1
4	D2 Data 2
5	D3 Data 3
6	D4 Data 4
7	D5 Data 5
8	D6 Data 6
9	GND Ground
10	n/c Not connected
11	BUSY Busy
12	n/c Not connected
13	n/c Not connected
14	GND Ground
15	n/c Not connected
16	n/c Not connected
17	n/c Not connected
16	GND Ground
17	n/c Not connected
19	GND Ground
20	GND Ground
21	GND Ground
22	GND Ground
23	GND Ground
24	GND Ground
25	GND Ground
26	GND Ground
27	n/c Not connected
28	GND Ground
29	n/c Not connected
30	n/c Not connected
31	n/c Not connected
32	n/c Not connected
33	GND Ground
34	n/c Not connected
35	n/c Not connected

Note: Pin 18 doesn't exist

Contributor: Joakim Ögren <qtech@mailhost.net>, Agnello Guarracino <aggy@ooh.diron.co.uk>

Source: Amstrad CPC6128 User Instructions Manual

Please send any comments to Joakim Ögren <qtech@mailhost.net>.

Universal Serial Bus (USB)

Developed by Compaq, Digital Equipment Corp, IBM PC Co., Intel, Microsoft, NEC and Northern Telecom.

NOT

DRAWN

YET...



(At the controller)

NOT

DRAWN

YET...



(At the peripherals)

4 PIN ??? MALE at the controller.

4 PIN ??? FEMALE at the peripherals.

Pin Name Description

1	VCC	+5 VDC
2	D-	Data -
3	D+	Data +
4	GND	Ground

Contributor: Joakim Ögren <qtech@mailhost.net>

Sources: USB FAQ <<http://www.teleport.com/~usb/usbfaq.htm>> at USB Implementers Forum <<http://www.usb.org>>

Sources: USB Specification v1.0 at USB Implementers Forum <<http://www.usb.org>>

Please send any comments to Joakim Ögren <qtech@mailhost.net>.

Universal Serial Bus (USB) (Technical)

USB was developed by Compaq, Digital Equipment Corp, IBM PC Co., Intel, Microsoft, NEC and Northern Telecom.

Features:

- True Plug'n'Play.
- Hot plug and unplug
- Low cost
- Easy of use
- 127 physical devices
- Low cost cables and connectors

Bandwidth:

- Full speed: 12 Mbps speed (requires shielded cable)
- Low speed: 1.5 Mbps speed (non-shielded cable)

Definitions:

USB Host = The computer, only one host per USB system.

USB Device = A *hub* or a *Function*.

Power usage:

Bus-powered hubs: Draw Max 100 mA at power up and 500 mA normally.

Self-powered hubs: Draw Max 100 mA, must supply 500 mA to each port.

Low power, bus-powered functions: Draw Max 100 mA.

High power, bus-powered functions: Self-powered hubs: Draw Max 100 mA, must supply 500 mA to each port.

Self-powered functions: Draw Max 100 mA.

Suspended device: Max 0.5 mA

Voltage:

- Supplied voltage by a host or a powered hub ports is between 4.75 V and 5.25 V.
- Maximum voltage drop for bus-powered hubs is 0.35 V from it's host or hub to the hubs output port.
- All hubs and functions must be able to send configuration data at 4.4 V, but only low-power functions need to be working at this voltage.
- Normal operational voltage for functions is minimum 4.75 V.

Shielding:

Shield should only be connected to Ground at the host. No device should connect Shield to Ground.

Cable:

Shielded:

Data: 28 AWG twisted

Power: 28 AWG - 20 AWG non-twisted

Non-shielded:

Data: 28 AWG non-twisted

Power: 28 AWG - 20 AWG non-twisted

Power Gauge Max length

BETA RELEASE

28	0.81 m
26	1.31 m
24	2.08 m
22	3.33 m
20	5.00 m

Cable colors:

Pin Name	Cable color	Description
----------	-------------	-------------

1	VCC Red	+5 VDC
2	D- White	Data -
3	D+ Green	Data +
4	GND Black	Ground

Contributor: Joakim Ögren <qtech@mailhost.net>

Sources: USB FAQ <<http://www.teleport.com/~usb/usbfaq.htm>> at USB Implementers Forum <<http://www.usb.org>>

Sources: USB Specification v1.0 at USB Implementers Forum <<http://www.usb.org>>

Please send any comments to Joakim Ögren <qtech@mailhost.net>.

PRELIMINARY BETA. NOT FOR REDISTRIBUTION.

GeekPort

The GeekPort is a connector available at Be's BeBox computers. This is a dream for all hobby engineers who like to connect the computer to the coffee machine.

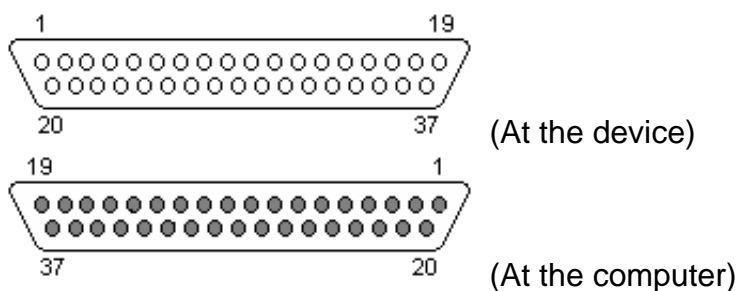

37 PIN D-SUB MALE CONNECTOR at the device.

37 PIN D-SUB FEMALE CONNECTOR at the computer.

Pin	Name	Description	Dir
1	GND	Ground	
2	A1	Digital A 1	↕
3	A3	Digital A 3	↕
4	A5	Digital A 5	↕
5	A7	Digital A 7	↕
6	GND	Ground	
7	+5V	+5 VDC	
8	GND	Ground	
9	+12V	+12 VDC	
10	GND	Ground	
11	-12V	-12 VDC	
12	GND	Ground	
13	+5V	+5 VDC	
14	GND	Ground	
15	B0	Digital B 0	↕
16	B2	Digital B 2	↕
17	B4	Digital B 4	↕
18	B6	Digital B 6	↕
19	GND	Ground	
20	A0	Digital A 0	↕
21	A2	Digital A 2	↕
22	A4	Digital A 4	↕
23	A6	Digital A 6	↕
24	Alref	Analog In Reference	↑
25	A2D1	Analog In 1	↑
26	A2D2	Analog In 2	↑
27	A2D3	Analog In 3	↑
28	A2D4	Analog In 4	↑
29	D2A1	Analog Out 1	↓
30	D2A2	Analog Out 2	↓
31	D2A3	Analog Out 3	↓
32	D2A4	Analog Out 4	↓
33	AOfref	Analog Out Reference	↑
34	B1	Digital B 1	↕
35	B3	Digital B 3	↕
36	B5	Digital B 5	↕
37	B7	Digital B 7	↕

Note: Direction is Computer relative Device.

Contributor: Joakim Ögren <qtech@mailhost.net>

BETA RELEASE

Sources: BeBox GeekPort DeviceKit <http://www.be.com/documentation/be_book/DeviceKit/geek.html> at Be's homepage <<http://www.be.com>>

Sources: BeBox GeekPort DeviceKit: Analog port
<http://www.be.com/documentation/be_book/DeviceKit/A2D2A.html>

Sources: BeBox GeekPort DeviceKit: Digital port
<http://www.be.com/documentation/be_book/DeviceKit/DPort.html>

Please send any comments to Joakim Ögren <qtech@mailhost.net>.

The Hardware Book is freely distributable but is copyrighted to Joakim Ögren. It may not be modified and re-distributed without the authors permission.

PRELIMINARY BETA. NOT FOR REDISTRIBUTION.

BETA RELEASE

C64/C16/C116/+4 Serial I/O

Available on the Commodore C64, C16, C116 and +4 computers.

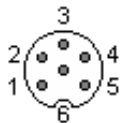

(At the computer)

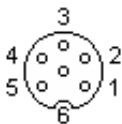

(At the cable)

6 PIN DIN (DIN45322) FEMALE at the Computer.

6 PIN DIN (DIN45322) MALE at the Cable.

Pin Name	Description
1	/SRQIN Serial SRQIN
2	GND Ground
3	ATN Serial ATN In/Out
4	CLK Serial CLK In/Out
5	DATA Serial DATA In/Out
6	/RESET Reset

Contributor: Joakim Ögren <qtech@mailhost.net>, Arwin Vosselman <0vosselman01@flnet.nl>

Source: SAMS Computerfacts CC8 Commodore 16.

Please send any comments to Joakim Ögren <qtech@mailhost.net>.

Atari ACSI DMA

Used to connect Laser printers or Harddrives.

NOT

DRAWN

YET...



(At the Computer)

NOT

DRAWN

YET...



(At the Devices)

19 PIN D-SUB ?? at the Computer.

19 PIN D-SUB ?? at the Devices.

Pin Name Description

1	D0	Data 0
2	D1	Data 1
3	D2	Data 2
4	D3	Data 3
5	D4	Data 4
6	D5	Data 5
7	D6	Data 6
8	D7	Data 7
9	/CS	Chip Select
10	IRQ	Interrupt Request
11	GND	Ground
12	/RST	Reset
13	GND	Ground
14	ACK	Acknowledge
15	GND	Ground
16	A1	?
17	GND	Ground
18	R/W	Read/Write
19	REQ	Data Request

Contributor: Joakim Ögren <qtech@mailhost.net>, Lawrence Wright <lwright@silk.net>, Steve & Sally Blair <blair@mailbox.uq.edu.au>

Source: ?

Please send any comments to Joakim Ögren <qtech@mailhost.net>.

VGA (VESA DDC)

VGA=Video Graphics Adapter or Video Graphics Array.
 VESA=Video Electronics Standards Association.
 DDC=Display Data Channel.

Videotype: Analogue.

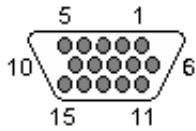

(At the videocard)

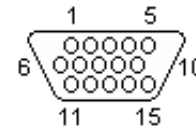

(At the monitor cable)

15 PIN HIGHDENSITY D-SUB FEMALE at the videocard.
 15 PIN HIGHDENSITY D-SUB MALE at the monitor cable.

Pin Name	Dir	Description
1 RED	→	Red Video (75 ohm, 0.7 V p-p)
2 GREEN	→	Green Video (75 ohm, 0.7 V p-p)
3 BLUE	→	Blue Video (75 ohm, 0.7 V p-p)
4 RES	-	Reserved
5 GND	—	Ground
6 RGND	—	Red Ground
7 GGND	—	Green Ground
8 BGND	—	Blue Ground
9 +5V	→	+5 VDC
10 SGND	—	Sync Ground
11 ID0	←	Monitor ID Bit 0 (optional)
12 SDA	↔	DDC Serial Data Line
13 HSYNC or CSYNC	→	Horizontal Sync (or Composite Sync)
14 VSYNC	→	Vertical Sync
15 SCL	↔	DDC Data Clock Line

Note: Direction is Computer relative Monitor.

Contributor: Joakim Ögren <qtech@mailhost.net>

Source: ?

Please send any comments to Joakim Ögren <qtech@mailhost.net>.

VGA (15)

VGA=Video Graphics Adapter or Video Graphics Array.
Videotype: Analogue.

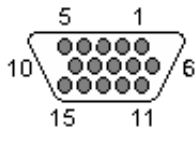

(At the videocard)

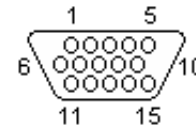

(At the monitor cable)

15 PIN HIGHDENSITY D-SUB FEMALE at the videocard.
15 PIN HIGHDENSITY D-SUB MALE at the monitor cable.

Pin Name	Dir	Description
1 RED	→	Red Video (75 ohm, 0.7 V p-p)
2 GREEN	→	Green Video (75 ohm, 0.7 V p-p)
3 BLUE	→	Blue Video (75 ohm, 0.7 V p-p)
4 ID2	↑	Monitor ID Bit 2
5 GND		Ground
6 RGND		Red Ground
7 GGND		Green Ground
8 BGND		Blue Ground
9 KEY	-	Key (No pin)
10 SGND		Sync Ground
11 ID0	↑	Monitor ID Bit 0
12 ID1 or SDA	↑	Monitor ID Bit 1
13 HSYNC or CSYNC	→	Horizontal Sync (or Composite Sync)
14 VSYNC	→	Vertical Sync
15 ID3 or SCL	↑	Monitor ID Bit 3

Note: Direction is Computer relative Monitor.

Contributor: Joakim Ögren <qtech@mailhost.net>

Source: ?

Please send any comments to Joakim Ögren <qtech@mailhost.net>.

VGA (9)

VGA=Video Graphics Adapter or Video Graphics Array.
Videotype: Analogue.

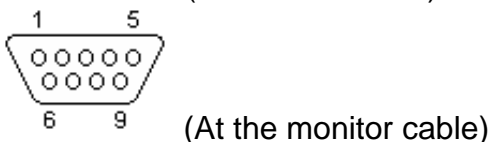
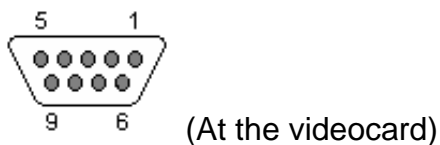

9 PIN D-SUB FEMALE at the videocard.
9 PIN D-SUB MALE at the monitor cable.

Pin Name	Dir	Description
1 RED	→	Red Video
2 GREEN	→	Green Video
3 BLUE	→	Blue Video
4 HSYNC	→	Horizontal Sync
5 VSYNC	→	Vertical Sync
6 RGND	—	Red Ground
7 GGND	—	Green Ground
8 BGND	—	Blue Ground
9 SGND	—	Sync Ground

Note: Direction is Computer relative Monitor.

Contributor: Joakim Ögren <qtech@mailhost.net>

Source: ?

Please send any comments to Joakim Ögren <qtech@mailhost.net>.

CGA

CGA=Color Graphics Adapter.
 Videotype: TTL, 16 colors.
 Also known as IBM RGBI.

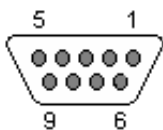

(At the videocard)

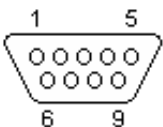

(At the monitor cable)

9 PIN D-SUB FEMALE at the videocard.
 9 PIN D-SUB MALE at the monitor cable.

Pin Name	Description
1	GND Ground
2	GND Ground
3	R Red
4	G Green
5	B Blue
6	I Intensity
7	RES Reserved
8	HSYNC Horizontal Sync
9	VSYNC Vertical Sync

Contributor: Joakim Ögren <qtech@mailhost.net>

Source: ?

Please send any comments to Joakim Ögren <qtech@mailhost.net>.

EGA

EGA=Enhanced Graphics Adapter.
Videotype: TTL, 16/64 colors.

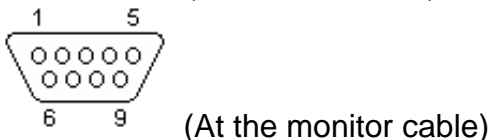
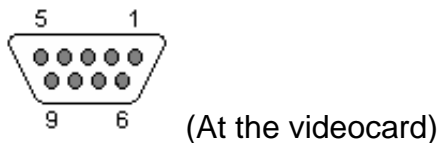

9 PIN D-SUB FEMALE at the videocard.
9 PIN D-SUB MALE at the monitor cable.

Pin Name Description

1	GND	Ground
2	SR	Secondary Red
3	PR	Primary Red
4	PG	Primary Green
5	PB	Primary Blue
6	SG/I	Secondary Green / Intensity
7	SB	Secondary Blue
8	H	Horizontal Sync
9	V	Vertical Sync

Contributor: Joakim Ögren <qtech@mailhost.net>

Source: ?

Please send any comments to Joakim Ögren <qtech@mailhost.net>.

PGA

Videotype: Analogue.

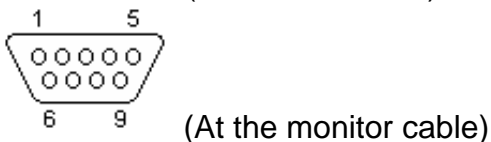
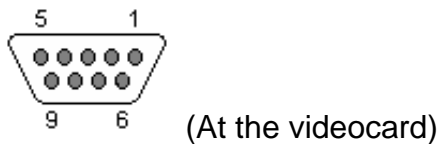

9 PIN D-SUB FEMALE at the videocard.

9 PIN D-SUB MALE at the monitor cable.

Pin Name	Description
1 R	Red
2 G	Green
3 B	Blue
4 CSYNC	Composite Sync
5 MODE	Mode Control
6 RGND	Red Ground
7 GGND	Green Ground
8 BGND	Blue Ground
9 GND	Ground

Contributor: Joakim Ögren <qtech@mailhost.net>

Source: ?

Please send any comments to Joakim Ögren <qtech@mailhost.net>

MDA (Hercules)

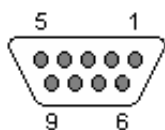

(At the videocard)

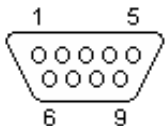

(At the monitor cable)

9 PIN D-SUB FEMALE at the videocard.
9 PIN D-SUB MALE at the monitor cable.

Pin Name Description

1	GND	Ground
2	GND	Ground
3	n/c	
4	n/c	
5	n/c	
6	I	Intensity
7	M	Mono Video
8	H	Horizontal Sync
9	V	Vertical Sync

Contributor: Joakim Ögren <qtech@mailhost.net>

Source: ?

Please send any comments to Joakim Ögren <qtech@mailhost.net>.

VESA Feature

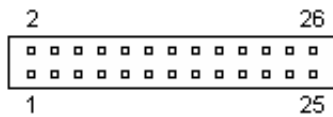

(At the videocard)

26 PIN IDC at the Video card.

Pin Name	Description
1	PD0 DAC Pixel Data Bit 0 (PB)
2	PD1 DAC Pixel Data Bit 1 (PG)
3	PD2 DAC Pixel Data Bit 2 (PR)
4	PD3 DAC Pixel Data Bit 3 (PI)
5	PD4 DAC Pixel Data Bit 4 (SB)
6	PD5 DAC Pixel Data Bit 5 (SG)
7	PD6 DAC Pixel Data Bit 6 (SR)
8	PD7 DAC Pixel Data Bit 7 (SI)
9	CLK DAC Clock
10	BLK DAC Blanking
11	HSYNC Horizontal Sync
12	VSYNC Vertical Sync
13	GND Ground
14	GND Ground
15	GND Ground
16	GND Ground
17	Select Internal Video
18	Select Internal Sync
19	Select Internal Dot Clock
20	n/c Not used
21	GND Ground
22	GND Ground
23	GND Ground
24	GND Ground
25	n/c Not used
26	n/c Not used

Contributor: Joakim Ögren <qtech@mailhost.net>

Source: ?

Please send any comments to Joakim Ögren <qtech@mailhost.net>.

Macintosh Video

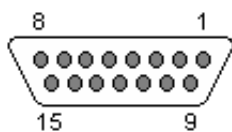

(At the Computer)

15 PIN D-SUB FEMALE at the Computer.

Pin	Pin Name	Dir	Description
1	RGND	—	Red Ground
2	R	→	Red
3	CSYNC	→	Composite sync
4	SENSE0	←	Monitor Sense 0
5	G	→	Green
6	GGND	—	Green Ground
7	SENSE1	←	Monitor Sense 1
8	n/c	-	No connection
9	B	→	Blue
10	SENSE2	←	Monitor sense 2
11	SGND	—	Sync Ground
12	VSYNC	→	Vertical Sync
13	BGND	—	Blue Ground
14	HSYNCGND	—	Horizontal Sync Ground
15	HSYNC	→	Horizontal Sync

Note: Direction is Computer relative Monitor.

Contributor: Joakim Ögren <qtech@mailhost.net>

Source: Tommy's pinout Collection <<http://csgrad.cs.vt.edu/~tjohnson/pinouts>> by Tommy Johnson <tjohnson@csgrad.cs.vt.edu>

Please send any comments to Joakim Ögren <qtech@mailhost.net>.

Amiga Video

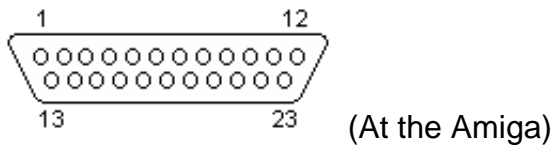

23 PIN D-SUB MALE at the Amiga.

Pin	Name	Dir	Description
1	/XCLK	←	Extern Clock
2	/XCLKEN	←	Extern Clock Enable (47 Ohm)
3	RED	→	Analog Red (75 Ohm)
4	GREEN	→	Analog Green (75 Ohm)
5	BLUE	→	Analog Blue (75 Ohm)
6	DI	→	Digital Intensity (47 Ohm)
7	DR	→	Digital Red (47 Ohm)
8	DG	→	Digital Green (47 Ohm)
9	DB	→	Digital Blue (47 Ohm)
10	/CSYNC	→	Composite Sync (47 Ohm)
11	/HSYNC	→	Horizontal Sync (47 Ohm)
12	/VSYNC	→	Vertical Sync (47 Ohm)
13	GNDRTN	—	Digital Ground (for /XCLKEN) Don't connect with pin 16-20.
14	/PIXELSW	→	Genlock overlay (47 Ohm)
15	/C1	→	Clock out (47 Ohm)
16	GND	—	Video Ground
17	GND	—	Video Ground
18	GND	—	Video Ground
19	GND	—	Video Ground
20	GND	—	Video Ground
21	-12V	→	-12 Volts DC (10 mA max) (A500/A600/A1200)
	-5V	→	-5 Volts DC (10 mA max) (A1000/A2000/A3000/A4000)
22	+12V	→	+12 Volts DC (100 mA max)
23	+5V	→	+5 Volts DC (100 mA max)

Note: Direction is Computer relative Monitor.

Contributor: Joakim Ögren <qtech@mailhost.net>

Source: Amiga 4000 User's Guide from Commodore

Please send any comments to Joakim Ögren <qtech@mailhost.net>.

Amiga 1000 RF Monitor



(At the computer)

8 PIN DIN "C" FEMALE at the computer.

Pin	Pin Name	Dir	Description
1	n/c	-	Not connected
2	GND	—	Ground
3	AUDL	→	Audio Left
4	CVIDEO	→	Composite Video
5	GND	—	Ground
6	n/c	-	Not connected
7	+12V	→	+12 VDC
8	AUDR	→	Audio Right

*Note: Direction is Computer relative Monitor.**Contributor: Joakim Ögren <qtech@mailhost.net>**Source: ?**Please send any comments to Joakim Ögren <qtech@mailhost.net>.*

CDTV Video Slot

```

  2  4  6  8 10 12 14 16 18 20 22 24 26 28 30
  --- --- --- --- --- --- --- --- --- --- --- --- --- --- ---
  1  3  5  7  9 11 13 15 17 19 21 24 25 27 29

```

```

  ?  ?  ?
  ?  ?  ?
  ?

```

(At the computer)

30 PIN ??? CONNECTOR at the computer.

Pin Name	Description	
1	GND	Video Ground
2	GND	Video Ground
3	XCLK	External Genlock Clock (in)
4	R	Red (in to video card)
5	/XCLKEN	Enables External Clock on XCLK.
6	BR	Buffered Red (out from video card)
7	GND	Video Ground
8	G	Green (in to video card)
9	GMS0	Genlock mode 0 (from computer, genlock button)
10	BG	Buffered Green (out from video card)
11	GMS1	Genlock mode 1 (from computer, genlock button)
12	B	Blue (in to video card)
13	/PIXELSW	Genlock signal
14	BB	Buffered Blue (out from video card)
15	VSYNC	Vertical Sync (in to video card)
16	CSYNC	Horizontal Sync (in to video card)
17	HSYNC	Composite Sync (in to video card)
18	BCSYNC	Buffered Composite Sync (out from video card)
19	GND	Video Ground
20	AUDR	Audio Right Output (from computer to RF modulator)
21	DGND	Digital Ground
22	AUDL	Audio Left Output (from computer to RF modulator)
23	-12V	-12 VDC (can be -5 VDC instead)
24	DGND	Digital Ground
25	+12V	+12 VDC
26	/CD/TV	CD/TV button. (Low=CDTV video on RF, High=Antenna)
27	VCC	+5 VDC
28	/CCK	3.58 MHz color clock (C1 clock)
29	GND	Video Ground
30	VCC	+5 VDC

Note: Used for RF-modulator usually.

Contributor: Joakim Ögren <qtech@mailhost.net>

Source: Darren Ewaniuk's CDTV Technical Information
<<http://nyquist.ee.ualberta.ca/~ewaniu/cdtv/cdtv-technical.html>>

Please send any comments to Joakim Ögren <qtech@mailhost.net>.

PlayStation A/V

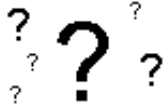
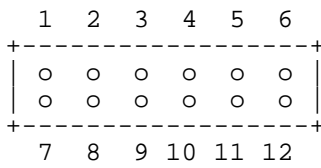

(At the PlayStation)

12 PIN ?? at the PlayStation.

Pin Name	Description
1	?
2	?
3	?
4	?
5	B Blue
6	R Red
7	?
8	AR Right Audio
9	CSYNC Composite Sync
10	VGND Video Ground
11	?
12	G Green

Contributor: Joakim Ögren <qtech@mailhost.net>

Source: Sony PlayStation FAQ <<http://www.gla.ac.uk/~gkrx11/PSX/FAQ.html>>

Please send any comments to Joakim Ögren <qtech@mailhost.net>

Commodore 1084 & 1084S (Analog)

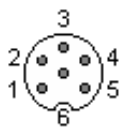

(At the Monitor)

6 PIN DIN FEMALE at the Monitor.

Pin Name	Description
1 G	Green
2 HSYNC	Horizontal Sync
3 GND	Ground
4 R	Red
5 B	Blue
6 VSYNC	Vertical Sync

Contributor: Joakim Ögren <qtech@mailhost.net>

Source: National Amiga's C1084 page <<http://www.interlog.com/~gscott/t-1084.html>>

Please send any comments to Joakim Ögren <qtech@mailhost.net>.

Commodore 1084 & 1084S (Digital)



(At the Monitor)

8 PIN DIN 'C' FEMALE at the Monitor.

Pin Name	Description
1	n/c Not connected
2	R Red
3	G Green
4	B Blue
5	I Intensity
6	GND Ground
7	HSYNC Horizontal Sync
8	VSYNC Vertical Sync

Contributor: Joakim Ögren <qtech@mailhost.net>

Source: National Amiga's C1084 page <<http://www.interlog.com/~gscott/t-1084.html>>

Please send any comments to Joakim Ögren <qtech@mailhost.net>.

Commodore 1084d & 1084dS

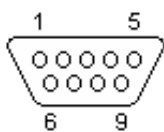

(At the Monitor)

9 PIN D-SUB FEMALE at the Monitor.

Pin Name	Analog Mode	Digital Mode
1 GND	Ground	Ground
2 GND	Ground	Ground
3 R	Red	Red
4 G	Green	Green
5 B	Blue	Blue
6 I	n/c	Intensity
7 CSYNS	Composite Sync	n/c
8 HSYNC	n/c	Horizontal Sync
9 VSYNC	n/c	Vertical Sync

Contributor: Joakim Ögren <qtech@mailhost.net>

Source: National Amiga's C1084d page <<http://www.interlog.com/~gscott/t-1084d.html>>

Please send any comments to Joakim Ögren <qtech@mailhost.net>.

Atari Jaguar A/V

TOP (duh)

1A 2A 3A 4A 5A 6A 7A 8A 9A 10A 11A 12A
 1B 2B 3B 4B 5B 6B 7B 8B 9B 10B 11B 12B

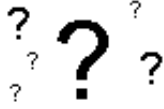

(At the Atari)

12 PIN ?? at the Atari.

Pin	Name	Description
1A	AL	Audio Left
2A	AGND	Audio Ground
3A	GND	Ground
4A	GND (chroma)	Ground (Chroma)
5A	B	RGB Blue
6A	HSYNC	Horizontal sync
7A	G	RGB Green
8A	CHROMA	Chroma
9A	GND ???	Ground ???
10A	+5V ???	+5 VDC ???
11A	+5V ???	+5 VDC ???
12A	?	?
1B	AR	Right audio
2B	AGND	Audio GND
3B	GND	Ground
4B	R	RGB Red
5B	CSYNC	Composite (Vertical) Sync
6B	?	?
7B	LGND	Luminance Ground
8B	LUM	Luminance
9B	GND	Ground
10B	CVBSGND	Composite Video Ground
11B	CVBS	Composite Video
12B	?	?

Contributor: Joakim Ögren <qtech@mailhost.net>

Source: Scooping out Jaguar RGB by Duncan Brown <BROWN_DU@Eisner.DECUS.Org> in Atari Explorer Online Vol.3 Issue 6 <http://www.redsun.net/jaguar/aeo/aeo_0306.txt>

Please send any comments to Joakim Ögren <qtech@mailhost.net>.

SNES Video

Available on the Nintendo SNES.

11	9	7	5	3	1
12	10	8	6	4	2

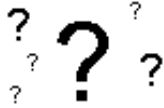

(At the SNES)

UNKNOWN CONNECTOR at the SNES.

Pin Name	Description
1 R	Red (Requires 200 uF in serie)
2 G	Green (Requires 200 uF in serie)
3 CSYNC	Composite Sync
4 B	Blue (Requires 200 uF in serie)
5 GND	Ground
6 GND	Ground
7 Y	S-Video Y
8 C	S-Video C
9 CVBS	Composite Video (NTSC)
10 +5V	+5 VDC
11 L+R	Left+Right Audio (Mono)
12 L-R	Left-Right Audio (Used to calculate Stereo)

Contributor: Joakim Ögren <qtech@mailhost.net>

Source: Video Games FAQ (Part 3)

<<http://www.lib.ox.ac.uk/internet/news/faq/archive/games.video-games.faq.part3.html>>, Pinout from Radio Electronics April 1992

Please send any comments to Joakim Ögren <qtech@mailhost.net>.

NeoGeo Audio/Video

Available on the NeoGeo videogame.

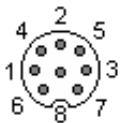

(At the Computer)

8 PIN DIN (DIN45326) FEMALE at the Computer.

Pin Name	Dir	Description
1	AOUT	Audio out
2	GND	Ground
3	VIDEO	Composite Video Out
4	+5V	+5 VDC
5	GREEN	Green Video
6	RED	Red Video
7	NSYNC	Negative Sync
8	BLUE	Blue Video

Note: Direction is Computer relative Monitor.

Contributor: Joakim Ögren <qtech@mailhost.net>, Enzo <enzo@gaiagnet.net>, Steffen Kupfer <Steffen_Kupfer@compuserve.com>

Source: ?

Please send any comments to Joakim Ögren <qtech@mailhost.net>.

Amstrad CPC6128 Monitor

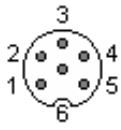

(At the computer)

6 PIN DIN (DIN45322) FEMALE at the computer.

Pin Name

- 1 RED
- 2 GREEN
- 3 BLUE
- 4 SYNC
- 5 GND
- 6 LUM

Contributor: Joakim Ögren <qtech@mailhost.net>, Agnello Guarracino <aggy@ooh.diron.co.uk>

Source: Amstrad CPC6128 User Instructions Manual

Please send any comments to Joakim Ögren <qtech@mailhost.net>.

PRELIMINARY BETA. NOT FOR REDISTRIBUTION.

Amstrad CPC6128 Plus Monitor



(At the computer)

8 PIN MINI-DIN FEMALE at the computer.

Pin	Name	Dir	Description
1	NSYNC	→	Sync?
2	GREEN	→	Green
3	LUM	→	Luminance
4	RED	→	Red
5	BLUE	→	Blue
6	AOL	→	Audio Output Left
7	AOR	→	Audio Output Right
8	GND	—	Ground

*Note: Direction is Computer relative Monitor.**Contributor: Joakim Ögren <qtech@mailhost.net>, Colin Gaunt <c.gaunt@c-gaunt.prestel.co.uk>**Source: Amstrad 6128 Plus Home Computer Manual**Please send any comments to Joakim Ögren <qtech@mailhost.net>.*

Atari ST Monitor

**NOT
DRAWN
YET...** 

(At the Computer)

**NOT
DRAWN
YET...** 

(At the Devices)

13 PIN DIN FEMALE at the Computer.
13 PIN DIN MALE at the Devices.

Pin Name	Description
1 AO	Audio Out
2 CVIDEO	Composite Video
3 CS	Clock Select
4 MD	Monochrome Detect / Clock In
5 AI	Audio In
6 G	Green
7 R	Red
8 +12V	+12 VDC (520ST has GND)
9 HSYNC	Horizontal Sync
10 B	Blue
11 MVIDEO	Monochrome Video
12 VSYNC	Vertical Sync
13 GND	Ground

Contributor: Joakim Ögren <qtech@mailhost.net>, Lawrence Wright <lwright@silk.net>, Steve & Sally Blair <blair@mailbox.uq.edu.au>

Source: ?

Please send any comments to Joakim Ögren <qtech@mailhost.net>.

Sun Video

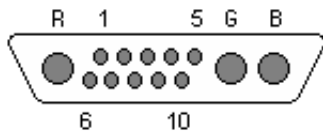

(At the Computer)

13 PIN 13W3 FEMALE at the Computer.

Pin Name	Description
1 GND	Ground*
2 VSYNC	Vertical Sync*
3 SENSE2	Sense #2
4 SENSEGND	Sense Ground
5 CSYNC	Composite Sync
6 HSYNC	Horizontal Sync*
7 GND	Ground*
8 SENSE1	Sense #1
9 SENSE0	Sense #0
10 CGND	Composite Ground
R RED	Red
G GREEN/GRAY	Green/Gray
B BLUE	Blue

*) Considered obsolete, may not be connected.

Monitor-sense bits defined as:

Value	Bit 2	Bit 1	Bit 0	Resolution
0	0	0	0	?
1	0	0	1	Reserved
2	0	1	0	1280 x 1024 76Hz
3	0	1	1	1152 x 900 66Hz
4	1	0	0	1152 x 900 76Hz 19"
5	1	0	1	Reserved
6	1	1	0	1152 x 900 76Hz 16-17"
7	1	1	1	No monitor connected

See <http://cvs.anu.edu.au:80/monitorconversion/>
[<http://cvs.anu.edu.au:80/monitorconversion/>](http://cvs.anu.edu.au:80/monitorconversion/) and
<http://rugmd0.chem.rug.nl/~everdij/hitachi.html>
[<http://rugmd0.chem.rug.nl/~everdij/hitachi.html>](http://rugmd0.chem.rug.nl/~everdij/hitachi.html) for info on attaching old workstation monitors to VGA boards.

Contributor: Joakim Ögren <qtech@mailhost.net>

Source: Tommy's pinout Collection <<http://csgrad.cs.vt.edu/~tjohnson/pinouts>> by Tommy Johnson <tjohnson@csgrad.cs.vt.edu>

Please send any comments to Joakim Ögren <qtech@mailhost.net>.

ZX Spectrun 128 RGB

Can be found at the Sinclair ZX Spectrum 128.

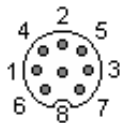

(At the computer)

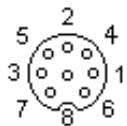

(At the monitor cable)

8 PIN DIN (DIN45326) FEMALE at the computer.

8 PIN DIN (DIN45326) MALE at the monitor cable.

Pin Name	Dir	Description
1 CVBS	→	Composite Video (PAL, 75 ohms, 1.2V p-p)
2 GND	→	Ground
3 BOUT	→	Bright Output
4 CSYNC	→	Composite Sync
5 VSYNC	→	Vertical Sync
6 G	→	Green
7 R	→	Red
8 B	→	Blue

Note: Direction is Computer relative Monitor.

Contributor: Joakim Ögren <qtech@mailhost.net>

Source: Online ZX Spectrum 128 Manual Page 3

<<http://users.ox.ac.uk/~uzdm0006/Damien/speccy/128manua/sp128p03.html>>

Please send any comments to Joakim Ögren <qtech@mailhost.net>.

3b1/7300 Video

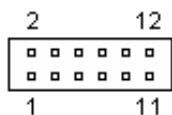

(At the computer)

12 PIN IDC MALE at the computer.

Pin Name	Description
1	VSYNC Vertical Sync
2	GND Ground
3	HSYNC Horizontal Sync
4	GND Ground
5	VIDEO Video
6	GND Ground
7	+12V +12 VDC
8	GND Ground
9	+12V +12 VDC
10	SPK Speaker
11	SPK Speaker
12	?

Contributor: Joakim Ögren <qtech@mailhost.net>

Source: Tommy's pinout Collection <<http://csgrad.cs.vt.edu/~tjohnson/pinouts>> by Tommy Johnson <tjohnson@csgrad.cs.vt.edu>

Please send any comments to Joakim Ögren <qtech@mailhost.net>.

CM-8/CoCo RGB

Available on the Tandy/Radio Shack Color Computer (CoCo).

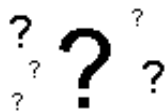
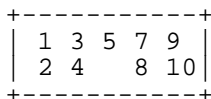

(At the CoCo)

UNKNOWN CONNECTOR at the CoCo.

Pin Name	Description
1 GND	Ground
2 GND	Ground
3 R	Red
4 G	Green
5 B	Blue
6 KEY	No Pin
7 AUDIO	Audio
8 HSYNC	Horizontal Sync
9 VSYNC	Vertical Sync
10 n/c	No Connection

Contributor: Joakim Ögren <qtech@mailhost.net>

Source: Tandy Color Computer FAQ <<http://www.io.com/~vga2000/faqs/coco.faq>> at Video Game Advantage's homepage <<http://www.io.com/~vga2000/>>

Please send any comments to Joakim Ögren <qtech@mailhost.net>

AT&T 53D410

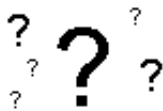

(At the computer)

25 PIN D-SUB ??? at the computer.

Pin Name	Description
1 ?	?
2 VSYNC	Vertical Sync
3 HSYNC	Horizontal Sync
4 ?	?
5 VIDEO	Video
6 ?	?
7 ?	?
8 ?	?
9 ?	?
10 ?	?
11 ?	?
12 ?	?
13 GND	Ground
14 GND	Ground
15 GND	Ground
16 ?	?
17 ?	?
18 ?	?
19 ?	?
20 ?	?
21 ?	?
22 ?	?
23 ?	?
24 ?	?
25 ?	?

Contributor: Joakim Ögren <qtech@mailhost.net>

Source: Tommy's pinout Collection <<http://csgrad.cs.vt.edu/~tjohnson/pinouts>> by Tommy Johnson <tjohnson@csgrad.cs.vt.edu>

Please send any comments to Joakim Ögren <qtech@mailhost.net>.

AT&T 6300 Taxan Monitor

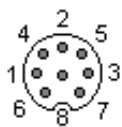

(At the Monitor)

8 PIN DIN (DIN45326) FEMALE at the Monitor.

Pin	Pin Name	Description
1	TEXT	Special TEXT signal (??)
2	R	Red
3	G	Green
4	B	Blue
5	I	Intensity
6	GND	Signal Ground
7	HSYNC/CSYNC	Horizontal or Composite Sync
8	VSYNC	Vertical Sync

Contributor: Joakim Ögren <qtech@mailhost.net>

Source: Tommy's pinout Collection <<http://csgrad.cs.vt.edu/~tjohnson/pinouts>> by Tommy Johnson <tjohnson@csgrad.cs.vt.edu>

Please send any comments to Joakim Ögren <qtech@mailhost.net>.

AT&T PC6300

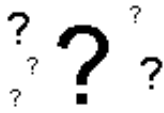

(At the computer)

25 PIN D-SUB ??? at the computer.

Pin Name	Description
1	HSYNC Horizontal Sync
2	ID0 Monitor ID 0
3	VSYNC Vertical Sync
4	R Red
5	G Green
6	B Blue
8	n/c Not connected
9	n/c Not connected
10	ID1 Monitor ID 1
11	MODE0 Mode 0
12	n/c Not connected
13	/DEGAUSS Degauss
14	GND Ground
15	GND Ground
16	GND Ground
17	GND Ground
18	GND Ground
19	GND Ground
20	GND Ground
21	GND Ground
22	n/c Not connected
23	n/c Not connected
24	+15V +15 VDC
25	+15V +15 VDC

Monochrome monitor: ID0 and ID1 are open

Color monitor: ID0 is 0, and ID1 is 1, probably 5V, not 15V

Contributor: Joakim Ögren <qtech@mailhost.net>

Source: Tommy's pinout Collection <<http://csgrad.cs.vt.edu/~tjohnson/pinouts>> by Tommy Johnson <tjohnson@csgrad.cs.vt.edu>

Please send any comments to Joakim Ögren <qtech@mailhost.net>.

Vic 20 Video

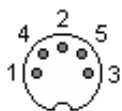

(At the computer)

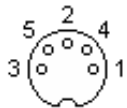

(At the cable)

5 PIN DIN 180° (DIN41524) FEMALE at the Computer.

5 PIN DIN 180° (DIN41524) MALE at the Cable.

Pin Name	Dir	Description
1	+6V	+6 VDC (10 mA max)
2	GND	Ground
3	AUDIO	Audio
4	VLOW	Video Low (Unconnected ?)
5	VHIGH	Video High

*Note: Direction is Computer relative Monitor.**Contributor: Joakim Ögren <qtech@mailhost.net>**Source: CBM Memorial Page Pinouts <http://www.vuse.vanderbilt.edu/~thompsbb/cbm_conn.txt>**Please send any comments to Joakim Ögren <qtech@mailhost.net>*

C64 Audio/Video

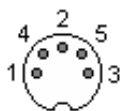

(At the computer)

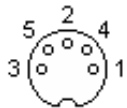

(At the cable)

5 PIN DIN 180° (DIN41524) FEMALE at the Computer.

5 PIN DIN 180° (DIN41524) MALE at the Cable.

Pin Name	Dir	Description
1	LUM →	Luminance
2	GND →	Ground
3	AOUT →	Audio Out
4	VOUT →	Video Out
5	AIN ←	Audio In

*Note: Direction is Computer relative Monitor.**Contributor: Joakim Ögren <qtech@mailhost.net>**Source: ?**Please send any comments to Joakim Ögren <qtech@mailhost.net>.*

C65 Video

Available on the Commodore C65 computer.

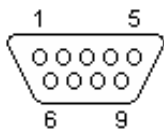

(At the Computer)

9 PIN D-SUB MALE at the Computer.

Pin	Name	Dir	Description
1	GND	—	Ground
2	?		?
3	R	→	Red
4	G	→	Green
5	B	→	Blue
6	?		?
7	CSYNC	→	Composite Sync
8	HSYNC	→	Horizontal Sync
9	VSNC	→	Vertical Sync

Note: Direction is Computer relative Monitor.

Contributor: Joakim Ögren <qtech@mailhost.net>

Source: CBM Memorial Page Pinouts <http://www.vuse.vanderbilt.edu/~thompsbb/cbm_conn.txt>

Please send any comments to Joakim Ögren <qtech@mailhost.net>.

C128 RGBI

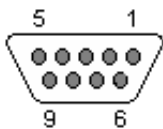

(At the Computer)

9 PIN D-SUB FEMALE at the Computer.

Pin	Name	Dir	Description
1	GND	—	Ground
2	GND	—	Ground
3	R	→	Red
4	G	→	Green
5	B	→	Blue
6	I	→	Intensity
7	VIDEO	→	Composite Video
8	HSYNC	→	Horizontal Sync
9	VSYNC	→	Vertical Sync

*Note: Direction is Computer relative Monitor.**Contributor: Joakim Ögren <qtech@mailhost.net>*

*Source: Usenet posting in comp.sys.cbm, C128 screen cables
<http://www.vuse.vanderbilt.edu/~thompsbb/cbm_conn.txt> by Marko Makela <msmakela@cc.helsinki.fi>*

Please send any comments to Joakim Ögren <qtech@mailhost.net>.

C128/C64C Video

Seems to be available on the C128 and the C64C (white colour). Compatible with cables for the 5 pin D-SUB on C64's.

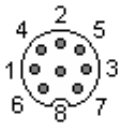

(At the Computer)

8 PIN DIN (DIN45326) FEMALE at the Computer.

Pin Name	Dir	Description
1	LUM	→ Luminance (monochrome video)
2	GND	→ Ground
3	AOUT	→ Audio out
4	VOUT	→ Composite Video out
5	AIN	← Audio in (into the SID chip)
6	n/c	- Not connected
7	n/c	- Not connected
8	C	→ Chroma

Note: Direction is Computer relative Monitor.

Contributor: Joakim Ögren <qtech@mailhost.net>

Source: CBM Memorial Page Pinouts <http://www.vuse.vanderbilt.edu/~thompsbb/cbm_conn.txt>

Please send any comments to Joakim Ögren <qtech@mailhost.net>.

C16/C116/+4 Audio/Video

Available on Commodore C16/C116/+4 computers.

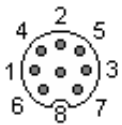

(At the Computer)

8 PIN DIN (DIN45326) FEMALE at the Computer.

Pin Name	Dir	Description
1 LUM	→	Luminance (monochrome video)
2 GND	→	Ground
3 AOUT	→	Audio out
4 VOUT	→	Composite Video out
5 AIN	←	Audio in (into the SID chip)
6 COLOR -	-	Color ?
7 n/c	-	Not connected
8 +5VDC	→	+5 VDC

Note: Direction is Computer relative Monitor.

Contributor: Joakim Ögren <qtech@mailhost.net>, Arwin Vosselman <0vosselman01@flnet.nl>

Sources: CBM Memorial Page Pinouts <http://www.vuse.vanderbilt.edu/~thompsbb/cbm_conn.txt>

Sources: SAMS Computerfacts CC8 Commodore 16.

Please send any comments to Joakim Ögren <qtech@mailhost.net>.

CBM 1902A

Available on the Commodore CBM 1902A monitor.

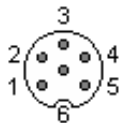

(At the Monitor)

6 PIN DIN FEMALE at the Monitor.

Pin	Name	Dir	Description
1	n/c	-	Not connected
2	AUDIO	←	Audio
3	GND	—	Ground
4	C	←	Chroma
5	n/c	-	Not connected
6	L	←	Luminance

Note: Direction is Monitor relative Computer.

Contributor: Joakim Ögren <qtech@mailhost.net>

Source: comp.sys.cbm General FAQ v3.1 Part 7
<<http://www.lib.ox.ac.uk/internet/news/faq/archive/cbm-main-faq.3.1.p7.html>>

Please send any comments to Joakim Ögren <qtech@mailhost.net>.

PRELIMINARY BETA. NOT FOR REDISTRIBUTION.

Spectravideo SVI318/328 Audio/Video

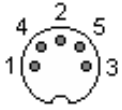

(At the computer)

5 PIN DIN 180° (DIN41524) FEMALE at the computer.

Pin Name	Description
1	+5v Power
2	GND System ground
3	AUDIO Audio out
4	VIDEO Composite Video out
5	RF VID RF Video out

Contributer: Rob Gill <gillz@mpx.com.au>

Source: Spectravideo SVI 328 mk II User Manual

Please send any comments to Joakim Ögren <qtech@mailhost.net>.

PRELIMINARY BETA. NOT FOR REDISTRIBUTION.

PC Gameport

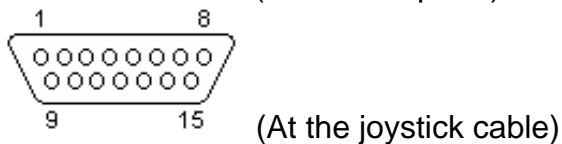
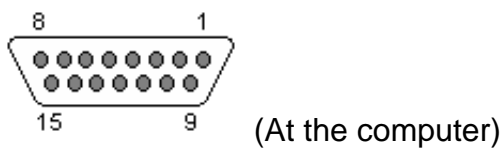

15 PIN D-SUB FEMALE at the computer.
15 PIN D-SUB MALE at the joystick cable.

Pin	Name	Dir	Description
1	+5V	→	+5 VDC
2	/B1	←	Button 1
3	X1	←	Joystick 1 - X
4	GND	—	Ground
5	GND	—	Ground
6	Y1	←	Joystick 1 - Y
7	/B2	←	Button 2
8	+5V	→	+5 VDC
9	+5V	→	+5 VDC
10	/B4	←	Button 4
11	X2	←	Joystick 2 - X
12	GND	—	Ground
13	Y2	←	Joystick 2 - Y
14	/B3	←	Button 3
15	+5V	→	+5 VDC

Note: Direction is Computer relative Joystick.

Note: Use 100kohm resistor.

Contributor: Joakim Ögren <qtech@mailhost.net>

Source: ?

Please send any comments to Joakim Ögren <qtech@mailhost.net>.

PC Gameport+MIDI

Some soundcards have some MIDI signals included in their Gameport. Ground and VCC has been used for this.

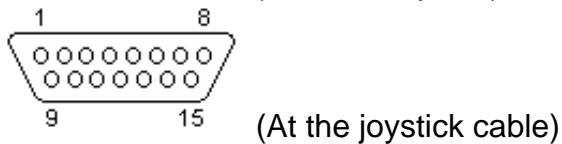
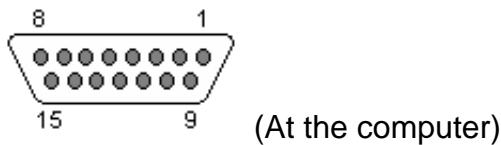

15 PIN D-SUB FEMALE at the computer.
15 PIN D-SUB MALE at the joystick cable.

Pin	Name	Dir	Description
1	+5V	→	+5 VDC
2	/B1	↑	Button 1
3	X1	↑	Joystick 1 - X
4	GND		Ground
5	GND		Ground
6	Y1	↑	Joystick 1 - Y
7	/B2	↑	Button 2
8	+5V	→	+5 VDC
9	+5V	→	+5 VDC
10	/B4	↑	Button 4
11	X2	↑	Joystick 2 - X
12	MIDITXD	→	MIDI Transmit
13	Y2	↑	Joystick 2 - Y
14	/B3	↑	Button 3
15	MIDIRXD	←	MIDI Receive

Note: Direction is Computer relative Joystick.

Note: Use 100kohm resistor.

Contributor: Joakim Ögren <qtech@mailhost.net>

Source: ?

Please send any comments to Joakim Ögren <qtech@mailhost.net>.

Amiga Mouse/Joy

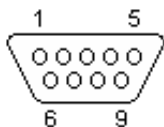

(At the computer)

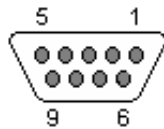

(At the mouse/joy cable)

9 PIN D-SUB MALE at the computer.

9 PIN D-SUB FEMALE at the mouse/joy cable.

Pin	Mouse/Trackball	Lightpen	Digital Joystick	Paddle	Dir	Comment
1	V-pulse	n/c	/FORWARD	BUTTON 3	↑	
2	H-pulse	n/c	/BACK	n/c	↑↑	
3	VQ-pulse	n/c	/LEFT	BUTTON 1	↑↑↑	
4	HQ-pulse	n/c	/RIGHT	BUTTON 2	↑↑↑↑	
5	BUTTON 3(M)	Penpress	n/c	PotX	↔↔	
6	BUTTON 1(L)	/Beamtrigger	/BUTTON 1	n/c	↔↔	
7	+5V	+5V	+5V	+5V	↓	50 mA max
8	GND	GND	GND	GND		
9	BUTTON 2(R)	BUTTON 2	BUTTON 2	PotY	↔↔	

*Note: Direction is Computer relative Device.**Note: Pot is a linear 470 kOhm ($\pm 10\%$)*

Contributor: Joakim Ögren <qtech@mailhost.net>

Source: Amiga 4000 User's Guide from Commodore

Please send any comments to Joakim Ögren <qtech@mailhost.net>.

C64 Control Port

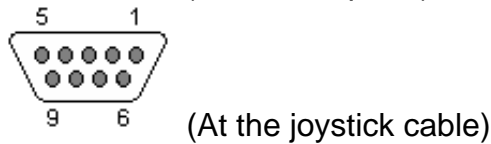
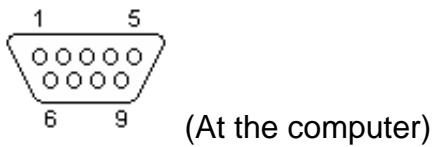

9 PIN D-SUB MALE at the computer.

9 PIN D-SUB FEMALE at the joystick cable.

Control Port 1

Pin	Name	Dir	Comment
1	JOYA0	↑	
2	JOYA1	↑	
3	JOYA2	↑	
4	JOYA4	↑	
5	POT AY	↕	
6	BUTTON A/LP	↕	
7	+5V	↓	50 mA max
8	GND		
9	POT AX	↕	

Control Port 2

Pin	Name	Dir	Comment
1	JOYB0	↑	
2	JOYB1	↑	
3	JOYB2	↑	
4	JOYB4	↑	
5	POT BY	↕	
6	BUTTON B	↕	
7	+5V	↓	50 mA max
8	GND		
9	POT BX	↕	

Note: Direction is Computer relative Device.

Note: Pot is a linear 470 kOhm ($\pm 10\%$)

Contributor: Joakim Ögren <qtech@mailhost.net>, Arwin Vosselman <0vosselman01@flnet.nl>

Sources: Amiga 4000 User's Guide from Commodore

Sources: Commodore 64 Programmer's Reference Guide

Please send any comments to Joakim Ögren <qtech@mailhost.net>.

C16/C116/+4 Joystick

Available on the Commodore C16, C116 and +4 computers.

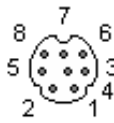

(At the computer)

8 PIN MINI-DIN FEMALE at the computer.

Joystick 1

Pin	Name	Dir	Comment
1	JOYA0	↑	
2	JOYA1	↑	
3	JOYA2	↑	
4	JOYA3	↑	
5	+5VDC	↓	
6	BUTTON A	?	
7	GND	—	
8	COMMON A	?	Is connected to DATA2 thru a buffer.

Joystick 2

Pin	Name	Dir	Comment
1	JOYB0	↑	
2	JOYB1	↑	
3	JOYB2	↑	
4	JOYB3	↑	
5	+5VDC	↓	
6	BUTTON B	?	
7	GND	—	
8	COMMON B	?	Is connected to DATA1 thru a buffer.

Note: Direction is Computer relative Device.

Contributor: Joakim Ögren <qtech@mailhost.net>, Arwin Vosselman <0vosselman01@flnet.nl>

Source: SAMS Computerfacts CC8 Commodore 16.

Please send any comments to Joakim Ögren <qtech@mailhost.net>.

MSX Joystick

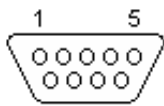

(At the computer)

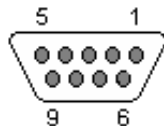

(At the joystick cable)

9 PIN D-SUB MALE at the computer.

9 PIN D-SUB FEMALE at the joystick cable.

Pin Name	Dir	Description
1 /FORWARD	←	Forward
2 /BACK	←	Backward
3 /LEFT	←	Left
4 /RIGHT	←	Right
5 +5V	→	+5 VDC (50mA max)
6 /TRG1	↔	Trigger A / Output 1
7 /TRG2	↔	Trigger A / Output 1
8 OUTPUT	→	Output 3
9 GND	—	Signal Ground

Note: Direction is Computer relative Joystick.

Warning: Pin 5 is +5V on MSX and Mouse Button 2 on Amiga. Since Amiga mousebutton is active low, connecting an Amiga mouse to a MSX and pressing mousebutton 2 will shortcut the supply voltage.

Contributor: Joakim Ögren <qtech@mailhost.net>

Source: Mayer's SV738 X'press I/O map <<http://www.freeflight.com/fms/MSX/Portar.txt>>

Please send any comments to Joakim Ögren <qtech@mailhost.net>.

SGI Mouse (Model 021-0004-002)

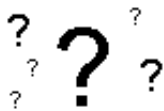

(At the Computer)

9 PIN D-SUB ??? at the Computer.

Pin Name	Dir	Description
1	+5V →	+5 VDC
2	-5V →	-5 VDC
3	n/c -	Not connected
4	n/c -	Not connected
5	MTXD ←	Data
6	n/c -	Not connected
7	n/c -	Not connected
8	n/c -	Not connected
9	GND —	Ground

*Note: Direction is Computer relative Mouse.**Contributor: Joakim Ögren <qtech@mailhost.net>**Source: Tommy's pinout Collection <<http://csgrad.cs.vt.edu/~tjohnson/pinouts>> by Tommy Johnson <tjohnson@csgrad.cs.vt.edu>**Please send any comments to Joakim Ögren <qtech@mailhost.net>.*

Macintosh Mouse

Available on Macintosh Mac Plus and earlier.

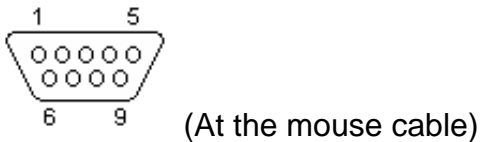
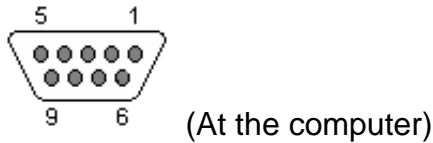

9 PIN D-SUB FEMALE at the computer.

9 PIN D-SUB MALE at the mouse cable.

Pin Name	Dir	Description
1	CGND	Chassis ground
2	+5V	+5 VDC
3	CGND	Chassis ground
4	X2	Horizontal movement line (connected to VIA PB4 line)
5	X1	Horizontal movement line (connected to SCC DCDA-line)
6	n/c	Not connected
7	SW-	Mouse button line (connected to VIA PB3)
8	Y2	Vertical movement line (connected to VIA PB5 line)
9	Y1	Vertical movement line (connected to SCC DCDB-line)

Note: Direction is Computer relative Mouse.

Contributor: Ben Harris <bjh@mail.dotcom.fr>

Source: Apple Tech Info Library, Article ID: TECHINFO-0001424

Please send any comments to Joakim Ögren <qtech@mailhost.net>.

Atari Mouse/Joy

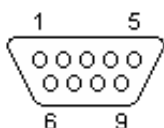

(At the computer)

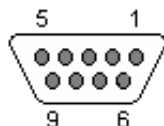

(At the mouse/joy cable)

9 PIN D-SUB MALE at the computer.

9 PIN D-SUB FEMALE at the mouse/joy cable.

Pin	Mouse	JoystickDir	Comment
1	XB	UP	←↑
2	XA	DOWN	←↓
3	YA	LEFT	←←
4	YB	RIGHT	←→
5	n/c	n/c	-
6	LEFTBUTTON	FIRE	←↑
7	+5V	+5V	←↓
8	GND	GND	←
9	RIGHTBUTTON	res	←↑

Note: Direction is Computer relative Device.

Contributor: Joakim Ögren <qtech@mailhost.net>, Steve & Sally Blair <blair@mailbox.uq.edu.au>

Source: ?

Please send any comments to Joakim Ögren <qtech@mailhost.net>.

Atari Enhanced Joystick

Can be found at Atari Falcon, Jaguar & STe.

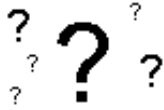

(At the computer)

UNKNOWN CONNECTOR at the computer.

Pin Name	Description
1 UP0	Up 0
2 DOWN0	Down 0
3 LEFT0	Left 0
4 RIGHT0	Right 0
5 PAD0Y	Paddle 0 Y
6 FIRE0/LIGHT GUN	Fire 0/Lightgun
7 VCC	+5 VDC
8 n/c	Not connected
9 GND	Ground
10 FIRE2	Fire 2
11 UP2	Up 2
12 DOWN2	Down 2
13 LEFT2	Left 2
14 RIGHT2	Right 2
15 PAD0X	Paddle 0 X

Contributor: Joakim Ögren <qtech@mailhost.net>

Source: Do-It-Yourself Atari Jaguar Controller <<http://dcpu1.cs.york.ac.uk:6666/~andrew/atari/DIYjoypad.txt>>
by Andrew Hague <andrew@minster.york.ac.uk>

Please send any comments to Joakim Ögren <qtech@mailhost.net>.

Atari 2600 Joystick

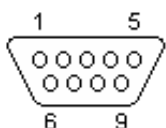

(At the Atari)

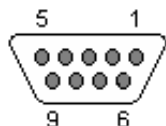

(At the joystick cable)

9 PIN D-SUB MALE at the Atari.

9 PIN D-SUB FEMALE at the joystick cable.

Pin	Color	Dir	Description
1	WHT	←	Up
2	BLU	←	Down
3	GRN	←	Left
4	BRN	←	Right
5	n/c	-	Not connected
6	ORG	←	Button
7	n/c	-	Not connected
8	BLK	—	Ground(-)
9	n/c	-	Not connected

*Note: Direction is Computer relative Joystick.**Note: Connect Direction/Button to Ground for action.*

Contributor: Joakim Ögren <qtech@mailhost.net>

Source: Classic Atari 2600/5200/7800 Game Systems FAQ

<<http://www.dhp.com/~sloppy/files/classic/atari/atari.faq>>, Pinout by Greg Alt <galt@cs.utah.edu>

Please send any comments to Joakim Ögren <qtech@mailhost.net>.

Atari 6200 Joystick

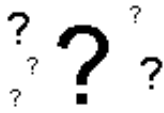

(At the Atari)

UNKNOWN CONNECTOR at the Atari.

Pin Description

- 1 Keypad -- right column
- 2 Keypad -- middle column
- 3 Keypad -- left column
- 4 Start, Pause, and Reset common
- 5 Keypad -- third row and Reset
- 6 Keypad -- second row and Pause
- 7 Keypad -- top row and Start
- 8 Keypad -- bottom row
- 9 Pot common
- 10 Horizontal pot (POT0, 2, 4, 6)
- 11 Vertical pot (POT1, 3, 5, 7)
- 12 5 volts DC
- 13 Bottom side buttons (TRIG0, 1, 2, 3)
- 14 Top side buttons
- 15 0 volts -- ground

Contributor: Joakim Ögren <qtech@mailhost.net>

Source: Classic Atari 2600/5200/7800 Game Systems FAQ
<<http://www.dhp.com/~sloppy/files/classic/atari/atari.faq>>

Please send any comments to Joakim Ögren <qtech@mailhost.net>.

Atari 7800 Joystick

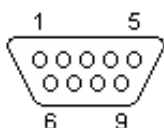

(At the Atari)

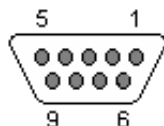

(At the joystick cable)

9 PIN D-SUB MALE at the Atari.

9 PIN D-SUB FEMALE at the joystick cable.

Pin	Color	Dir	Description
1	WHT	←	Up
2	BLU	←	Down
3	GRN	←	Left
4	BRN	←	Right
5	RED	←	Button (R)ight (-)
6	ORG	?	Both buttons (+)
7	n/c	-	Not connected
8	BLK	—	Ground(-)
9	YLW	←	Button (L)eft (-)

*Note: Direction is Computer relative Joystick.**Note: Connect Direction and Button(L/R) to Ground for action. And Both Button to Button L and Button R for action.*

Contributor: Joakim Ögren <qtech@mailhost.net>

Source: Classic Atari 2600/5200/7800 Game Systems FAQ
<<http://www.dhp.com/~sloppy/files/classic/atari/atari.faq>>

Please send any comments to Joakim Ögren <qtech@mailhost.net>.

Amstrad Digital Joystick

Available at the Amstrad CPC6128 and CPC6128 Plus.

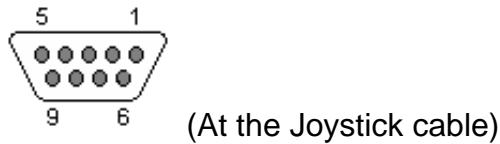
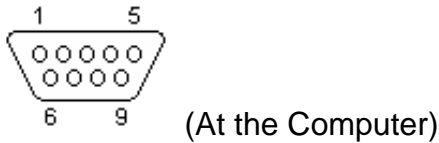

9 PIN D-SUB MALE at the Computer.

9 PIN D-SUB FEMALE at the Joystick cable.

Digital Joystick 1

Pin Name	Dir	Description
1	UP	Up
2	DOWN	Down
3	LEFT	Left
4	RIGHT	Right
5	n/c	- Not connected
6	FIRE2	Fire button 2
7	FIRE1	Fire button 1
8	GND	Ground
9	GND	Ground

Digital Joystick 2

Pin Name	Dir	Description
1	UP	Up
2	DOWN	Down
3	LEFT	Left
4	RIGHT	Right
5	n/c	- Not connected
6	FIRE2	Fire button 2
7	FIRE1	Fire button 1
8	GND	Ground
9	n/c	- Not connected

Note: Direction is Computer relative Joystick.

Contributor: Joakim Ögren <qtech@mailhost.net>, Colin Gaunt <c.gaunt@c-gaunt.prestel.co.uk>, Agnello Guarracino <aggy@ooh.diron.co.uk>

Source: Amstrad 6128 Plus Home Computer Manual
Source: Amstrad CPC6128 User Instructions Manual

Please send any comments to Joakim Ögren <qtech@mailhost.net>.

NeoGeo Joystick

Available on the NeoGeo videogame.

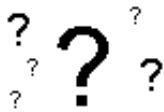

(At the Computer)

14 PIN CANNON (2 ROWS) ?? at the Computer.

Could anyone please tell me what kind of connector it has.

Pin Name	Dir	Description
1 GND	—	Ground
2 n/c	-	Not connected
3 SELECT	←	Select Button
4 BUTTOND	←	"D" Button
5 BUTTONB	←	"B" Button
6 RIGHT	←	Right
7 DOWN	←	Down
8 n/c	-	Not connected
9 BUTTOND	←	"D" Button, again?
10 n/c	-	Not connected
11 START	←	Start Button
12 BUTTONC	←	"C" Button
13 BUTTONA	←	"A" Button
14 LEFT	←	Left
15 UP	↑	Up

Note: Direction is Computer relative Joystick.

Contributor: Joakim Ögren <qtech@mailhost.net>, Enzo <enzo@gaiamet.net>

Source: ?

Please send any comments to Joakim Ögren <qtech@mailhost.net>.

Keyboard (5 PC)

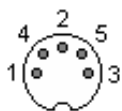

(At the computer)

5 PIN DIN 180° (DIN41524) FEMALE at the computer.

Pin Name	Description	Technical
1	CLOCK	Clock
2	DATA	Data
3	n/c	Not connected
4	GND	Ground
5	VCC	+5 VDC

Contributor: Joakim Ögren <qtech@mailhost.net>

Source: ?

Please send any comments to Joakim Ögren <qtech@mailhost.net>.

Keyboard (6 PC)



(At the computer)

6 PIN MINI-DIN FEMALE (PS/2 STYLE) at the computer.

Pin	Name	Dir	Description
1	DATA	↔	Key Data
2	n/c	-	Not connected
3	GND	—	Gnd
4	VCC	→	Power , +5 VDC
5	CLK	→	Clock
6	n/c	-	Not connected

Note: Direction is Computer relative Keyboard.

Contributor: Joakim Ögren <qtech@mailhost.net>, Gilles Ries <gries@glo.be>

Source: ?

Please send any comments to Joakim Ögren <qtech@mailhost.net>.

Keyboard (XT)

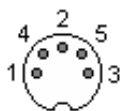

(At the computer)

5 PIN DIN 180° (DIN41524) FEMALE at the computer.

Pin Name	Description	Technical
1 CLK	Clock	CLK/CTS, Open-collector
2 DATA	Data	RxD, Open-collector
3 /RESET	Reset	
4 GND	Ground	
5 VCC	+5 VDC	

Contributor: Joakim Ögren <qtech@mailhost.net>

Source: ?

Please send any comments to Joakim Ögren <qtech@mailhost.net>.

PRELIMINARY BETA. NOT FOR REDISTRIBUTION.

Keyboard (5 Amiga)

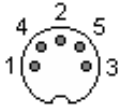

(At the computer)

5 PIN DIN 180° (DIN41524) FEMALE (A1000/A2000/A3000) at the computer.

Pin	A1000	A2000/A3000
1	+5 Volts	KCLK
2	CLOCK	KDAT
3	DATA	n/c
4	GND	GND
5		+5 Volts

Contributor: Joakim Ögren <qtech@mailhost.net>

Source: ?

Please send any comments to Joakim Ögren <qtech@mailhost.net>.

Keyboard (6 Amiga)



(At the computer)

6 PIN MINI-DIN FEMALE (PS/2 STYLE) (A4000/CD32/CDTV) at the computer.

Pin Name	Dir	Description
1	/DATA	↔ Data
2	n/c	- Not connected
3	GND	— Ground
4	+5V	→ +5 Volts DC (100 mA max)
5	CLOCK	← Clock
6	n/c	- Not connected

Note: Direction is Computer relative Keyboard.

Contributor: Joakim Ögren <qtech@mailhost.net>, Dirk Duesterberg <duesterb@unixserv.rz.fh-hannover.de>

Source: Amiga 4000 User's Guide from Commodore

Please send any comments to Joakim Ögren <qtech@mailhost.net>.

Keyboard (Amiga CD32)

The Amiga CD32 keyboard connector also includes a serialport.



(At the computer)

6 PIN MINI-DIN FEMALE (PS/2 STYLE) at the computer.

Pin Name	Dir	Description
1 /DATA	↔	Data
2 /TxD	→	Transmit Data (0-5V and reversed)
3 GND	—	Ground
4 +5V	→	+5 Volts DC (100 mA max)
5 CLOCK	←	Clock
6 /RxD	←	Receive Data (0-5V and reversed)

Note: Direction is Computer relative Keyboard.

Contributor: Joakim Ögren <qtech@mailhost.net>, Dirk Duesterberg <duesterb@unixserv.rz.fh-hannover.de>

Source: CD32 keyboard port info <ftp://ftp.demon.co.uk/pub/amiga/docs/cd32-pinouts.txt>, usenet posting by Klaus Hegemann <Klaus_Hegemann@punk.fido.de>.

Please send any comments to Joakim Ögren <qtech@mailhost.net>.

Macintosh Keyboard

Available on Macintosh Mac Plus and earlier.

NOT

DRAWN

YET...



(At the Computer)

NOT

DRAWN

YET...



(At the Keyboard)

RJ11 FEMALE CONNECTOR at the Computer.

RJ11 MALE CONNECTOR at the Keyboard.

Pin	Name	Dir	Description
1	CGND	—	Chassis ground
2	KBD1	?	Keyboard clock
3	KBD2	?	Keyboard data
4	+5V	→	+5 VDC

Note: Direction is Computer relative Keyboard.

Contributor: Ben Harris <bjh@mail.dotcom.fr>

Source: Apple Tech Info Library, Article ID: TECHINFO-0001424

Please send any comments to Joakim Ögren <qtech@mailhost.net>

AT&T 6300 Keyboard

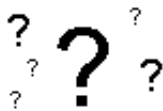

(At the Computer)

9 PIN D-SUB ??? at the Computer.

Pin Name	Description
1 DATA	Data
2 CLOCK	Clock
3 GND	Ground
4 GND	Ground
5 +12V	+12 VDC
6 n/c	Not connected
7 n/c	Not connected
8 n/c	Not connected
9 n/c	Not connected

Contributor: Joakim Ögren <qtech@mailhost.net>

Source: Tommy's pinout Collection <<http://csggrad.cs.vt.edu/~tjohnson/pinouts>> by Tommy Johnson <tjohnson@csggrad.cs.vt.edu>

Please send any comments to Joakim Ögren <qtech@mailhost.net>.

Internal Diskdrive

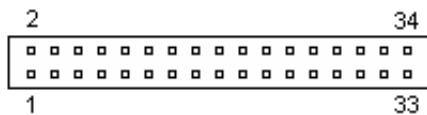

(At the computer & diskdrives)

34 PIN IDC MALE at the computer & diskdrives.

Pin Name	Dir	Description
2 /REDWC	→	Density Select
4 n/c		Reserved
6 n/c		Reserved
8 /INDEX	↑	Index
10 /MOTEA	→	Motor Enable A
12 /DRVSB	→	Drive Sel B
14 /DRVSA	→	Drive Sel A
16 /MOTEB	→	Motor Enable B
18 /DIR	→	Direction
20 /STEP	→	Step
22 /WDATE	→	Write Data
24 /WGATE	→	Floppy Write Enable
26 /TRK00	↑	Track 0
28 /WPT	↑	Write Protect
30 /RDATA	↑	Read Data
32 /SIDE1	→	Head Select
34 /DSKCHG	→	Disk Change

*Note: Direction is Computer relative Diskdrive.**Note: All odd pins are GND, Ground.**Note: Can be an Edge-connector on old PC's.*

Contributor: Joakim Ögren <qtech@mailhost.net>

Source: ?

Please send any comments to Joakim Ögren <qtech@mailhost.net>.

8" Floppy Diskdrive

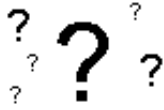

(At the computer)

50 PIN EDGE or IDC at the computer??.

Pin Name	Dir	Description
2 /REDWC	←	Reduced Write Current
4 n/c	-	Reserved
6 n/c	-	Reserved
8 n/c	-	Reserved
10 /FD2S	←	Disk is two sided
12 /DCG	←	Disk has been changed/door open
14 /SIDE	→	Side select
16 /DLOCK	→	Door lock
18 /HLD	→	Head load
20 /INDEX	←	Index Pulse
22 /READY	←	Ready
24 n/c	-	Not connected
26 /SEL1	←	Select Drive 1
28 /SEL2	←	Select Drive 2
30 /SEL3	←	Select Drive 3
32 /SEL4	←	Select Drive 4
34 /DIR	→	Direction
36 /STEP	→	Step
38 /WDAT	→	Write data
40 /WGAT	→	Write gate
42 /TR00	←	Track 00 (Zero)
44 /WPROT	←	Write protect
46 /RDATA	←	Read data
48 n/c	-	Not connected
50 n/c	-	Not connected

Note: Direction is Computer relative Diskdrive.

Note: All odd pins are GND, Ground.

Contributor: Joakim Ögren <qtech@mailhost.net>, Dennis Painter <dwp@rocketmail.com>

Source: ?

Please send any comments to Joakim Ögren <qtech@mailhost.net>.

Amiga External Diskdrive

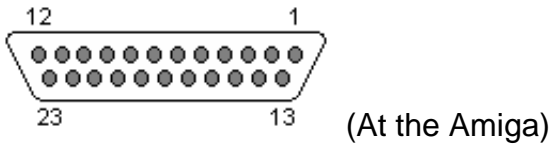

23 PIN D-SUB FEMALE at the Amiga.

Pin Name	Dir	Description
1 /RDY	↔	Disk Ready
2 /DKRD	←	Disk Read Data
3 GND	—	Ground
4 GND	—	Ground
5 GND	—	Ground
6 GND	—	Ground
7 GND	—	Ground
8 /MTRXD	OC	Disk Motor Control
9 /SEL2	OC	Select Drive 2
10 /DRES	OC	Disk Reset
11 /CHNG	↔	Disk Removed From Drive-Latched Low
12 +5V	→	+5 Volts DC (250 mA max)
13 /SIDE	→	Select Disk Side (0=Upper, 1=Lower)
14 /WPRO	↔	Disk is Write Protected
15 /TKO	↔	Drive Head position over Track 0
16 /DKWE	OC	Disk Write Enable
17 /DKWD	OC	Disk Write Data
18 /STEP	OC	Step the Head-Pulse, First low, then high
19 DIR	OC	Select Head Direction (0=Inner, 1=Outer)
20 /SEL3	OC	Select Drive 3
21 /SEL1	OC	Select Drive 1
22 /INDEX	OC	Disk Index Pulse
23 +12V	→	+12 Volts DC (160 mA max, 540 mA surge)

Note: Direction is Computer relative Diskdrive.

Contributor: Joakim Ögren <qtech@mailhost.net>

Source: Amiga 4000 User's Guide from Commodore

Please send any comments to Joakim Ögren <qtech@mailhost.net>.

MSX External Diskdrive

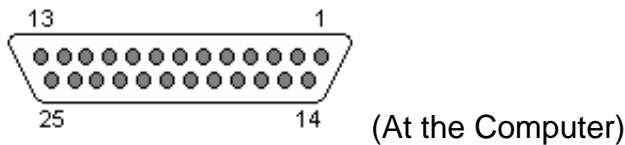

25 PIN D-SUB FEMALE at the Computer.

Pin Name	Dir	Description
1 +12V	→	+12 VDC
2 +5V	→	+5 VDC
3 +5V	→	+5 VDC
4 /INDEX	←	Sector hole passed sensor.
5 /DSEL1	→	Drive Select 1
6 DIR	→	Direction (0=In, 1=Dir)
7 /STEP	→	Moves head 1 step in DIR direction.
8 WRITEDATA	→	Write Data
9 /WRITEGATE	→	Write Gate
10 /TRACK00	←	Head is over Track 00 (outermost track)
11 /WRITEPROTECT	←	Write protected disk (0=Write protected)
12 READDATA	←	Data read from diskette.
13 /SIDESELECT	→	Side Select (0=Side 1, 1=Side 0)
14 +12V	→	+12 VDC
15 +12V	→	+12 VDC
16 +5V	→	+5 VDC
17 /DSEL1	→	Select Drive 0
18 /MOTOR	→	Motor On
19 READY	←	Ready
20 GND	—	Ground
21 GND	—	Ground
22 GND	—	Ground
23 GND	—	Ground
24 GND	—	Ground
25 GND	—	Ground

Note: Direction is Computer relative Diskdrive.

Contributor: Joakim Ögren <qtech@mailhost.net>

Source: Mayer's SV738 X'press I/O map <<http://www.freeflight.com/fms/MSX/Portar.txt>>

Please send any comments to Joakim Ögren <qtech@mailhost.net>.

Amstrad CPC6128 Diskdrive 2

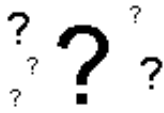

(At the computer)

34 PIN MALE EDGE at the computer.

Pin Name

1	READY
2	GND
3	SIDE 1 SELECT
4	GND
5	READ DATA
6	GND
7	WRITE PROTECT
8	GND
9	TRACK 0
10	GND
11	WRITE GATE
12	GND
13	WRITE DATA
14	GND
15	STEP
16	GND
17	DIRECTION SELECT
18	GND
19	MOTOR ON
20	GND
21	n/c
22	GND
23	DRIVE SELECT 1
24	GND
25	n/c
26	GND
27	INDEX
28	GND
29	n/c
30	GND
31	n/c
32	GND
33	n/c
34	GND

Contributor: Joakim Ögren <qtech@mailhost.net>, Agnello Guarracino <aggy@ooh.diron.co.uk>

Source: Amstrad CPC6128 User Instructions Manual

Please send any comments to Joakim Ögren <qtech@mailhost.net>.

Amstrad CPC6128 Plus External Diskdrive

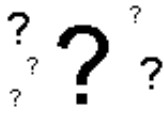

(At the Computer)

36 PIN D-SUB MALE at the Computer.

Pin	Name	Dir	Description
1	n/c	-	Not connected
3	n/c	-	Not connected
5	n/c	-	Not connected
7	NINDEX	?	
9	n/c	-	Not connected
11	NDSEL1	?	
13	n/c	-	Not connected
15	NMOTOR	?	
17	NDSEL	?	
19	NSTEP	→	Step head
21	NWDATA	→	Write Data
23	NWGATE	→	Write Gate
25	NTK00	←	Track 00
27	NWRPT	←	Write Protect
29	NRDDTA	←	Read Data
31	NSIDE1	?	
33	NREADY	?	
35	n/c		Not connected

*Note: Direction is Computer relative Diskdrive.**Note: All even pins are GND, Ground.*

Contributor: Joakim Ögren <qtech@mailhost.net>, Colin Gaunt <c.gaunt@c-gaunt.prestel.co.uk>

Source: Amstrad 6128 Plus Home Computer Manual

Please send any comments to Joakim Ögren <qtech@mailhost.net>.

Macintosh External Drive

**NOT
DRAWN
YET...** 

(At the Computer)

**NOT
DRAWN
YET...** 

(At the Diskdrive)

19 PIN D-SUB FEMALE at the Computer.

19 PIN D-SUB MALE at the Diskdrive.

Pin	Name	Dir	Description
1	CGND	—	Chassis ground
2	CGND	—	Chassis ground
3	CGND	—	Chassis ground
4	CGND	—	Chassis ground
5	-12V	→	-12 VDC
6	+5V	→	+5 VDC
7	+12V	→	+12 VDC
8	+12V	→	+12 VDC
9	n/c	-	Not connected
10	PWM	?	Regulates speed of the drive
11	CA0	?	Control line to send commands to the drive
12	CA1	?	Control line to send commands to the drive
13	CA2	?	Control line to send commands to the drive
14	LSTRB	?	Control line to send commands to the drive
15	WrReq-	?	Turns on the ability to write data to the drive
16	HdSel	?	Control line to send commands to the drive
17	Enbl2-	?	Enables the Rd line (else Rd is tristated)
18	Rd	←	Data actually read from the drive
19	Wr	→	Data actually written to the drive

Note: Direction is Computer relative Diskdrive.

Contributor: Ben Harris <bjh@mail.dotcom.fr>

Source: Apple Tech Info Library, Article ID: TECHINFO-0001424

Please send any comments to Joakim Ögren <qtech@mailhost.net>

Atari Floppy Port

NOT

DRAWN

YET...



(At the Computer)

NOT

DRAWN

YET...



(At the Diskdrive)

14 PIN DIN FEMALE at the Computer.

14 PIN DIN MALE at the Diskdrive.

Pin Name	Description
1 RD	Read Data
2 SIDE0	Side 0 Select
3 GND	Ground
4 INDEX	Index
5 SEL0	Drive 0 Select
6 SEL1	Drive 1 Select
7 GND	Ground
8 MOTOR	Motor On
9 DIR	Direction In
10 STEP	Step
11 WD	Write Data
12 WG	Write Gate
13 TRK00	Track 00
14 WP	Write Protect

Contributor: Joakim Ögren <qtech@mailhost.net>, Lawrence Wright <lwright@silk.net>, Steve & Sally Blair <blair@mailbox.uq.edu.au>

Source: ?

Please send any comments to Joakim Ögren <qtech@mailhost.net>.

SCSI Internal (Single-ended)

SCSI=Small Computer System Interface.

Based on an original design by Shugart Associates. SCSI was ratified in 1986.

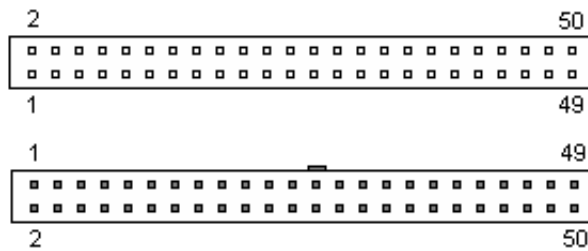

(At the controller & harddisk)

(At the cable.)

50 PIN IDC MALE at the controller & harddisk.

50 PIN IDC FEMALE at the cable.

Pin Name	Dir	Description
2 DB0	↔	Data Bus 0
4 DB1	↔	Data Bus 1
6 DB2	↔	Data Bus 2
8 DB3	↔	Data Bus 3
10 DB4	↔	Data Bus 4
12 DB5	↔	Data Bus 5
14 DB6	↔	Data Bus 6
16 DB7	↔	Data Bus 7
18 PARITY	↔	Data Parity (odd Parity)
20 GND		Ground
22 GND		Ground
24 GND		Ground
26 TMPWR	↔	Termination Power
28 GND		Ground
30 GND		Ground
32 /ATN	↑	Attention
34 GND		Ground
36 /BSY	↔	Busy
38 /ACK	↔	Acknowledge
40 /RST	↔	Reset
42 /MSG	↔	Message
44 /SEL	↔	Select
46 /C/D	↔	Control/Data
48 /REQ	↔	Request
50 /I/O	↔	Input/Output

Note: Direction is Device relative Bus (other Devices).

All odd-numbered pins, except pin 25, are connected to ground. Pin 25 is left open.

Contributor: Joakim Ögren <qtech@mailhost.net>

Source: ?

Please send any comments to Joakim Ögren <qtech@mailhost.net>.

SCSI Internal (Differential)

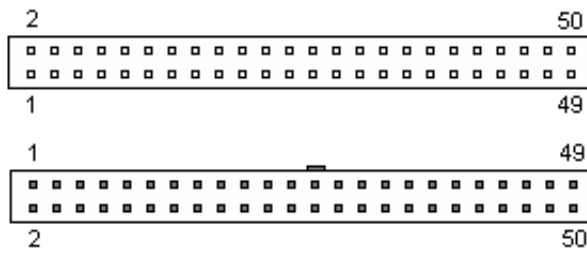







(at the controller & harddisk.)

(At the cable.)

50 PIN IDC MALE at the controller & harddisk.
50 PIN IDC FEMALE at the cable.

Pin	Name	Dir	Description
01	GND	—	Ground
02	GND	—	Ground
03	+DB0	↔	+Data Bus 0
04	-DB0	↔	-Data Bus 0
05	+DB1	↔	+Data Bus 1
06	-DB1	↔	-Data Bus 1
07	+DB2	↔	+Data Bus 2
08	-DB2	↔	-Data Bus 2
09	+DB3	↔	+Data Bus 3
10	-DB3	↔	-Data Bus 3
11	+DB4	↔	+Data Bus 4
12	-DB4	↔	-Data Bus 4
13	+DB5	↔	+Data Bus 5
14	-DB5	↔	-Data Bus 5
15	+DB6	↔	+Data Bus 6
16	-DB6	↔	-Data Bus 6
17	+DB7	↔	+Data Bus 7
18	-DB7	↔	-Data Bus Parity7
19	+DBP	↔	+Data Bus Parity (odd Parity)
20	-DBP	↔	-Data Bus Parity (odd Parity)
21	DIFFSENS	?	???
22	GND	—	Ground
23	res	-	Reserved
24	res	-	Reserved
25	TERMPWR	↔	Termination Power
26	TERMPWR	↔	Termination Power
27	res	-	Reserved
28	res	-	Reserved
29	+ATN	↑	+Attention
30	-ATN	↑	-Attention
31	GND	—	Ground
32	GND	—	Ground
33	+BSY	↔	+Bus is busy
34	-BSY	↔	-Bus is busy
35	+ACK	↑	+Acknowledge
36	-ACK	↑	-Acknowledge
37	+RST	↔	+Reset
38	-RST	↔	-Reset
39	+MSG	→	+Message
40	-MSG	→	-Message
41	+SEL	↔	+Select
42	-SEL	↔	-Select
43	+C/D	→	+Control or Data
44	-C/D	→	-Control or Data

BETA RELEASE

45	+REQ		+Request
46	-REQ		-Request
47	+I/O		+In/Out
48	-I/O		-In/Out
49	GND		Ground
50	GND		Ground

Note: Direction is Device relative Bus (other Devices).

Contributor: Joakim Ögren <qtech@mailhost.net>, Karsten Wenke <Karsten.Wenke@t-online.de>

Source: ?

Please send any comments to Joakim Ögren <qtech@mailhost.net>.

PRELIMINARY BETA. NOT FOR REDISTRIBUTION.

SCSI External Centronics 50 (Single-ended)

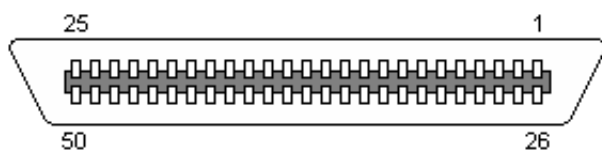

(At the controller & devices)

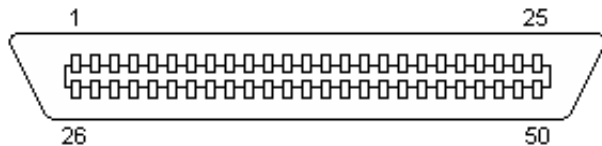

(At the cable)

50 PIN CENTRONICS FEMALE at the controller & devices.

50 PIN CENTRONICS MALE at the cable.

Pin	Name	Dir	Description
1-25	GND	—	Ground
26	DB0	↔	Data Bus 0
27	DB1	↔	Data Bus 1
28	DB2	↔	Data Bus 2
29	DB3	↔	Data Bus 3
30	DB4	↔	Data Bus 4
31	DB5	↔	Data Bus 5
32	DB6	↔	Data Bus 6
33	DB7	↔	Data Bus 7
34	PARITY	↔	Data Parity (odd Parity)
35	GND	—	Ground
36	GND	—	Ground
37	GND	—	Ground
38	TMPWR	↔	Termination Power
39	GND	—	Ground
40	GND	—	Ground
41	/ATN	←	Attention
42	n/c	-	Not connected
43	/BSY	↔	Busy
44	/ACK	←	Acknowledge
45	/RST	↔	Reset
46	/MSG	→	Message
47	/SEL	↔	Select
48	/C/D	→	Control/Data
49	/REQ	→	Request
50	/I/O	→	Input/Output

Note: Direction is Device relative Bus (other Devices).

Contributor: Joakim Ögren <qtech@mailhost.net>

Source: ?

Please send any comments to Joakim Ögren <qtech@mailhost.net>.

SCSI External Centronics 50 (Differential)

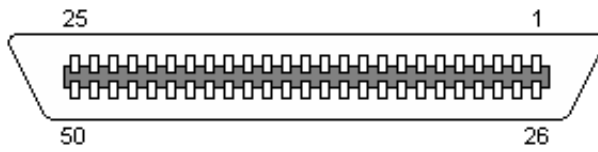

(At the controller & devices)

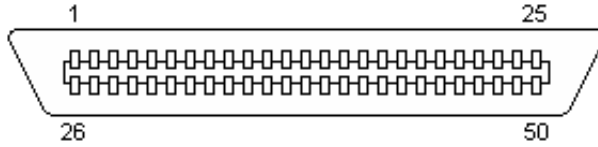









(At the cable)

50 PIN CENTRONICS FEMALE at the controller & devices.

50 PIN CENTRONICS MALE at the cable.

Pin Name	Dir	Description
01	GND	Ground
02	+DB0	+Data Bus 0
03	+DB1	+Data Bus 1
04	+DB2	+Data Bus 2
05	+DB3	+Data Bus 3
06	+DB4	+Data Bus 4
07	+DB5	+Data Bus 5
08	+DB6	+Data Bus 6
09	+DB7	+Data Bus 7
10	+DBP	+Data Bus Parity (odd Parity)
11	DIFFSENS ?	???
12	res	Reserved
13	TERMPWR	Termination Power
14	res	Reserved
15	+ATN	+Attention
16	GND	Ground
17	+BSY	+Bus is busy
18	+ACK	+Acknowledge
19	+RST	+Reset
20	+MSG	+Message
21	+SEL	+Select
22	+C/D	+Control or Data
23	+REQ	+Request
24	+I/O	+In/Out
25	GND	Ground
26	GND	Ground
27	-DB0	-Data Bus 0
28	-DB1	-Data Bus 1
29	-DB2	-Data Bus 2
30	-DB3	-Data Bus 3
31	-DB4	-Data Bus 4
32	-DB5	-Data Bus 5
33	-DB6	-Data Bus 6
34	-DB7	-Data Bus Parity7
35	-DBP	-Data Bus Parity (odd Parity)
36	GND	Ground
37	res	Reserved
38	TERMPWR	Termination Power
39	res	Reserved
40	-ATN	-Attention
41	GND	Ground
42	-BSY	-Bus is busy

43	-ACK		-Acknowledge
44	-RST		-Reset
45	-MSG		-Message
46	-SEL		-Select
47	-C/D		-Control or Data
48	-REQ		-Request
49	-I/O		-In/Out
50	GND		Ground

Note: Direction is Device relative Bus (other Devices).

Contributor: Joakim Ögren <qttech@mailhost.net>, Karsten Wenke <Karsten.Wenke@t-online.de>

Source: ?

Please send any comments to Joakim Ögren <qttech@mailhost.net>.

SCSI-II External Hi D-Sub (Single-ended)

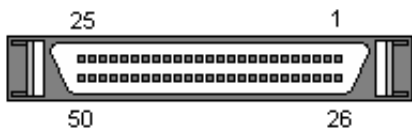

(At the controller & devices).

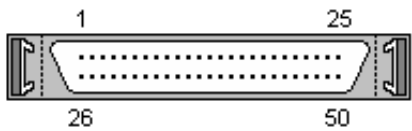

(To the cable).

50 PIN HI-DENSITY D-SUB FEMALE at the controller & devices.

50 PIN HI-DENSITY D-SUB MALE at the cable.

Pin	Name	Dir	Description
1-25	GND	—	Ground
26	DB0	↔	Data Bus 0
27	DB1	↔	Data Bus 1
28	DB2	↔	Data Bus 2
29	DB3	↔	Data Bus 3
30	DB4	↔	Data Bus 4
31	DB5	↔	Data Bus 5
32	DB6	↔	Data Bus 6
33	DB7	↔	Data Bus 7
34	PARITY	↔	Data Parity (odd Parity)
35	GND	—	Ground
36	GND	—	Ground
37	GND	—	Ground
38	TMPWR	↔	Termination Power
39	GND	—	Ground
40	GND	—	Ground
41	/ATN	←	Attention
42	n/c	-	Not connected
43	/BSY	↔	Busy
44	/ACK	←	Acknowledge
45	/RST	↔	Reset
46	/MSG	→	Message
47	/SEL	↔	Select
48	/C/D	→	Control/Data
49	/REQ	→	Request
50	/I/O	→	Input/Output

Note: Direction is Device relative Bus (other Devices).

Contributor: Joakim Ögren <qtech@mailhost.net>

Source: ?

Please send any comments to Joakim Ögren <qtech@mailhost.net>.

SCSI-II External Hi D-Sub (Differential)

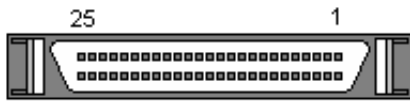

(At the controller & devices).

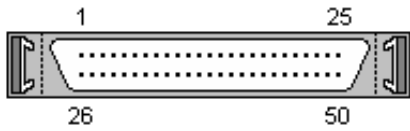

(To the cable).

50 PIN HI-DENSITY D-SUB FEMALE at the controller & devices.

50 PIN HI-DENSITY D-SUB MALE at the cable.

Pin Name	Dir	Description
01	GND	Ground
02	+DB0	+Data Bus 0
03	+DB1	+Data Bus 1
04	+DB2	+Data Bus 2
05	+DB3	+Data Bus 3
06	+DB4	+Data Bus 4
07	+DB5	+Data Bus 5
08	+DB6	+Data Bus 6
09	+DB7	+Data Bus 7
10	+DBP	+Data Bus Parity (odd Parity)
11	DIFFSENS	???
12	res	Reserved
13	TERMPWR	Termination Power
14	res	Reserved
15	+ATN	+Attention
16	GND	Ground
17	+BSY	+Bus is busy
18	+ACK	+Acknowledge
19	+RST	+Reset
20	+MSG	+Message
21	+SEL	+Select
22	+C/D	+Control or Data
23	+REQ	+Request
24	+I/O	+In/Out
25	GND	Ground
26	GND	Ground
27	-DB0	-Data Bus 0
28	-DB1	-Data Bus 1
29	-DB2	-Data Bus 2
30	-DB3	-Data Bus 3
31	-DB4	-Data Bus 4
32	-DB5	-Data Bus 5
33	-DB6	-Data Bus 6
34	-DB7	-Data Bus Parity7
35	-DBP	-Data Bus Parity (odd Parity)
36	GND	Ground
37	res	Reserved
38	TERMPWR	Termination Power
39	res	Reserved
40	-ATN	-Attention
41	GND	Ground
42	-BSY	-Bus is busy
43	-ACK	-Acknowledge

44	-RST		-Reset
45	-MSG		-Message
46	-SEL		-Select
47	-C/D		-Control or Data
48	-REQ		-Request
49	-I/O		-In/Out
50	GND		Ground

Note: Direction is Device relative Bus (other Devices).

Contributor: Joakim Ögren <qttech@mailhost.net>, Karsten Wenke <Karsten.Wenke@t-online.de>

Source: ?

Please send any comments to Joakim Ögren <qttech@mailhost.net>.

SCSI External D-Sub (Future Domain)

Seems to be available on some Future Domain SCSI-controllers only.

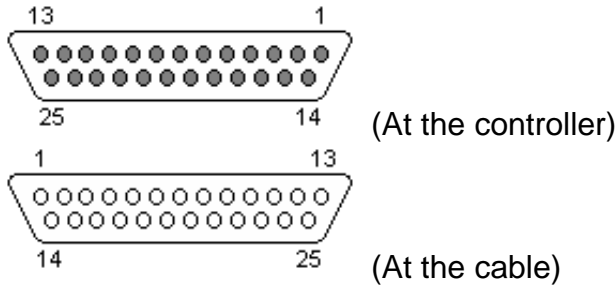

25 PIN D-SUB FEMALE at the controller.

25 PIN D-SUB MALE at the cable.

Pin	Pin Name	Dir	Description
1	GND	—	Ground
2	DB1	↔	Data Bus 1
3	DB3	↔	Data Bus 3
4	DB5	↔	Data Bus 5
5	DB7	↔	Data Bus 7
6	GND	—	Ground
7	/SEL	↔	Select
8	GND	—	Ground
9	TMPWR	↔	Termination Power
10	/RST	↔	Reset
11	C/D	→	Control/Data
12	I/O	→	Input/Output
13	GND	—	Ground
14	DB0	↔	Data Bus 0
15	DB2	↔	Data Bus 2
16	DB4	↔	Data Bus 4
17	DB6	↔	Data Bus 6
18	PARITY	↔	Data Parity
19	GND	—	Ground
20	/ATN	↑	Attention
21	/MSG	→	Message
22	/ACK	↑	Acknowledge
23	BSY	↔	Busy
24	/REQ	→	Request
25	GND	—	Ground

Note: Direction is Device relative Bus (other Devices).

Contributor: Joakim Ögren <qtech@mailhost.net>

Source: TheRef TechTalk <<http://theref.c3d.rl.af.mil>>

Please send any comments to Joakim Ögren <qtech@mailhost.net>.

SCSI External D-Sub (PC/Amiga/Mac)

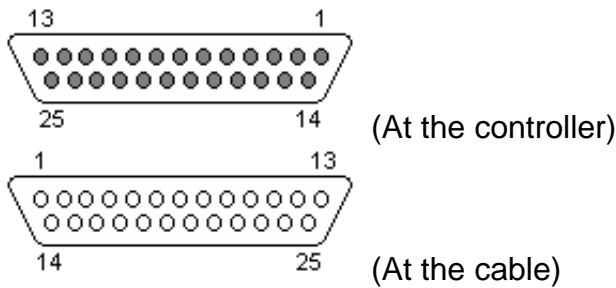

25 PIN D-SUB FEMALE at the controller.

25 PIN D-SUB MALE at the cable.

Pin Name	Dir	Description
1	/REQ	Request
2	/MSG	Message
3	I/O	Input/Output
4	/RST	Reset
5	/ACK	Acknowledge
6	BSY	Busy
7	GND	Ground
8	DB0	Data Bus 0
9	GND	Ground
10	DB3	Data Bus 3
11	DB5	Data Bus 5
12	DB6	Data Bus 6
13	DB7	Data Bus 7
14	GND	Ground
15	C/D	Control/Data
16	GND	Ground
17	/ATN	Attention
18	GND	Ground
19	/SEL	Select
20	PARITY	Data Parity
21	DB1	Data Bus 1
22	DB2	Data Bus 2
23	DB4	Data Bus 4
24	GND	Ground
25	TMPWR	Termination Power

Note: Direction is Device relative Bus (other Devices).

Contributor: Joakim Ögren <qtech@mailhost.net>

Source: ?

Please send any comments to Joakim Ögren <qtech@mailhost.net>.

Novell and Procomp External SCSI

This interface is nowadays considered obsolete.

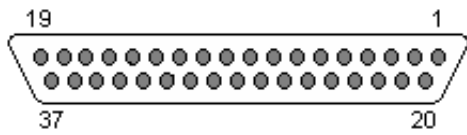

(At the controller)

37 PIN D-SUB FEMALE at the controller.

Pin	Pin Name	Dir	Description
1	GND	—	Ground
2	GND	—	Ground
3	GND	—	Ground
4	GND	—	Ground
5	GND	—	Ground
6	GND	—	Ground
7	GND	—	Ground
8	GND	—	Ground
9	GND	—	Ground
10	GND	—	Ground
11	GND	—	Ground
12	GND	—	Ground
13	GND	—	Ground
14	GND	—	Ground
15	GND	—	Ground
16	GND	—	Ground
17	GND	—	Ground
18	GND	—	Ground
19	TERMPWR	↕	Termination Power
20	/DB0	↕	Data Bus 0
21	/DB1	↕	Data Bus 1
22	/DB2	↕	Data Bus 2
23	/DB3	↕	Data Bus 3
24	/DB4	↕	Data Bus 4
25	/DB5	↕	Data Bus 5
26	/DB6	↕	Data Bus 6
27	/DB7	↕	Data Bus 7
28	/DBP	↕	Data Bus Parity
29	/ATN	↑	Attention
30	/BSY	↕	Busy
31	/ACK	↑	Acknowledge
32	/RST	↕	Reset
33	/MSG	↕	Message
34	/SEL	↕	Select
35	/C/D	↕	Control/Data
36	/REQ	↕	Request
37	/I/O	↕	Input/Output

Note: Direction is Device relative Bus (other Devices).

Contributor: Joakim Ögren <qtech@mailhost.net>, Randy Hoffman <runtime@borg.pulsenet.com>

Source: Black Box Corporation, FaxBack document for SCSI

Please send any comments to Joakim Ögren <qtech@mailhost.net>.

IDE Internal

IDE=Integrated Drive Electronics.

Developed by Compaq and Western Digital.

Newer version of IDE goes under the name ATA=AT bus Attachment.

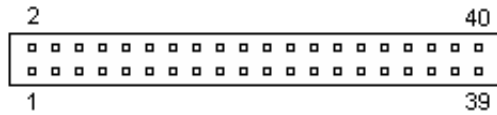

(At the controller & peripherals)

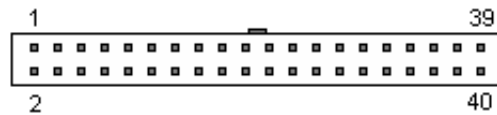

(At the cable)

40 PIN IDC MALE at the controller & peripherals.

40 PIN IDC FEMALE at the cable.

Pin Name	Dir	Description
1	/RESET	Reset
2	GND	Ground
3	DD7	Data 7
4	DD8	Data 8
5	DD6	Data 6
6	DD9	Data 9
7	DD5	Data 5
8	DD10	Data 10
9	DD4	Data 4
10	DD11	Data 11
11	DD3	Data 3
12	DD12	Data 12
13	DD2	Data 2
14	DD13	Data 13
15	DD1	Data 1
16	DD14	Data 14
17	DD0	Data 0
18	DD15	Data 15
19	GND	Ground
20	KEY	Key
21	n/c	Not connected
22	GND	Ground
23	/IOW	Write Strobe
24	GND	Ground
25	/IOR	Read Strobe
26	GND	Ground
27	IO_CH_RDY	
28	ALE	Address Latch Enable
29	n/c	Not connected
30	GND	Ground
31	IRQ	Interrupt Request
32	/IOCS16	IO ChipSelect 16
33	DA1	Address 1
34	n/c	Not connected
35	DA0	Address 0
36	DA2	Address 2
37	/IDE_CS0	(1F0-1F7)
38	/IDE_CS1	(3F6-3F7)
39	/ACTIVE	Led driver
40	GND	Ground

BETA RELEASE

Note: Direction is Controller relative Devices (Harddisks).

Contributors: Joakim Ögren , Dan Williams <dan_williams@sunshine.net>

Source: ?

Please send any comments to Joakim Ögren <qtech@mailhost.net>.

The Hardware Book is freely distributable but is copyrighted to Joakim Ögren. It may not be modified and re-distributed without the authors permission.

PRELIMINARY BETA. NOT FOR REDISTRIBUTION.

BETA RELEASE

ATA Internal

ATA=AT bus Attachment..

Developed by Western Digital, Conner & Seagate ?.

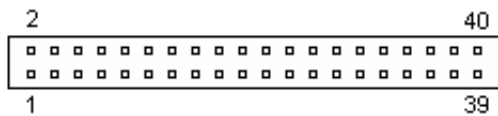

(At the controller & peripherals)

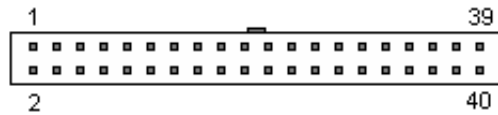

(At the cable)

40 PIN IDC MALE at the controller & peripherals.

40 PIN IDC FEMALE at the cable.

Pin Name	Dir	Description
1	→	/RESET Reset
2	—	GND Ground
3	↔	DD7 Data 7
4	↔	DD8 Data 8
5	↔	DD6 Data 6
6	↔	DD9 Data 9
7	↔	DD5 Data 5
8	↔	DD10 Data 10
9	↔	DD4 Data 4
10	↔	DD11 Data 11
11	↔	DD3 Data 3
12	↔	DD12 Data 12
13	↔	DD2 Data 2
14	↔	DD13 Data 13
15	↔	DD1 Data 1
16	↔	DD14 Data 14
17	↔	DD0 Data 0
18	↔	DD15 Data 15
19	—	GND Ground
20	-	KEY Key (Pin missing)
21	?	DMARQ DMA Request
22	—	GND Ground
23	→	/DIOW Write Strobe
24	—	GND Ground
25	→	/DIOR Read Strobe
26	—	GND Ground
27	←	IORDY I/O Ready
28	?	SPSYNC:CSEL Spindle Sync or Cable Select
29	?	/DMACK DMA Acknowledge
30	—	GND Ground
31	←	INTRQ Interrupt Request
32	?	/IOCS16 IO ChipSelect 16
33	→	DA1 Address 1
34	?	PDIAG Passed Diagnostics
35	→	DA0 Address 0
36	→	DA2 Address 2
37	→	/IDE_CS0 (1F0-1F7)
38	→	/IDE_CS1 (3F6-3F7)
39	→	/ACTIVE Led driver
40	—	GND Ground

Note: Direction is Controller relative Devices (Harddisks).

BETA RELEASE

Contributor: Joakim Ögren <qtech@mailhost.net>

Source: ?

Please send any comments to Joakim Ögren <qtech@mailhost.net>.

The Hardware Book is freely distributable but is copyrighted to Joakim Ögren. It may not be modified and re-distributed without the authors permission.

PRELIMINARY BETA. NOT FOR REDISTRIBUTION.

BETA RELEASE

ATA (44) Internal

ATA=AT bus Attachment.

This connector is mostly used for 2.5" internal harddisks.
See ATA for pin 1-40.

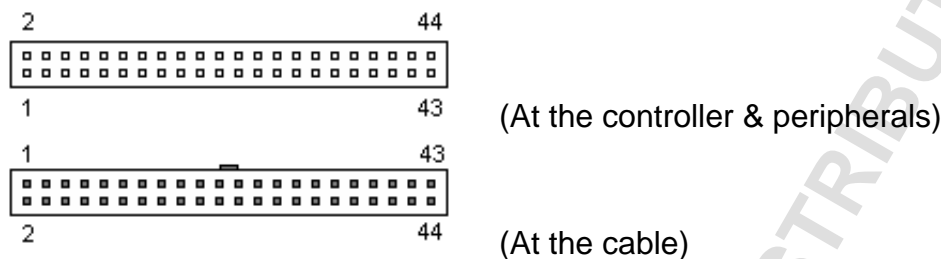

44 PIN IDC (0.75") MALE at the controller & peripherals.

44 PIN IDC (0.75") FEMALE at the cable.

Pin Name	Dir	Description
41	+5VL →	+5 VDC (Logic)
42	+5VM →	+5 VDC (Motor)
43	GND	Ground
44	/TYPE →	Type (0=ATA)

Note: Direction is Controller relative Devices (harddisks).

Contributor: Joakim Ögren <qtech@mailhost.net>

Source: ?

Please send any comments to Joakim Ögren <qtech@mailhost.net>.

ESDI

ESDI=Enhanced Small Device Interface.

Developed by Maxtor in the early 1980's as an upgrade and improvement to the ST506 design.

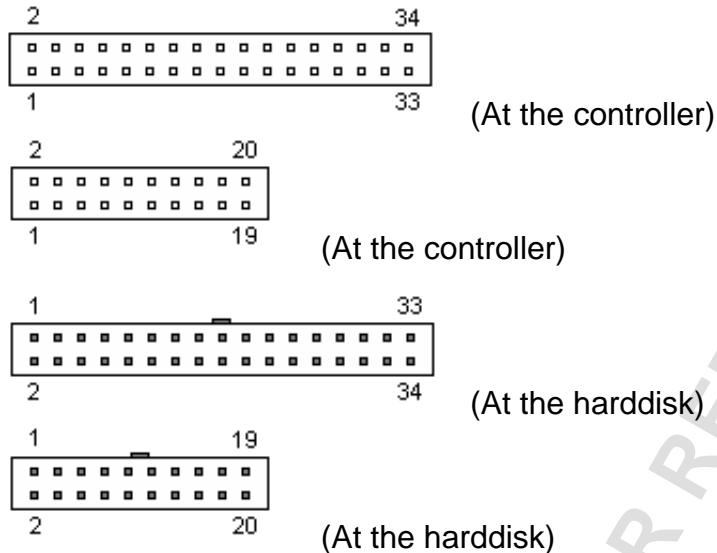

34 PIN IDC MALE at the Controller.
20 PIN IDC MALE at the Controller.

34 PIN IDC FEMALE at the Harddisk.
20 PIN IDC FEMALE at the Harddisk.

Control connector

Pin Name	Description
2	Head Sel 3
4	Head Sel 2
6	Write Gate
8	Config/Stat Data
10	Transfer Acknowledge
12	Attention
14	Head Sel 0
16	Sect/Add MK Found
18	Head Sel 1
20	Index
22	Ready
24	Transfer Request
26	Drive Sel 1
28	Drive Sel 2
30	Drive Sel 3
32	Read Gate
34	Command Data

Note: All odd are GND, Ground.

Data connector

Pin Name	Description
1	Drive Selected
2	Sect/Add MK Found
3	Seek Complete
4	Address Mark Enable

BETA RELEASE

5		(reserved, for step mode)
6	GND	Ground
7		Write Clock+
8		Write Clock-
9		Cartridge Changed
10		Read Ref Clock+
11		Read Ref Clock-
12	GND	Ground
13		NRZ Write Data+
14		NRZ Write Data-
15	GND	Ground
16	GND	Ground
17		NRZ Read Data+
18		NRZ Read Data-
19	GND	Ground
20	GND	Ground

Contributor: Joakim Ögren <qtech@mailhost.net>

Source: ?

Please send any comments to Joakim Ögren <qtech@mailhost.net>.

PRELIMINARY BETA. NOT FOR REDISTRIBUTION.

ST506/412

Developed by Seagate.

Also known as MFM or RLL since these are the encoding methods used to store data. Seagate originally developed it to support their ST506 (5 MB) and ST412 (10 MB) drives. The first drives used an encoding method called MFM (Modified Frequency Modulation). Later a new encoding method was developed, RLL (Run Length Limited). RLL had the advantage that it was possible to store 50% more with it. But it required better drives. This is almost never an problem. Often called 2,7 RLL because the recording scheme involves patterns with no more than 7 successive zeros and no less than two.

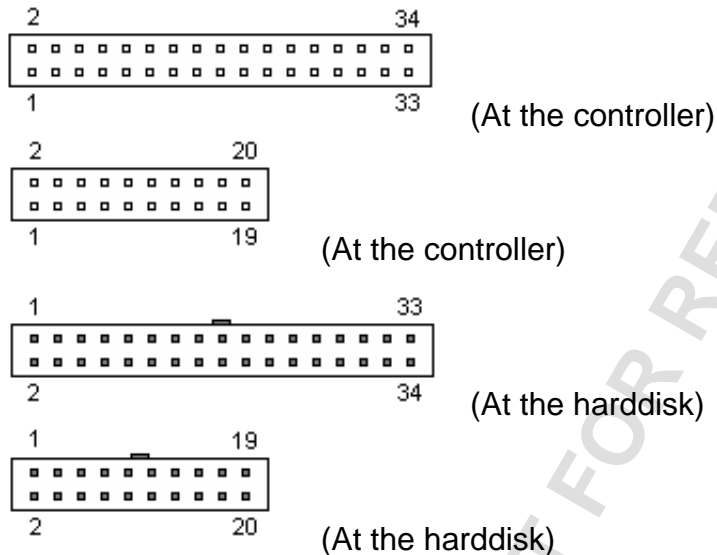

34 PIN IDC MALE at the Controller.
20 PIN IDC MALE at the Controller.

34 PIN IDC FEMALE at the Harddisk.
20 PIN IDC FEMALE at the Harddisk.

Control connector

Pin Name	Description
2	Head Sel 8
4	Head Sel 4
6	Write Gate
8	Seek Complete
10	Track 0
12	Write Fault
14	Head Sel 1
16	RES (reserved)
18	Head Sel 2
20	Index
22	Ready
24	Step
26	Drive Sel 1
28	Drive Sel 2
30	Drive Sel 3
32	Drive Sel 4
34	Direction In

Note: All odd pins are GND, Ground.

Data connector

BETA RELEASE

Pin Name	Description
1	Drive Selected
2 GND	Ground
3 RES	(reserved)
4 GND	Ground
5 RES	(reserved)
6 GND	Ground
7 RES	(reserved)
8 GND	Ground
9 RES	(reserved)
10 RES	(reserved)
11 GND	Ground
12 GND	Ground
13	Write Data+
14	Write Data-
15 GND	Ground
16 GND	Ground
17	Read Data+
18	Read Data-
19 GND	Ground
20 GND	Ground

Contributor: Joakim Ögren <qtech@mailhost.net>

Source: ?

Please send any comments to Joakim Ögren <qtech@mailhost.net>.

Paravision SX-1 External IDE

Paravision was formerly Microbotics.

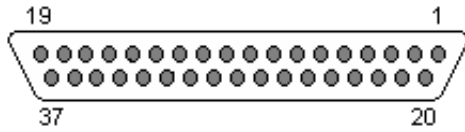

(At the controller)

37 PIN D-SUB FEMALE at the controller.

Pin Name	Description
1	/IDE-RESET Drive Reset
2	D0 Data bit 0
3	D2 Data bit 2
4	D4 Data bit 4
5	D6 Data bit 6
6	GND Ground
7	D8 Data bit 8
8	D10 Data bit 10
9	D12 Data bit 12
10	D14 Data bit 14
11	GND Ground
12	GND Ground
13	GND Ground
14	GND Ground
15	GND Ground
16	GND Ground
17	GND Ground
18	+5V 5V Power
19	+5V 5V Power
20	GND Ground
21	D1 Data bit 1
22	D3 Data bit 3
23	D5 Data bit 5
24	D7 Data bit 7
25	GND Ground
26	D9 Data bit 9
27	D11 Data bit 11
28	D13 Data bit 13
29	D15 Data bit 15
30	/IOW I/O Write
31	/IOR I/O Read
32	IDE-IRQ Interrupt Request
33	IDE-A2 Address bit 2
34	IDE-A1 Address bit 1
35	IDE-A0 Address bit 0
36	/BICS1 Chip Select 1
37	/BICS0 Chip Select 0

Contributor: Joakim Ögren <qtech@mailhost.net>

Source: SX-1 External IDE connector <ftp://ftp.demon.co.uk/pub/amiga/docs/cd32-pinouts.txt>, usenet posting by Mike Pinso <microbotics1@bix.com> at Paravision.

Please send any comments to Joakim Ögren <qtech@mailhost.net>.

Mitsumi CD-ROM

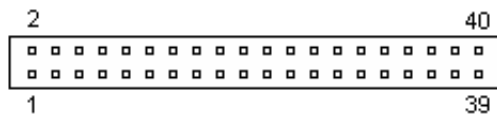

(at the controller & CD-ROM)

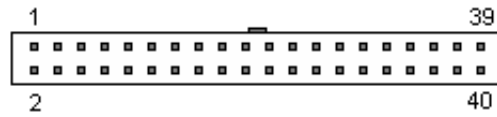

(at the cable.)

40 PIN IDC MALE at the controller & CD-ROM.

40 PIN IDC FEMALE at the cable.

Pin Name Description

Pin	Name	Description
1	A0	Address Bit 0
2	GND	Ground
3	A1	Address Bit 1
4	GND	Ground
5	n/c	Not connected
6	GND	Ground
7	n/c	Not connected
8	GND	Ground
9	n/c	Not connected
10	GND	Ground
11	n/c	Not connected
12	GND	Ground
13	INT	Interrupt
14	GND	Ground
15	REQ	Data request For DMA
16	GND	Ground
17	ACK	Data Acknowledge For DMA
18	GND	Ground
19	RE	Read Enable
20	GND	Ground
21	WE	Write Enable
22	GND	Ground
23	EN	Bus Enable
24	GND	Ground
25	DB0	Data Bit 0
26	GND	Ground
27	DB1	Data Bit 1
28	GND	Ground
29	DB2	Data Bit 2
30	GND	Ground
31	DB3	Data Bit 3
32	GND	Ground
33	DB4	Data Bit 4
34	GND	Ground
35	DB5	Data Bit 5
36	GND	Ground
37	DB6	Data Bit 6
38	GND	Ground
39	DB7	Data Bit 7
40	GND	Ground

Contributor: Keith Solomon <zarathos@thorn.bluedream.com>

Source: SoundFX 16-bit Multimedia Kit Hardware Manual from Reveal

Please send any comments to Joakim Ögren <qtech@mailhost.net>.

BETA RELEASE

The Hardware Book is freely distributable but is copyrighted to Joakim Ögren. It may not be modified and re-distributed without the authors permission.

PRELIMINARY BETA. NOT FOR REDISTRIBUTION.

BETA RELEASE

Panasonic CD-ROM

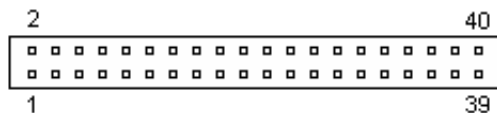

(at the controller & CD-ROM)

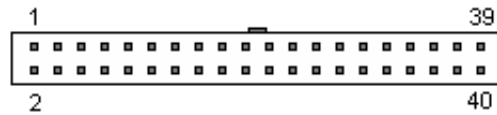

(at the cable.)

40 PIN IDC MALE at the controller & CD-ROM.

40 PIN IDC FEMALE at the cable.

Pin Name	Description
1	GND Ground
2	RESET CD-Reset
3	GND Ground
4	GND Ground
5	GND Ground
6	MODE0 Operation Mode Bit 0
7	GND Ground
8	MODE1 Operation Mode Bit 1
9	GND Ground
10	WRITE CD-Write
11	GND Ground
12	READ CD-Read
13	GND Ground
14	ST0 CD-Status Bit 0
15	GND Ground
16	n/c No Connection
17	GND Ground
18	n/c No Connection
19	GND Ground
20	ST1 CD-Status Bit 1
21	GND Ground
22	EN CD-Data Enable
23	GND Ground
24	ST2 CD-Status Bit 2
25	GND Ground
26	S/DE CD-Status/Data Enable
27	GND Ground
28	ST3 CD-Status Bit 3
29	GND ground
30	GND ground
31	D7 CD-Data 7
32	D6 CD-Data 6
33	GND ground
34	D5 CD-Data 5
35	D4 CD-Data 4
36	D3 CD-Data 3
37	GND ground
38	D2 CD-Data 2
39	D1 CD-Data 1
40	D0 CD-Data 0

Contributor: Keith Solomon <zarathos@thorn.bluedream.com>

Source: SoundFX 16-bit Multimedia Kit Hardware Manual from Reveal

Please send any comments to Joakim Ögren <qtech@mailhost.net>.

BETA RELEASE

The Hardware Book is freely distributable but is copyrighted to Joakim Ögren. It may not be modified and re-distributed without the authors permission.

PRELIMINARY BETA. NOT FOR REDISTRIBUTION.

BETA RELEASE

Sony CD-ROM

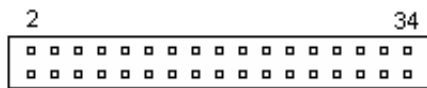

(at the controller & CD-ROM)

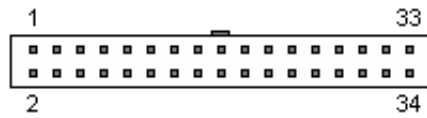

(at the cable.)

34 PIN IDC MALE at the controller & CD-ROM.

34 PIN IDC FEMALE at the cable.

Pin Name	Description
1	RESET Reset
2	GND Ground
3	DB7 Data Bit 7
4	GND Ground
5	DB6 Data Bit 6
6	GND Ground
7	DB5 Data Bit 5
8	GND Ground
9	DB4 Data Bit 4
10	GND Ground
11	DB3 Data Bit 3
12	GND Ground
13	DB2 Data Bit 2
14	GND Ground
15	DB1 Data Bit 1
16	GND Ground
17	DB0 Data Bit 0
18	GND Ground
19	WE Write Enable
20	GND Ground
21	RE Read Enable
22	GND Ground
23	ACK Data Acknowledge For DMA
24	GND Ground
25	REQ Data Request For DMA
26	GND Ground
27	INT Interrupt
28	GND Ground
29	A1 Address Bit 1
30	GND Ground
31	A0 Address Bit 0
32	GND Ground
33	EN Bus Enable
34	GND Ground

Contributor: Keith Solomon <zarathos@thorn.bluedream.com>

Source: SoundFX 16-bit Multimedia Kit Hardware Manual from Reveal

Please send any comments to Joakim Ögren <qtech@mailhost.net>.

C64 Cassette

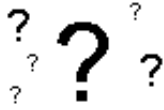

(At the computer)

6 PIN MALE EDGE at the computer.

Pin Name	Dir	Description
A-1 GND	—	Ground
B-2 +5V	→	+5 Volts DC
C-3 MOTOR	→	Cassette Motor
D-4 READ	←	Cassette Read
E-5 WRITE	→	Cassette Write
F-6 SENSE	→	Cassette Sense

Note: Direction is Computer relative Cassette.

Contributor: Joakim Ögren <qtech@mailhost.net>, Arwin Vosselman <0vosselman01@flnet.nl>

Source: Commodore 64 Programmer's Reference Guide

Please send any comments to Joakim Ögren <qtech@mailhost.net>.

C16/C116/+4 Cassette

Available on the Commodore C16, C116 and +4 computers.



(At the computer)

7 PIN MINI-DIN FEMALE at the computer.

Pin Name	Dir	Description
1 GND	—	Ground
2 +5V	→	+5 Volts DC
3 MOTOR	→	Cassette Motor
4 READ	←	Cassette Read
5 WRITE	→	Cassette Write
6 SENSE	→	Cassette Sense
7 GND	—	Ground

Note: Direction is Computer relative Cassette.

Contributor: Joakim Ögren <qtech@mailhost.net>, Arwin Vosselman <0vosselman01@flnet.nl>

Source: SAMS Computerfacts CC8 Commodore 16.

Please send any comments to Joakim Ögren <qtech@mailhost.net>.

CoCo Cassette

Available on the Tandy/Radio Shack Color Computer (CoCo).

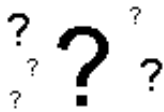

(At the CoCo)

UNKNOWN CONNECTOR at the CoCo.

Pin Description

- 1 Motor Relay
- 2 Ground
- 3 Motor Relay
- 4 Signal Input
- 5 Signal Output

Contributor: Joakim Ögren <qtech@mailhost.net>

Source: Tandy Color Computer FAQ <<http://www.io.com/~vga2000/faqs/coco.faq>> at Video Game Advantage's homepage <<http://www.io.com/~vga2000/>>

Please send any comments to Joakim Ögren <qtech@mailhost.net>.

MSX Cassette

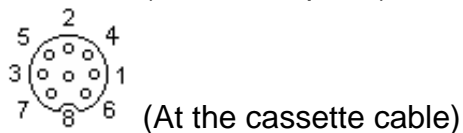
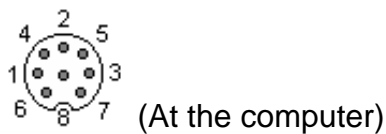

8 PIN DIN (DIN45326) FEMALE at the computer.

8 PIN DIN (DIN45326) MALE at the cassette cable.

Pin	Name	Dir	Description
1	GND	—	Ground
2	GND	—	Ground
3	GND	—	Ground
4	CMTOUT	→	Sound Output
5	CMTIN	←	Sound Input
6	REM+	→	Remote control (from relay)
7	REM-	→	Remote control (from relay)
8	GND	—	Ground

Note: Direction is Computer relative Cassette.

Contributor: Joakim Ögren <qtech@mailhost.net>

Source: Mayer's SV738 X'press I/O map <<http://www.freeflight.com/fms/MSX/Portar.txt>>

Please send any comments to Joakim Ögren <qtech@mailhost.net>.

Spectravideo SVI318/328 Cassette

```

+-----+
| 1 2 3 4 5 6 7 |
+-----+

```

```

? ? ?
? ? ?
? ? ?

```

(At the computer)

7 PIN FEMALE EDGE CONNECTOR at the computer.

Pin Name	Description
1 12v	Power 100mA
2 CASR	Cassette data read
3 CASW	Cassette data write
4 AUDIO	Cassette audio
5 GND	System ground
6 ME	
7 READY	System Ready

Contributer: Rob Gill <gillz@mpx.com.au>

Source: SVI mk II user manual

Please send any comments to Joakim Ögren <qtech@mailhost.net>.

PRELIMINARY BETA. NOT FOR REDISTRIBUTION.

Amstrad CPC6128 Tape

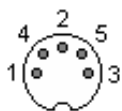

(At the computer)

5 PIN DIN 180° (DIN41524) FEMALE at the computer.

Pin Name

- 1 REMOTE SWITCH
- 2 GND
- 3 REMOTE SWITCH
- 4 DATA IN
- 5 DATA OUT

Contributor: Joakim Ögren <qtech@mailhost.net>, Agnello Guarracino <aggy@ooh.diron.co.uk>

Source: Amstrad CPC6128 User Instructions Manual

Please send any comments to Joakim Ögren <qtech@mailhost.net>.

PRELIMINARY BETA. NOT FOR REDISTRIBUTION.

30 pin SIMM

SIMM=Single Inline Memory Module.

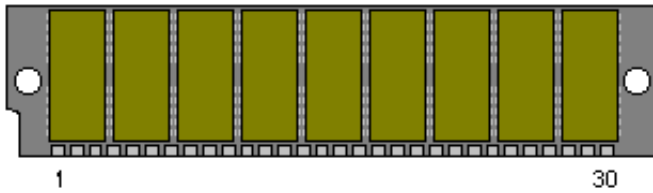

(At the computer)

30 PIN SIMM at the computer.

Pin Name	Description
1	VCC +5 VDC
2	/CAS Column Address Strobe
3	DQ0 Data 0
4	A0 Address 0
5	A1 Address 1
6	DQ1 Data 1
7	A2 Address 2
8	A3 Address 3
9	GND Ground
10	DQ2 Data 2
11	A4 Address 4
12	A5 Address 5
13	DQ3 Data 3
14	A6 Address 6
15	A7 Address 7
16	DQ4 Data 4
17	A8 Address 8
18	A9 Address 9
19	A10 Address 10
20	DQ5 Data 5
21	/WE Write Enable
22	GND Ground
23	DQ6 Data 6
24	n/c Not connected
25	DQ7 Data 7
26	QP Data Parity Out
27	/RAS Row Address Strobe
28	/CASP Something Parity ????
29	DP Data Parity In
30	VCC +5 VDC

Note: SIMM above is a 4MBx9.

QP & DP is N/C on SIMMs without parity.

A9 is N/C on 256kB.

A10 is N/C on 256kB & 1MB.

Contributor: Joakim Ögren <qtech@mailhost.net>

Source: comp.sys.ibm.pc.hardware.* FAQ Part 4
<ftp://rtfm.mit.edu/pub/usenet/news.answers/pc-hardware-faq/part1>, maintained by Ralph Valentino
<ralf@alum.wpi.edu>

Please send any comments to Joakim Ögren <qtech@mailhost.net>.

72 pin SIMM

SIMM=Single Inline Memory Module

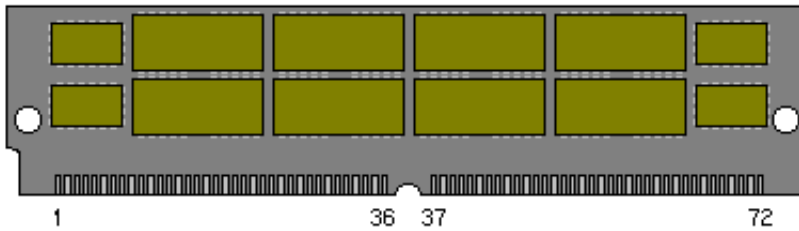

(At the computer)

72 PIN SIMM at the computer.

Pin	Non-Parity	Parity	Description
1	VSS	VSS	Ground
2	DQ0	DQ0	Data 0
3	DQ18	DQ18	Data 18
4	DQ1	DQ1	Data 1
5	DQ19	DQ19	Data 19
6	DQ2	DQ2	Data 2
7	DQ20	DQ20	Data 20
8	DQ3	DQ3	Data 3
9	DQ21	DQ21	Data 21
10	VCC	VCC	+5 VDC
11	n/c	n/c	Not connected
12	A0	A0	Address 0
13	A1	A1	Address 1
14	A2	A2	Address 2
15	A3	A3	Address 3
16	A4	A4	Address 4
17	A5	A5	Address 5
18	A6	A6	Address 6
19	A10	A10	Address 10
20	DQ4	DQ4	Data 4
21	DQ22	DQ22	Data 22
22	DQ5	DQ5	Data 5
23	DQ23	DQ23	Data 23
24	DQ6	DQ6	Data 6
25	DQ24	DQ24	Data 24
26	DQ7	DQ7	Data 7
27	DQ25	DQ25	Data 25
28	A7	A7	Address 7
29	A11	A11	Address 11
30	VCC	VCC	+5 VDC
31	A8	A8	Address 8
32	A9	A9	Address 9
33	/RAS3	/RAS3	Row Address Strobe 3
34	/RAS2	/RAS2	Row Address Strobe 2
35	n/c	PQ26	Parity 26 (3rd)
36	n/c	PQ8	Parity 8 (1st)
37	n/c	PQ17	Parity 26 (3rd)
38	n/c	PQ35	Parity 35 (4th)
39	VSS	VSS	Ground
40	/CAS0	/CAS0	Column Address Strobe 0
41	/CAS2	/CAS2	Column Address Strobe 2
42	/CAS3	/CAS3	Column Address Strobe 3
43	/CAS1	/CAS1	Column Address Strobe 1
44	/RAS0	/RAS0	Row Address Strobe 0

BETA RELEASE

45	/RAS1	/RAS1	Row Address Strobe 1
46	n/c	n/c	Not connected
47	/WE	/WE	Read/Write
48	n/c	n/c	Not connected
49	DQ9	DQ9	Data 9
50	DQ27	DQ27	Data 27
51	DQ10	DQ10	Data 10
52	DQ28	DQ28	Data 28
53	DQ11	DQ11	Data 11
54	DQ29	DQ29	Data 29
55	DQ12	DQ12	Data 12
56	DQ30	DQ30	Data 30
57	DQ13	DQ13	Data 13
58	DQ31	DQ31	Data 31
59	VCC	VCC	+5 VDC
60	DQ32	DQ32	Data 32
61	DQ14	DQ14	Data 14
62	DQ33	DQ33	Data 33
63	DQ15	DQ15	Data 15
64	DQ34	DQ34	Data 34
65	DQ16	DQ16	Data 16
66	n/c	n/c	Not connected
67	PD1	PD1	Presence Detect 1
68	PD2	PD2	Presence Detect 2
69	PD3	PD3	Presence Detect 3
70	PD4	PD4	Presence Detect 4
71	n/c	n/c	Not connected
72	VSS	VSS	Ground

Size:

PD2	PD1	Size
GND	GND	4 or 64 MB
GND	NC	2 or 32 MB
NC	GND	1 or 16 MB
NC	NC	8 MB

Accesstime:

PD4	PD3	Accesstime
GND	GND	50, 100 ns
GND	NC	80 ns
NC	GND	70 ns
NC	NC	60 ns

Notes: A9 is a N/C on 256k and 512k modules.

A10 is a N/C on 256k, 512k, 1M and 4M modules.

RAS1/RAS3 are N/C on 256k, 1M and 4M modules.

Contributor: Joakim Ögren <qtech@mailhost.net>, Mark Brown <bugman@total.net>, Karsten Wenke <Karsten.Wenke@t-online.de>

Source: Various productsheets at IBM Memory Products <<http://www.chips.ibm.com/products/memory/>>

Please send any comments to Joakim Ögren <qtech@mailhost.net>.

72 pin ECC SIMM

SIMM=Single Inline Memory Module
ECC=Error Correcting Code.

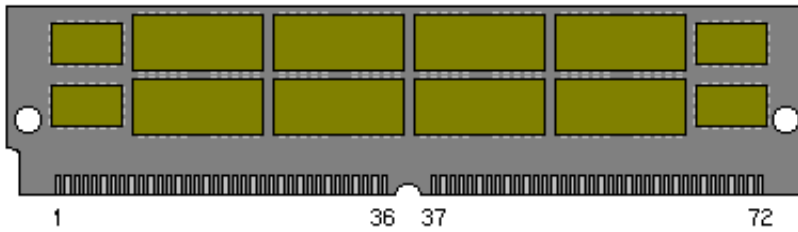

(At the computer)

72 PIN SIMM at the computer.

Pin	ECC	Optimized	Description
1	VSS	VSS	Ground
2	DQ0	DQ0	Data 0
3	DQ1	DQ1	Data 1
4	DQ2	DQ2	Data 2
5	DQ3	DQ3	Data 3
6	DQ4	DQ4	Data 4
7	DQ5	DQ5	Data 5
8	DQ6	DQ6	Data 6
9	DQ7	DQ7	Data 7
10	VCC	VCC	+5 VDC
11	PD5	PD5	Presence Detect 5
12	A0	A0	Address 0
13	A1	A1	Address 1
14	A2	A2	Address 2
15	A3	A3	Address 3
16	A4	A4	Address 4
17	A5	A5	Address 5
18	A6	A6	Address 6
19	n/c	n/c	Not connected
20	DQ8	DQ8	Data 8
21	DQ9	DQ9	Data 9
22	DQ10	DQ10	Data 10
23	DQ11	DQ11	Data 11
24	DQ12	DQ12	Data 12
25	DQ13	DQ13	Data 13
26	DQ14	DQ14	Data 14
27	DQ15	DQ15	Data 15
28	A7	A7	Address 7
29	DQ16	DQ16	Data 16
30	VCC	VCC	+5 VDC
31	A8	A8	Address 8
32	A9	A9	Address 9
33	n/c	n/c	Not connected
34	/RAS1	/RAS1	Row Address Strobe 1
35	DQ17	DQ17	Data 17
36	DQ18	DQ18	Data 18
37	DQ19	DQ19	Data 19
38	DQ20	DQ20	Data 20
39	VSS	VSS	Ground
40	/CAS0	/CAS0	Column Address Strobe 0
41	A10	A10	Address 10
42	A11	A11	Address 11
43	/CAS1	/CAS1	Column Address Strobe 1

BETA RELEASE

44	/RAS0	/RAS0	Row Address Strobe 0
45	/RAS1	/RAS1	Row Address Strobe 1
46	DQ21	DQ21	Data 21
47	/WE	/WE	Read/Write
48	/ECC	/ECC	
49	DQ22	DQ22	Data 22
50	DQ23	DQ23	Data 23
51	DQ24	DQ24	Data 24
52	DQ25	DQ25	Data 25
53	DQ26	DQ26	Data 26
54	DQ27	DQ27	Data 27
55	DQ28	DQ28	Data 28
56	DQ29	DQ29	Data 29
57	DQ30	DQ30	Data 30
58	DQ31	DQ31	Data 31
59	VCC	VCC	+5 VDC
60	DQ32	DQ32	Data 32
61	DQ33	DQ33	Data 33
62	DQ34	DQ34	Data 34
63	DQ35	DQ35	Data 35
64	n/c	DQ36	Data 36
65	n/c	DQ37	Data 37
66	n/c	DQ38	Data 38
67	PD1	PD1	Presence Detect 1
68	PD2	PD2	Presence Detect 2
69	PD3	PD3	Presence Detect 3
70	PD4	PD4	Presence Detect 4
71	n/c	DQ39	Data 39
72	VSS	VSS	Ground

Contributor: Joakim Ögren <qtech@mailhost.net>

Source: Various productsheets at IBM Memory Products <<http://www.chips.ibm.com/products/memory/>>

Please send any comments to Joakim Ögren <qtech@mailhost.net>.

72 pin SO DIMM

SO DIMM=Small Outline Dual Inline Memory Module

**NOT
DRAWN
YET...**



(At the computer)

72 PIN SO DIMM at the computer.

Pin	Non-Parity	Parity	Description
1	VSS	VSS	Ground
2	DQ0	DQ0	Data 0
3	DQ1	DQ1	Data 1
4	DQ2	DQ2	Data 2
5	DQ3	DQ3	Data 3
6	DQ4	DQ4	Data 4
7	DQ5	DQ5	Data 5
8	DQ6	DQ6	Data 6
9	DQ7	DQ7	Data 7
10	VCC	VCC	+5 VDC
11	PD1	PD1	Presence Detect 1
12	A0	A0	Address 0
13	A1	A1	Address 1
14	A2	A2	Address 2
15	A3	A3	Address 3
16	A4	A4	Address 4
17	A5	A5	Address 5
18	A6	A6	Address 6
19	A10	A10	Address 10
20	n/c	PQ8	Data 8 (Parity 1)
21	DQ9	DQ9	Data 9
22	DQ10	DQ10	Data 10
23	DQ11	DQ11	Data 11
24	DQ12	DQ12	Data 12
25	DQ13	DQ13	Data 13
26	DQ14	DQ14	Data 14
27	DQ15	DQ15	Data 15
28	A7	A7	Address 7
29	A11	A11	Address 11
30	VCC	VCC	+5 VDC
31	A8	A8	Address 8
32	A9	A9	Address 9
33	/RAS3	RAS3	Row Address Strobe 3
34	/RAS2	RAS2	Row Address Strobe 2
35	DQ16	DQ16	Data 16
36	n/c	PQ17	Data 17 (Parity 2)
37	DQ18	DQ18	Data 18
38	DQ19	DQ19	Data 19
39	VSS	VSS	Ground
40	/CAS0	CAS0	Column Address Strobe 0
41	/CAS2	CAS2	Column Address Strobe 2
42	/CAS3	CAS3	Column Address Strobe 3
43	/CAS1	CAS1	Column Address Strobe 1
44	/RAS0	RAS0	Row Address Strobe 0
45	/RAS1	RAS1	Row Address Strobe 1
46	A12	A12	Address 12
47	/WE	WE	Read/Write

BETA RELEASE

48	A13	A13	Address 13
49	DQ20	DQ20	Data 20
50	DQ21	DQ21	Data 21
51	DQ22	DQ22	Data 22
52	DQ23	DQ23	Data 23
53	DQ24	DQ24	Data 24
54	DQ25	DQ25	Data 25
55	n/c	PQ26	Data 26 (Parity 3)
56	DQ27	DQ27	Data 27
57	DQ28	DQ28	Data 28
58	DQ29	DQ29	Data 29
59	DQ31	DQ31	Data 31
60	DQ30	DQ30	Data 30
61	VCC	VCC	+5 VDC
62	DQ32	DQ32	Data 32
63	DQ33	DQ33	Data 33
64	DQ34	DQ34	Data 34
65	n/c	PQ35	Data 35 (Parity 4)
66	PD2	PD2	Presence Detect 2
67	PD3	PD3	Presence Detect 3
68	PD4	PD4	Presence Detect 4
69	PD5	PD5	Presence Detect 1
70	PD6	PD6	Presence Detect 6
71	PD7	PD7	Presence Detect 7
72	VSS	VSS	Ground

Contributor: Joakim Ögren <qtech@mailhost.net>, Mark Brown <bugman@total.net>, Jim Burd <JimBurd@aol.com>

Source: Various productsheets at IBM Memory Products <<http://www.chips.ibm.com/products/memory/>>

Please send any comments to Joakim Ögren <qtech@mailhost.net>.

144 pin SO DIMM

SO SIMM=Small Outline Single Inline Memory Module

**NOT
DRAWN
YET...**



(At the computer)

144 PIN SO SIMM at the computer.

Pin	Normal	ECC	Description
1	VSS	VSS	Ground
2	VSS	VSS	Ground
3	DQ0	DQ0	Data 0
4	DQ32	DQ32	Data 32
5	DQ1	DQ1	Data 1
6	DQ33	DQ33	Data 33
7	DQ2	DQ2	Data 2
8	DQ34	DQ34	Data 34
9	DQ3	DQ3	Data 3
10	DQ35	DQ35	Data 35
11	VCC	VCC	+5 VDC
12	VCC	VCC	+5 VDC
13	DQ4	DQ4	Data 4
14	DQ36	DQ36	Data 36
15	DQ5	DQ5	Data 5
16	DQ37	DQ37	Data 37
17	DQ6	DQ6	Data 6
18	DQ38	DQ38	Data 38
19	DQ7	DQ7	Data 7
20	DQ39	DQ39	Data 39
21	VSS	VSS	Ground
22	VSS	VSS	Ground
23	/CAS0	/CAS0	Column Address Strobe 0
24	/CAS4	/CAS4	Column Address Strobe 4
25	/CAS1	/CAS1	Column Address Strobe 1
26	/CAS5	/CAS5	Column Address Strobe 5
27	VCC	VCC	+5 VDC
28	VCC	VCC	+5 VDC
29	A0	A0	Address 0
30	A3	A3	Address 3
31	A1	A1	Address 1
32	A4	A4	Address 4
33	A2	A2	Address 2
34	A5	A5	Address 5
35	VSS	VSS	Ground
36	VSS	VSS	Ground
37	DQ8	DQ8	Data 8
38	DQ40	DQ40	Data 40
39	DQ9	DQ9	Data 9
40	DQ41	DQ41	Data 41
41	DQ10	DQ10	Data 10
42	DQ42	DQ42	Data 42
43	DQ11	DQ11	Data 11
44	DQ43	DQ43	Data 43
45	VCC	VCC	+5 VDC
46	VCC	VCC	+5 VDC
47	DQ12	DQ12	Data 12

BETA RELEASE

48	DQ44	DQ44	Data 44
49	DQ13	DQ13	Data 13
50	DQ45	DQ45	Data 45
51	DQ14	DQ14	Data 14
52	DQ46	DQ46	Data 46
53	DQ15	DQ15	Data 15
54	DQ47	DQ47	Data 47
55	VSS	VSS	Ground
56	VSS	VSS	Ground
57	n/c	CB0	
58	n/c	CB4	
59	n/c	CB1	
60	n/c	CB5	
61	DU	DU	Don't use
62	DU	DU	Don't use
63	VCC	VCC	+5 VDC
64	VCC	VCC	+5 VDC
65	DU	DU	Don't use
66	DU	DU	Don't use
67	/WE	/WE	Read/Write
68	n/c	n/c	Not connected
69	/RAS0	/RAS0	Row Address Strobe 0
70	n/c	n/c	Not connected
71	/RAS1	/RAS1	Row Address Strobe 1
72	n/c	n/c	Not connected
73	/OE	/OE	
74	n/c	n/c	Not connected
75	VSS	VSS	Ground
76	VSS	VSS	Ground
77	n/c	CB2	
78	n/c	CB6	
79	n/c	CB3	
80	n/c	CB7	
81	VCC	VCC	+5 VDC
82	VCC	VCC	+5 VDC
83	DQ16	DQ16	Data 16
84	DQ48	DQ48	Data 48
85	DQ17	DQ17	Data 17
86	DQ49	DQ49	Data 49
87	DQ18	DQ18	Data 18
88	DQ50	DQ50	Data 50
89	DQ19	DQ19	Data 19
90	DQ51	DQ51	Data 51
91	VSS	VSS	Ground
92	VSS	VSS	Ground
93	DQ20	DQ20	Data 20
94	DQ52	DQ52	Data 52
95	DQ21	DQ21	Data 21
96	DQ53	DQ53	Data 53
97	DQ22	DQ22	Data 22
98	DQ54	DQ54	Data 54
99	DQ23	DQ23	Data 23
100	DQ55	DQ55	Data 55
101	VCC	VCC	+5 VDC
102	VCC	VCC	+5 VDC
103	A6	A6	Address 6
104	A7	A7	Address 7
105	A8	A8	Address 8
106	A11	A11	Address 11
107	VSS	VSS	Ground

BETA RELEASE

108	VSS	VSS	Ground
109	A9	A9	Address 9
110	A12	A12	Address 12
111	A10	A10	Address 10
112	A13	A13	Address 13
113	VCC	VCC	+5 VDC
114	VCC	VCC	+5 VDC
115	/CAS2	/CAS2	Column Address Strobe 2
116	/CAS6	/CAS6	Column Address Strobe 6
117	/CAS3	/CAS3	Column Address Strobe 3
118	/CAS7	/CAS7	Column Address Strobe 7
119	VSS	VSS	Ground
120	/VSS	/VSS	Ground
121	DQ24	DQ24	Data 24
122	DQ56	DQ56	Data 56
123	DQ25	DQ25	Data 25
124	DQ57	DQ57	Data 57
125	DQ26	DQ26	Data 26
126	DQ58	DQ58	Data 58
127	DQ27	DQ27	Data 27
128	DQ59	DQ59	Data 59
129	VCC	VCC	+5 VDC
130	VCC	VCC	+5 VDC
131	DQ28	DQ28	Data 28
132	DQ60	DQ60	Data 60
133	DQ29	DQ29	Data 29
134	DQ61	DQ61	Data 61
135	DQ30	DQ30	Data 30
136	DQ62	DQ62	Data 62
137	DQ31	DQ31	Data 31
138	DQ63	DQ63	Data 63
139	VSS	VSS	Ground
140	VSS	VSS	Ground
141	SDA	SDA	
142	SCL	SCL	
143	VCC	VCC	+5 VDC
144	VCC	VCC	+5 VDC

Contributor: Joakim Ögren <qtech@mailhost.net>, Mark Brown <bugman@total.net>

Source: Various productsheets at IBM Memory Products <<http://www.chips.ibm.com/products/memory/>>

Please send any comments to Joakim Ögren <qtech@mailhost.net>.

168 pin DRAM DIMM (Unbuffered)

DIMM=Dual Inline Memory Module

**NOT
DRAWN
YET...**



(At the computer)

168 PIN DIMM at the computer.

Front Side (left side 1-42, right side 43-84)

Back Side (left side 85-126, right side 127-168)

Front, Left

Pin	Non-Parity?	Parity?	72 ECC?	80 ECC?	Description
1	VSS	VSS	VSS	VSS	Ground
2	DQ0	DQ0	DQ0	DQ0	Data 0
3	DQ1	DQ1	DQ1	DQ1	Data 1
4	DQ2	DQ2	DQ2	DQ2	Data 2
5	DQ3	DQ3	DQ3	DQ3	Data 3
6	VCC	VCC	VCC	VCC	+5 VDC or +3.3 VDC
7	DQ4	DQ4	DQ4	DQ4	Data 4
8	DQ5	DQ5	DQ5	DQ5	Data 5
9	DQ6	DQ6	DQ6	DQ6	Data 6
10	DQ7	DQ7	DQ7	DQ7	Data 7
11	DQ8	DQ8	DQ8	DQ8	Data 8
12	VSS	VSS	VSS	VSS	Ground
13	DQ9	DQ9	DQ9	DQ9	Data 9
14	DQ10	DQ10	DQ10	DQ10	Data 10
15	DQ11	DQ11	DQ11	DQ11	Data 11
16	DQ12	DQ12	DQ12	DQ12	Data 12
17	DQ13	DQ13	DQ13	DQ13	Data 13
18	VCC	VCC	VCC	VCC	+5 VDC or +3.3 VDC
19	DQ14	DQ14	DQ14	DQ14	Data 14
20	DQ15	DQ15	DQ15	DQ15	Data 15
21	n/c	CB0	CB0	CB0	Parity/Check Bit Input/Output 0
22	n/c	CB1	CB1	CB1	Parity/Check Bit Input/Output 1
23	VSS	VSS	VSS	VSS	Ground
24	n/c	n/c	n/c	CB8	Parity/Check Bit Input/Output 8
25	n/c	n/c	n/c	CB9	Parity/Check Bit Input/Output 9
26	VCC	VCC	VCC	VCC	+5 VDC or +3.3 VDC
27	/WE0	/WE0	/WE0	/WE0	Read/Write Input
28	/CAS0	/CAS0	/CAS0	/CAS0	Column Address Strobe 0
29	/CAS1	/CAS1	/CAS1	/CAS1	Column Address Strobe 1
30	/RAS0	/RAS0	/RAS0	/RAS0	Row Address Strobe 0
31	/OE0	/OE0	/OE0	/OE0	Output Enable
32	VSS	VSS	VSS	VSS	Ground
33	A0	A0	A0	A0	Address 0
34	A2	A2	A2	A2	Address 2
35	A4	A4	A4	A4	Address 4
36	A6	A6	A6	A6	Address 6
37	A8	A8	A8	A8	Address 8
38	A10	A10	A10	A10	Address 10
39	A12	A12	A12	A12	Address 12
40	VCC	VCC	VCC	VCC	+5 VDC or +3.3 VDC
41	VCC	VCC	VCC	VCC	+5 VDC or +3.3 VDC
42	DU	DU	DU	DU	Don't Use

BETA RELEASE

Front, Right

Pin	Non-Parity?	Parity?	72 ECC?	80 ECC?	Description
43	VSS	VSS	VSS	VSS	Ground
44	/OE2	/OE2	/OE2	/OE2	
45	/RAS2	/RAS2	/RAS2	/RAS2	Row Address Strobe 2
46	/CAS2	/CAS2	/CAS2	/CAS2	Column Address Strobe 2
47	/CAS3	/CAS3	/CAS3	/CAS3	Column Address Strobe 3
48	/WE2	/WE2	/WE2	/WE2	Read/Write Input
49	VCC	VCC	VCC	VCC	+5 VDC or +3.3 VDC
50	n/c	n/c	n/c	CB10	Parity/Check Bit Input/Output 10
51	n/c	n/c	n/c	CB11	Parity/Check Bit Input/Output 11
52	n/c	CB2	CB2	CB2	Parity/Check Bit Input/Output 2
53	n/c	CB3	CB3	CB3	Parity/Check Bit Input/Output 3
54	VSS	VSS	VSS	VSS	Ground
55	DQ16	DQ16	DQ16	DQ16	Data 16
56	DQ17	DQ17	DQ17	DQ17	Data 17
57	DQ18	DQ18	DQ18	DQ18	Data 18
58	DQ19	DQ19	DQ19	DQ19	Data 19
59	VCC	VCC	VCC	VCC	+5 VDC or +3.3 VDC
60	DQ20	DQ20	DQ20	DQ20	Data 20
61	n/c	n/c	n/c	n/c	Not connected
62	DU	DU	DU	DU	Don't Use
63	n/c	n/c	n/c	n/c	Not connected
64	VSS	VSS	VSS	VSS	Ground
65	DQ21	DQ21	DQ21	DQ21	Data 21
66	DQ22	DQ22	DQ22	DQ22	Data 22
67	DQ23	DQ23	DQ23	DQ23	Data 23
68	VSS	VSS	VSS	VSS	Ground
69	DQ24	DQ24	DQ24	DQ24	Data 24
70	DQ25	DQ25	DQ25	DQ25	Data 25
71	DQ26	DQ26	DQ26	DQ26	Data 26
72	DQ27	DQ27	DQ27	DQ27	Data 27
73	VCC	VCC	VCC	VCC	+5 VDC or +3.3 VDC
74	DQ28	DQ28	DQ28	DQ28	Data 28
75	DQ29	DQ29	DQ29	DQ29	Data 29
76	DQ30	DQ30	DQ30	DQ30	Data 30
77	DQ31	DQ31	DQ31	DQ31	Data 31
78	VSS	VSS	VSS	VSS	Ground
79	n/c	n/c	n/c	n/c	Not connected
80	n/c	n/c	n/c	n/c	Not connected
81	n/c	n/c	n/c	n/c	Not connected
82	SDA	SDA	SDA	SDA	Serial Data
83	SCL	SCL	SCL	SCL	Serial Clock
84	VCC	VCC	VCC	VCC	+5 VDC or +3.3 VDC

Back, Left

Pin	Non-Parity?	Parity?	72 ECC?	80 ECC?	Description
85	VSS	VSS	VSS	VSS	Ground
86	DQ32	DQ32	DQ32	DQ32	Data 32
87	DQ33	DQ33	DQ33	DQ33	Data 33
88	DQ34	DQ34	DQ34	DQ34	Data 34
89	DQ35	DQ35	DQ35	DQ35	Data 35
90	VCC	VCC	VCC	VCC	+5 VDC or +3.3 VDC
91	DQ36	DQ36	DQ36	DQ36	Data 36
92	DQ37	DQ37	DQ37	DQ37	Data 37
93	DQ38	DQ38	DQ38	DQ38	Data 38
94	DQ39	DQ39	DQ39	DQ39	Data 39

BETA RELEASE

95	DQ40	DQ40	DQ40	DQ40	Data 40
96	VSS	VSS	VSS	VSS	Ground
97	DQ41	DQ41	DQ41	DQ41	Data 41
98	DQ42	DQ42	DQ42	DQ42	Data 42
99	DQ43	DQ43	DQ43	DQ43	Data 43
100	DQ44	DQ44	DQ44	DQ44	Data 44
101	DQ45	DQ45	DQ45	DQ45	Data 45
102	VCC	VCC	VCC	VCC	+5 VDC or +3.3 VDC
103	DQ46	DQ46	DQ46	DQ46	Data 46
104	DQ47	DQ47	DQ47	DQ47	Data 47
105	n/c	CB4	CB4	CB4	Parity/Check Bit Input/Output 4
106	n/c	CB5	CB5	CB5	Parity/Check Bit Input/Output 5
107	VSS	VSS	VSS	VSS	Ground
108	n/c	n/c	n/c	CB12	Parity/Check Bit Input/Output 12
109	n/c	n/c	n/c	CB13	Parity/Check Bit Input/Output 13
110	VCC	VCC	VCC	VCC	+5 VDC or +3.3 VDC
111	DU	DU	DU	DU	Don't Use
112	/CAS4	/CAS4	/CAS4	/CAS4	Column Address Strobe 4
113	/CAS5	/CAS5	/CAS5	/CAS5	Column Address Strobe 5
114	/RAS1	/RAS1	/RAS1	/RAS1	Row Address Strobe 1
115	DU	DU	DU	DU	Don't Use
116	VSS	VSS	VSS	VSS	Ground
117	A1	A1	A1	A1	Address 1
118	A3	A3	A3	A3	Address 3
119	A5	A5	A5	A5	Address 5
120	A7	A7	A7	A7	Address 7
121	A9	A9	A9	A9	Address 9
122	A11	A11	A11	A11	Address 11
123	A13	A13	A13	A13	Address 13
124	VCC	VCC	VCC	VCC	+5 VDC or +3.3 VDC
125	DU	DU	DU	DU	Don't Use
126	DU	DU	DU	DU	Don't Use

Back, Right

Pin	Non-Parity?	Parity?	72 ECC?	80 ECC?	Description
127	VSS	VSS	VSS	VSS	Ground
128	DU	DU	DU	DU	Don't Use
129	/RAS3	/RAS3	/RAS3	/RAS3	Column Address Strobe 3
130	/CAS6	/CAS6	/CAS6	/CAS6	Column Address Strobe 6
131	/CAS7	/CAS7	/CAS7	/CAS7	Column Address Strobe 7
132	DU	DU	DU	DU	Don't Use
133	VCC	VCC	VCC	VCC	+5 VDC or +3.3 VDC
134	n/c	n/c	n/c	CB14	Parity/Check Bit Input/Output 14
135	n/c	n/c	n/c	CB15	Parity/Check Bit Input/Output 15
136	n/c	CB6	CB6	CB6	Parity/Check Bit Input/Output 6
137	n/c	CB7	CB7	CB7	Parity/Check Bit Input/Output 7
138	VSS	VSS	VSS	VSS	Ground
139	DQ48	DQ48	DQ48	DQ48	Data 48
140	DQ49	DQ49	DQ49	DQ49	Data 49
141	DQ50	DQ50	DQ50	DQ50	Data 50
142	DQ51	DQ51	DQ51	DQ51	Data 51
143	VCC	VCC	VCC	VCC	+5 VDC or +3.3 VDC
144	DQ52	DQ52	DQ52	DQ52	Data 52
145	n/c	n/c	n/c	n/c	Not connected
146	DU	DU	DU	DU	Don't Use
147	n/c	n/c	n/c	n/c	Not connected
148	VSS	VSS	VSS	VSS	Ground
149	DQ53	DQ53	DQ53	DQ53	Data 53
150	DQ54	DQ54	DQ54	DQ54	Data 54

BETA RELEASE

151	DQ55	DQ55	DQ55	DQ55	Data 55
152	VSS	VSS	VSS	VSS	Ground
153	DQ56	DQ56	DQ56	DQ56	Data 56
154	DQ57	DQ57	DQ57	DQ57	Data 57
155	DQ58	DQ58	DQ58	DQ58	Data 58
156	DQ59	DQ59	DQ59	DQ59	Data 59
157	VCC	VCC	VCC	VCC	+5 VDC or +3.3 VDC
158	DQ60	DQ60	DQ60	DQ60	Data 60
159	DQ61	DQ61	DQ61	DQ61	Data 61
160	DQ62	DQ62	DQ62	DQ62	Data 62
161	DQ63	DQ63	DQ63	DQ63	Data 63
162	VSS	VSS	VSS	VSS	Ground
163	CK3	CK3	CK3	CK3	
164	n/c	n/c	n/c	n/c	Not connected
165	SA0	SA0	SA0	SA0	Serial Address 0
166	SA1	SA1	SA1	SA1	Serial Address 1
167	SA2	SA2	SA2	SA2	Serial Address 2
168	VCC	VCC	VCC	VCC	+5 VDC or +3.3 VDC

Contributor: Joakim Ögren <qtech@mailhost.net>, Mark Brown <bugman@total.net>

Source: Various productsheets at IBM Memory Products <<http://www.chips.ibm.com/products/memory/>>

Please send any comments to Joakim Ögren <qtech@mailhost.net>.

PRELIMINARY BETA. NOT FOR RE-DISTRIBUTION.

168 pin SDRAM DIMM (Unbuffered)

DIMM=Dual Inline Memory Module

**NOT
DRAWN
YET...**



(At the computer)

168 PIN DIMM at the computer.

Front Side (left side 1-42, right side 43-84)

Back Side (left side 85-126, right side 127-168)

Front, Left

Pin	Non-Parity	72 ECC?	80 ECC?	Description
1	VSS	VSS	VSS	Ground
2	DQ0	DQ0	DQ0	Data 0
3	DQ1	DQ1	DQ1	Data 1
4	DQ2	DQ2	DQ2	Data 2
5	DQ3	DQ3	DQ3	Data 3
6	VDD	VDD	VDD	+5 VDC or +3.3 VDC
7	DQ4	DQ4	DQ4	Data 4
8	DQ5	DQ5	DQ5	Data 5
9	DQ6	DQ6	DQ6	Data 6
10	DQ7	DQ7	DQ7	Data 7
11	DQ8	DQ8	DQ8	Data 8
12	VSS	VSS	VSS	Ground
13	DQ9	DQ9	DQ9	Data 9
14	DQ10	DQ10	DQ10	Data 10
15	DQ11	DQ11	DQ11	Data 11
16	DQ12	DQ12	DQ12	Data 12
17	DQ13	DQ13	DQ13	Data 13
18	VDD	VDD	VDD	+5 VDC or +3.3 VDC
19	DQ14	DQ14	DQ14	Data 14
20	DQ15	DQ15	DQ15	Data 15
21	n/c	CB0	CB0	Parity/Check Bit Input/Output 0
22	n/c	CB1	CB1	Parity/Check Bit Input/Output 01
23	VSS	VSS	VSS	Ground
24	n/c	n/c	CB8	Parity/Check Bit Input/Output 8
25	n/c	n/c	CB9	Parity/Check Bit Input/Output 9
26	VDD	VDD	VDD	+5 VDC or +3.3 VDC
27	/WE	/WE	/WE	Read/Write
28	DQMB0	DQMB0	DQMB0	Byte Mask signal 0
29	DQMB1	DQMB1	DQMB1	Byte Mask signal 1
30	/S0	/S0	/S0	Chip Select 0
31	DU	DU	DU	Don't Use
32	VSS	VSS	VSS	Ground
33	A0	A0	A0	Address 0
34	A2	A2	A2	Address 2
35	A4	A4	A4	Address 4
36	A6	A6	A6	Address 6
37	A8	A8	A8	Address 8
38	A10/AP	A10/AP	A10/AP	Address 10
39	BA1	BA1	BA1	Bank Address 1
40	VDD	VDD	VDD	+5 VDC or +3.3 VDC
41	VDD	VDD	VDD	+5 VDC or +3.3 VDC
42	CK0	CK0	CK0	Clock signal 0

BETA RELEASE

Front, Right

Pin	Non-Parity	72 ECC?	80 ECC?	Description
43	VSS	VSS	VSS	Ground
44	DU	DU	DU	Don't Use
45	/S2	/S2	/S2	Chip Select 2
46	DQMB2	DQMB2	DQMB2	Byte Mask signal 2
47	DQMB3	DQMB3	DQMB3	Byte Mask signal 3
48	DU	DU	DU	Don't Use
49	VDD	VDD	VDD	+5 VDC or +3.3 VDC
50	n/c	n/c	CB10	Parity/Check Bit Input/Output 10
51	n/c	n/c	CB11	Parity/Check Bit Input/Output 11
52	n/c	CB2	CB2	Parity/Check Bit Input/Output 2
53	n/c	CB3	CB3	Parity/Check Bit Input/Output 3
54	VSS	VSS	VSS	Ground
55	DQ16	DQ16	DQ16	Data 16
56	DQ17	DQ17	DQ17	Data 17
57	DQ18	DQ18	DQ18	Data 18
58	DQ19	DQ19	DQ19	Data 19
59	VDD	VDD	VDD	+5 VDC or +3.3 VDC
60	DQ20	DQ20	DQ20	Data 20
61	n/c	n/c	n/c	Not connected
62	Vref,NC	Vref,NC	Vref,NC	
63	CKE1	CKE1	CKE1	Clock Enable Signal 1
64	VSS	VSS	VSS	Ground
65	DQ21	DQ21	DQ21	Data 21
66	DQ22	DQ22	DQ22	Data 22
67	DQ23	DQ23	DQ23	Data 23
68	VSS	VSS	VSS	Ground
69	DQ24	DQ24	DQ24	Data 24
70	DQ25	DQ25	DQ25	Data 25
71	DQ26	DQ26	DQ26	Data 26
72	DQ27	DQ27	DQ27	Data 27
73	VDD	VDD	VDD	+5 VDC or +3.3 VDC
74	DQ28	DQ28	DQ28	Data 28
75	DQ29	DQ29	DQ29	Data 29
76	DQ30	DQ30	DQ30	Data 30
77	DQ31	DQ31	DQ31	Data 31
78	VSS	VSS	VSS	Ground
79	CK2	CK2	CK2	Clock signal 2
80	n/c	n/c	n/c	Not connected
81	n/c	n/c	n/c	Not connected
82	SDA	SDA	SDA	Serial Data
83	SCL	SCL	SCL	Serial Clock
84	VDD	VDD	VDD	+5 VDC or +3.3 VDC

Back, Left

Pin	Non-Parity	72 ECC?	80 ECC?	Description
85	VSS	VSS	VSS	Ground
86	DQ32	DQ32	DQ32	Data 32
87	DQ33	DQ33	DQ33	Data 33
88	DQ34	DQ34	DQ34	Data 34
89	DQ35	DQ35	DQ35	Data 35
90	VDD	VDD	VDD	+5 VDC or +3.3 VDC
91	DQ36	DQ36	DQ36	Data 36
92	DQ37	DQ37	DQ37	Data 37
93	DQ38	DQ38	DQ38	Data 38
94	DQ39	DQ39	DQ39	Data 39

BETA RELEASE

95	DQ40	DQ40	DQ40	Data 40
96	VSS	VSS	VSS	Ground
97	DQ41	DQ41	DQ41	Data 41
98	DQ42	DQ42	DQ42	Data 42
99	DQ43	DQ43	DQ43	Data 43
100	DQ44	DQ44	DQ44	Data 44
101	DQ45	DQ45	DQ45	Data 45
102	VDD	VDD	VDD	+5 VDC or +3.3 VDC
103	DQ46	DQ46	DQ46	Data 46
104	DQ47	DQ47	DQ47	Data 47
105	n/c	CB4	CB4	Parity/Check Bit Input/Output 4
106	n/c	CB5	CB5	Parity/Check Bit Input/Output 5
107	VSS	VSS	VSS	Ground
108	n/c	n/c	CB12	Parity/Check Bit Input/Output 12
109	n/c	n/c	CB13	Parity/Check Bit Input/Output 13
110	VDD	VDD	VDD	+5 VDC or +3.3 VDC
111	/CAS	/CAS	/CAS	Column Address Strobe
112	DQMB4	DQMB4	DQMB4	Byte Mask signal 4
113	DQMB5	DQMB5	DQMB5	Byte Mask signal 5
114	/S1	/S1	/S1	Chip Select 1
115	/RAS	/RAS	/RAS	Row Address Strobe
116	VSS	VSS	VSS	Ground
117	A1	A1	A1	Address 1
118	A3	A3	A3	Address 3
119	A5	A5	A5	Address 5
120	A7	A7	A7	Address 7
121	A9	A9	A9	Address 9
122	BA0	BA0	BA0	Bank Address 0
123	A11	A11	A11	Address 11
124	VDD	VDD	VDD	+5 VDC or +3.3 VDC
125	CK1	CK1	CK1	Clock signal 1
126	A12	A12	A12	Address 12

Back, Right

Pin	Non-Parity	72 ECC?	80 ECC?	Description
127	VSS	VSS	VSS	Ground
128	CKE0	CKE0	CKE0	Clock Enable Signal 0
129	/S3	/S3	/S3	Chip Select 3
130	DQMB6	DQMB6	DQMB6	Byte Mask signal 6
131	DQMB7	DQMB7	DQMB7	Byte Mask signal 7
132	A13	A13	A13	Address 13
133	VDD	VDD	VDD	+5 VDC or +3.3 VDC
134	n/c	n/c	CB14	Parity/Check Bit Input/Output 14
135	n/c	n/c	CB15	Parity/Check Bit Input/Output 15
136	n/c	CB6	CB6	Parity/Check Bit Input/Output 6
137	n/c	CB7	CB7	Parity/Check Bit Input/Output 7
138	VSS	VSS	VSS	Ground
139	DQ48	DQ48	DQ48	Data 48
140	DQ49	DQ49	DQ49	Data 49
141	DQ50	DQ50	DQ50	Data 50
142	DQ51	DQ51	DQ51	Data 51
143	VDD	VDD	VDD	+5 VDC or +3.3 VDC
144	DQ52	DQ52	DQ52	Data 52
145	n/c	n/c	n/c	Not connected
146	Vref,NC	Vref,NC	Vref,NC	Not connected
147	n/c	n/c	n/c	Not connected
148	VSS	VSS	VSS	Ground
149	DQ53	DQ53	DQ53	Data 53
150	DQ54	DQ54	DQ54	Data 54

BETA RELEASE

151	DQ55	DQ55	DQ55	Data 55
152	VSS	VSS	VSS	Ground
153	DQ56	DQ56	DQ56	Data 56
154	DQ57	DQ57	DQ57	Data 57
155	DQ58	DQ58	DQ58	Data 58
156	DQ59	DQ59	DQ59	Data 59
157	VDD	VDD	VDD	+5 VDC or +3.3 VDC
158	DQ60	DQ60	DQ60	Data 60
159	DQ61	DQ61	DQ61	Data 61
160	DQ62	DQ62	DQ62	Data 62
161	DQ63	DQ63	DQ63	Data 63
162	VSS	VSS	VSS	Ground
163	CK3	CK3	CK3	Clock signal 3
164	n/c	n/c	n/c	Not connected
165	SA0	SA0	SA0	Serial address 0
166	SA1	SA1	SA1	Serial address 1
167	SA2	SA2	SA2	Serial address 2
168	VDD	VDD	VDD	+5 VDC or +3.3 VDC

Contributor: Joakim Ögren <qtech@mailhost.net>

Source: Various productsheets at IBM Memory Products <<http://www.chips.ibm.com/products/memory/>>

Please send any comments to Joakim Ögren <qtech@mailhost.net>.

PRELIMINARY BETA. NOT FOR RELISTRIIBUTION.

Please send any comments to Joakim Ögren <qtech@mailhost.net>.

The Hardware Book is freely distributable but is copyrighted to Joakim Ögren. It may not be modified and re-distributed without the authors permission.

PRELIMINARY BETA. NOT FOR REDISTRIBUTION.

BETA RELEASE

SmartCard AFNOR

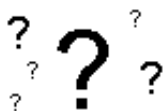
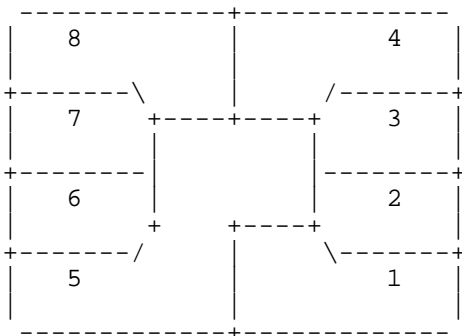

(At the card)

UNKNOWN CONNECTOR at the card.

Pin Name	Description
1	VCC +5 VDC
2	R/W Read/Write
3	CLOCK Clock
4	RESET Reset
5	GND Ground
6	VPP +21 VDC
7	I/O In/Out
8	FUSE Fuse

Contributor: Joakim Ögren <qtech@mailhost.net>

Source: Telecard/Smartcard Technical Spec & Info <<http://www.physic.ut.ee/~kalev/smartcar.txt>> by Stephane Bausson <sbausson@ensem.u-nancy.fr>

Please send any comments to Joakim Ögren <qtech@mailhost.net>.

SmartCard ISO 7816-2

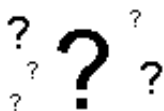
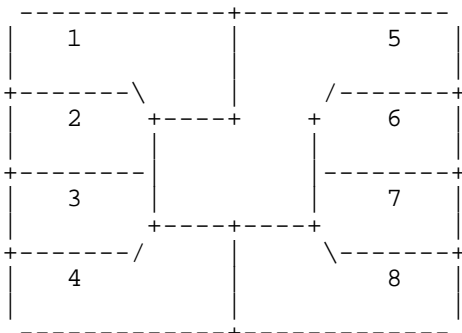

(At the card)

UNKNOWN CONNECTOR at the card.

Pin Name	Description
1	VCC +5 VDC
2	RESET Reset
3	CLOCK Clock
4	n/c Not connected
5	GND Ground
6	n/c Not connected
7	I/O In/Out
8	n/c Not connected

Contributor: Joakim Ögren <qtech@mailhost.net>

Source: Telecard/Smartcard Technical Spec & Info <<http://www.physic.ut.ee/~kalev/smartcar.txt>> by Stephane Bausson <sbausson@ensem.u-nancy.fr>

Please send any comments to Joakim Ögren <qtech@mailhost.net>.

SmartCard ISO

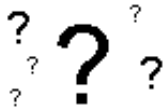
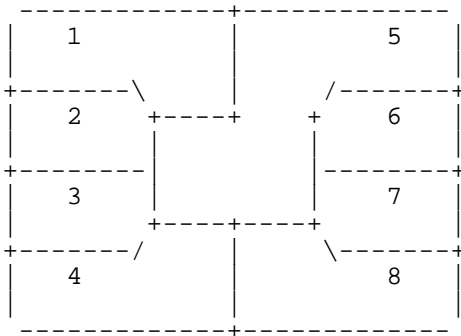

(At the card)

UNKNOWN CONNECTOR at the card.

Pin Name	Description
1	VCC +5 VDC
2	R/W Read/Write
3	CLOCK Clock
4	RESET Reset
5	GND Ground
6	VPP +21 VDC
7	I/O In/Out
8	FUSE Fuse

SmartCard ISO 7816-2

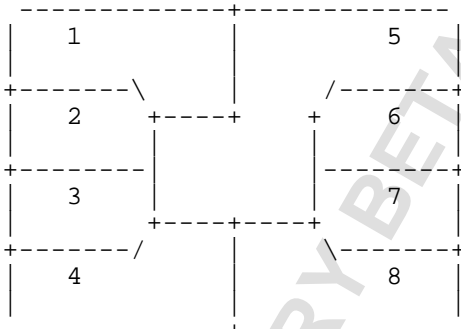

Pin Name	Description
1	VCC +5 VDC
2	RESET Reset
3	CLOCK Clock
4	n/c Not connected
5	GND Ground
6	n/c Not connected
7	I/O In/Out
8	n/c Not connected

Contributor: Joakim Ögren <qtech@mailhost.net>

Source: Telecard/Smartcard Technical Spec & Info <<http://www.physic.ut.ee/~kalev/smartcar.txt>> by Stephane Bausson <sbausson@ensem.u-nancy.fr>

Please send any comments to Joakim Ögren <qtech@mailhost.net>.

SCART

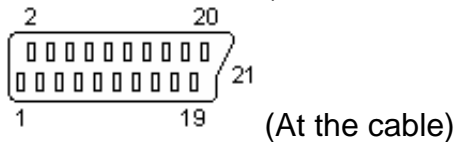
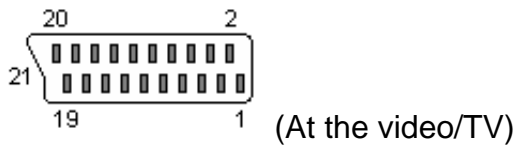

21 PIN SCART FEMALE at the Video/TV.
21 PIN SCART MALE at the Cable.

Pin Name	Description	Signal Level	Impeda
1 AOR	Audio Out Right	0.5 V rms	<1k ohm
2 AIR	Audio In Right	0.5 V rms	>10k ohm
3 AOL	Audio Out Left + Mono	0.5 V rms	<1k ohm
4 AGND	Audio Ground		
5 B GND	RGB Blue Ground		
6 AIL	Audio In Left + Mono	0.5 V rms	>10k ohm
7 B	RGB Blue In	0.7 V	75 ohm
8 SWITCH	Audio/RGB switch / 16:9		
9 G GND	RGB Green Ground		
10 CLKOUT	Data 2: Clockpulse Out (Unavailble ??)		
11 G	RGB Green In	0.7 V	75 ohm
12 DATA	Data 1: Data Out (Unavailble ??)		
13 R GND	RGB Red Ground		
14 DATAGND	Data Ground		
15 R	RGB Red In / Chrominance	0.7 V (Chrom.: 0.3 V burst)	75 ohm
16 BLNK	Blanking Signal	1-3 V=RGB, 0-0.4 V=Composite	75 ohm
17 VGND	Composite Video Ground		
18 BLNKGND	Blanking Signal Ground		
19 VOUT	Composite Video Out	1 V	75 ohm
20 VIN	Composite Video In / Luminance	1 V	75 ohm
21 SHIELD	Ground/Shield (Chassis)		

Contributor: Joakim Ögren <qtech@mailhost.net>

Source: Various sources, Video Demystified at Keith Jack's pages
<<http://www.mindspring.com/~kjack1/scart.html>>

Please send any comments to Joakim Ögren <qtech@mailhost.net>.

S-Video



(At the peripheral)

4 PIN MINI-DIN FEMALE at the peripheral.

Pin	Name	Description
-----	------	-------------

1	GND	Ground (Y)
2	GND	Ground (C)
3	Y	Intensity (Luminance)
4	C	Color (Chrominance)

Contributor: Joakim Ögren <qtech@mailhost.net>

Source: Video Demystified at Keith Jack's pages <<http://www.mindspring.com/~kjack1/svideo.html>>

Please send any comments to Joakim Ögren <qtech@mailhost.net>.

DIN Audio

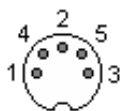

(At the peripheral)

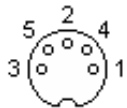

(At the cable)

5 PIN DIN 180° (DIN41524) FEMALE at the peripheral.

5 PIN DIN 180° (DIN41524) MALE at the cable.

Peripheral	Connected	In L	In R	Out L	Out R	Ground
Amplifier	Pickup, tuner	3	5			2
Amplifier	Taperecorder	3	5	1	4	2
Tuner	Amplifier			3	5	2
Tuner	Taperecorder			1	4	2
Recordplayer	Amplifier			3	5	2
Taperecorder	Amplifier	1	4	3	5	2
Taperecorder	Receiver	1	4	3	5	2
Taperecorder	Microphone	1	4			2

Contributor: Joakim Ögren <qtech@mailhost.net>

Source: ELFA <http://www.elfa.se>'s catalog Nr 44

Please send any comments to Joakim Ögren <qtech@mailhost.net>

3.5 mm Mono Telephone plug

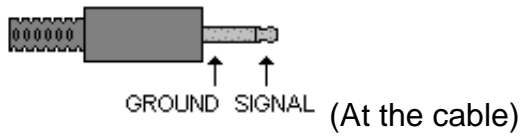

3.5 mm MONO TELEPHONE MALE at the cable.

Name	Description
SIGNAL	Signal
GROUND	Ground

Contributor: Joakim Ögren <qtech@mailhost.net>

Source: ?

Please send any comments to Joakim Ögren <qtech@mailhost.net>.

3.5 mm Stereo Telephone plug

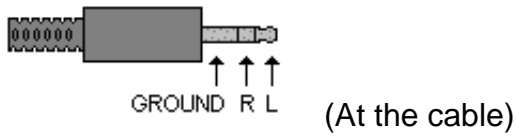

3.5 mm STEREO TELEPHONE MALE at the cable.

Name	Description
L	Left Signal
R	Right Signal
GROUND	Ground

Contributor: Joakim Ögren <qtech@mailhost.net>, Uwe Hartmann <uhartmann@i-stud.htw-zittau.de>

Source: ?

Please send any comments to Joakim Ögren <qtech@mailhost.net>.

6.25 mm Mono Telephone plug

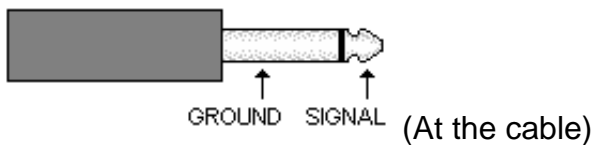

6.25 mm MONO TELEPHONE MALE at the cable.

Name	Description
SIGNAL	Signal
GROUND	Ground

Contributor: Joakim Ögren <qtech@mailhost.net>

Source: ?

Please send any comments to Joakim Ögren <qtech@mailhost.net>.

PRELIMINARY BETA. NOT FOR REDISTRIBUTION.

6.25 mm Stereo Telephone plug

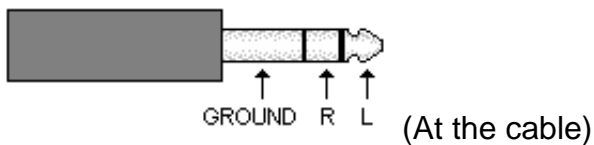

6.25 mm STEREO TELEPHONE MALE at the cable.

Name	Description
L	Left Signal
R	Right Signal
GROUND	Ground

Contributor: Joakim Ögren <qtech@mailhost.net>

Source: ?

Please send any comments to Joakim Ögren <qtech@mailhost.net>.

5.25" Power

Used for harddisks & 5.25" peripherals.

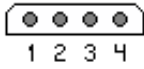

(At the powersupply cable)

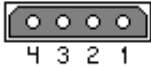

(At the peripheral)

UNKNOWN CONNECTOR at the powersupply cable.

UNKNOWN CONNECTOR at the peripheral.

Pin Name	Color	Description
1 +12V	Yellow	+12 VDC
2 GND	Black	+12 V Ground (Same as +5 V Ground)
3 GND	Black	+5 V Ground
4 +5V	Red	+5 VDC

Contributors: Joakim Ögren <qtech@mailhost.net>, Eric Sprigg <Eric_Sprigg@compuserve.com>, Sven Gunnar Bilen <sbilen@umich.edu>, Scott Lindenthaler <scott@teraflop.com>

Source: ?

Please send any comments to Joakim Ögren <qtech@mailhost.net>.

3.5" Power

Used for floppies.

NOT

DRAWN

YET...



(At the powersupply cable)

NOT

DRAWN

YET...



(At the peripheral)

UNKNOWN CONNECTOR at the powersupply cable.

UNKNOWN CONNECTOR at the peripheral.

Pin Name	Color	Description
1 +5V	Red	+5 VDC
2 GND	Black	+5 V Ground
3 GND	Black	+12 V Ground (Same as +5 V Ground)
4 +12V	Yellow	+12 VDC

Contributor: Joakim Ögren <qtech@mailhost.net>

Source: ?

Please send any comments to Joakim Ögren <qtech@mailhost.net>.



Motherboard Power

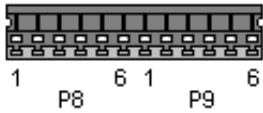

(At the Computer)

**NOT
DRAWN
YET...**



(At the Powersupply cables)

2x MOLEX 15-48-0106 CONNECTOR at the Computer.

2x MOLEX 90331-0001 CONNECTOR at the Powersupply cables.

P8

Pin Name	Color	Description
1 PG	Orange	Power Good, +5 VDC when all voltages has stabilized.
2 +5V	Red	+5 VDC (or n/c)
3 +12V	Yellow	+12 VDC
4 -12V	Blue	-12 VDC
5 GND	Black	Ground
6 GND	Black	Ground

P9

Pin Name	Color	Description
1 GND	Black	Ground
2 GND	Black	Ground
3 -5V	White or Yellow	-5 VDC
4 +5V	Red	+5 VDC
5 +5V	Red	+5 VDC
6 +5V	Red	+5 VDC

Note: Pins part number is 08-50-0276, Product specification is PS-90331.

Contributor: Joakim Ögren <qtech@mailhost.net>, Bill Shepherd <contrav@usaor.net>

Source: ?

Please send any comments to Joakim Ögren <qtech@mailhost.net>.

Turbo LED

**NOT
DRAWN
YET...** 

(At the computer)

UNKNOWN CONNECTOR at the computer.

Pin Name Description

1	+5V	+5 VDC
2	/HS	HighSpeed
3	+5V	+5 VDC

Contributor: Joakim Ögren <qtech@mailhost.net>

Source: ?

Please send any comments to Joakim Ögren <qtech@mailhost.net>.

AT Backup Battery

**NOT
DRAWN
YET...** 

(At the computer)

UNKNOWN CONNECTOR at the computer.

Pin Name	Description
----------	-------------

1	BATT+ Battery+
2	key Key
3	GND Ground
4	GND Ground

Contributor: Joakim Ögren <qtech@mailhost.net>

Source: ?

Please send any comments to Joakim Ögren <qtech@mailhost.net>.

PRELIMINARY BETA. NOT FOR REDISTRIBUTION.

AT LED/Keylock

**NOT
DRAWN
YET...** 

(At the computer)

UNKNOWN CONNECTOR at the computer.

Pin Name Description

1	LED	LED Power
2	GND	Ground
3	GND	Ground
4	KS	Key Switch
5	GND	Ground

Contributor: Joakim Ögren <qtech@mailhost.net>

Source: ?

Please send any comments to Joakim Ögren <qtech@mailhost.net>.

PRELIMINARY BETA. NOT FOR REDISTRIBUTION.

PC Speaker

**NOT
DRAWN
YET...** 

(At the computer)

UNKNOWN CONNECTOR at the computer.

Pin Name	Description
1 -SP	-Speaker
2 key	Key
3 GND	Ground
4 +SP5V	+Speaker +5 VDC

Contributor: Joakim Ögren <qtech@mailhost.net>

Source: ?

Please send any comments to Joakim Ögren <qtech@mailhost.net>.

PRELIMINARY BETA. NOT FOR REDISTRIBUTION.

Motherboard IrDA

For motherboards with a IrDA compliant Infrared Module connector.

1 2 3 4 5
· · · · ·

5 PIN IDC MALE at the motherboard.

Pin Name Description

1	+5v	Power
2	n/c	Not connected
3	IRRX	IR Module data received
4	GND	System GND
5	IRTX	IR Module data transmit

Contributor: Rob Gill <gillz@mpx.com.au>

Source: ASUS motherboard manual

Please send any comments to Joakim Ögren <qtech@mailhost.net>

PRELIMINARY BETA. NOT FOR REDISTRIBUTION.

Motherboard CPU Cooling fan

1 2 3
· · ·

3 PIN IDC MALE at the motherboard

Pin Name

1 GND
2 +12V
3 GND

Contributor: Rob Gill <gillz@mpx.com.au>

Source: ASUS Motherboard Manual

Please send any comments to Joakim Ögren <qtech@mailhost.net>

PRELIMINARY BETA. NOT FOR REDISTRIBUTION.

Ethernet 10/100Base-T

Same connector and pinout for both 10Base-T and 100Base-TX.

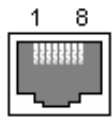

(At the network interface cards/hubs)

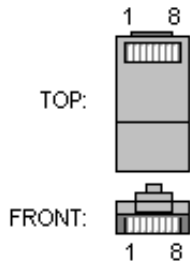

(At the cables)

RJ45 FEMALE CONNECTOR at the network interface cards/hubs.
RJ45 MALE CONNECTOR at the cables.

Pin Name Description

1	TX+	Transceive Data+
2	TX-	Transceive Data-
3	RX+	Receive Data+
4	n/c	Not connected
5	n/c	Not connected
6	RX-	Receive Data-
7	n/c	Not connected
8	n/c	Not connected

Note: TX & RX are swapped on Hub's.

Contributor: Joakim Ögren <qtech@mailhost.net>, Jeffrey R. Broido <broidoj@gti.net>

Source: ?

Please send any comments to Joakim Ögren <qtech@mailhost.net>.

Ethernet 100Base-T4

100Base-T4 uses all four pairs. 100Base-TX only uses two pairs.

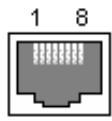

(At the network interface cards/hubs)

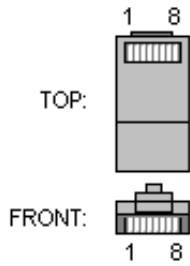

(At the cables)

RJ45 FEMALE CONNECTOR at the network interface cards/hubs.
RJ45 MALE CONNECTOR at the cables.

Pin Name	Description
1 TX_D1+	Transceive Data+
2 TX_D1-	Transceive Data-
3 RX_D2+	Receive Data+
4 BI_D3+	Bi-directional Data+
5 BI_D3-	Bi-directional Data-
6 RX_D2-	Receive Data-
7 BI_D4+	Bi-directional Data+
8 BI_D4-	Bi-directional Data-

Note: TX & RX are swapped on Hub's. Don't know about Bi-directional data.

Contributor: Joakim Ögren <qtech@mailhost.net>, Kim Scholte <KScholte@BigFoot.Com>

Source: ?

Please send any comments to Joakim Ögren <qtech@mailhost.net>.

AUI

Is the directions right???

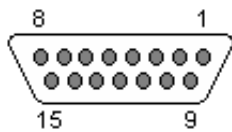

(At the Ethernet card)

15 PIN D-SUB FEMALE at the Ethernet card.

Pin Description

- 1 control in circuit shield
- 2 control in circuit A
- 3 data out circuit A
- 4 data in circuit shield
- 5 data in circuit A
- 6 voltage common
- 7 ?
- 8 control out circuit shield
- 9 control in circuit B
- 10 data out circuit B
- 11 data out circuit shield
- 12 data in circuit B
- 13 voltage plus
- 14 voltage shield
- 15 ?

Contributor: Joakim Ögren <qtech@mailhost.net>

Source: Tommy's pinout Collection <<http://csgrad.cs.vt.edu/~tjohnson/pinouts>> by Tommy Johnson <tjohnson@csgrad.cs.vt.edu>

Please send any comments to Joakim Ögren <qtech@mailhost.net>.

Atari 2600 Cartridge

					Top							
D3	D4	D5	D6	D7	A12	A10	A11	A9	A8	+5V	SGND	
--1-	--2-	--3-	--4-	--5-	--6-	--7-	--8-	--9-	-10-	-11-	-12-	
GND	D2	D1	D0	A0	A1	A2	A3	A4	A5	A6	A7	
					Bottom							

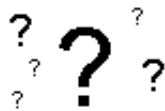

(At the Atari)

UNKNOWN CONNECTOR at the Atari.

Connect a 2716 or 2732/2532 EPROM.

Top Row

Pin	2716 Pin	CPU Name	Description
1	13	D3	Data 3
2	14	D4	Data 4
3	15	D5	Data 5
4	16	D6	Data 6
5	17	D7	Data 7
6	*	A12	Address 12
7	19	A10	Address 10
8	n/c	A11	Address 11
9	22	A9	Address 9
10	23	A8	Address 8
11	24	+5V	+5 VDC
12	12	SGND	Shield Ground

* to inverter and back to 18 for chip select

Bottom Row

Pin	2716 Pin	CPU Name	Description
1	1	A7	Address 7
2	2	A6	Address 6
3	3	A5	Address 5
4	4	A4	Address 4
5	5	A3	Address 3
6	6	A2	Address 2
7	7	A1	Address 1
8	8	A0	Address 0
9	9	D0	Data 0
10	10	D1	Data 1
11	11	D2	Data 2
12	n/c	GND	Ground

Contributor: Joakim Ögren <qtech@mailhost.net>

Source: Classic Atari 2600/5200/7800 Game Systems FAQ
<<http://www.dhp.com/~sloppy/files/classic/atari/atari.faq>>

Please send any comments to Joakim Ögren <qtech@mailhost.net>.

Atari 5200 Cartridge

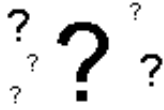

(At the Atari)

UNKNOWN CONNECTOR at the Atari.

Pin Name

1	D0
2	D1
3	D2
4	D3
5	D4
6	D5
7	D6
8	D7
9	Enable 80-8F
10	Enable 40-7F
11	Not Connected
12	Ground
13	Ground
14	Ground (System Clock 02 on 2 port)
15	A6
16	A5
17	A2
18	Interlock
19	A0
20	A1
21	A3
22	A4
23	Ground
24	Ground (Video In on 2 port)
25	Ground
26	+5 VDC
27	A7
28	Not Connected
29	A8
30	Audio In (2 port)
31	A9
32	A13
33	A10
34	A12
35	A11
36	Interlock

Contributor: Joakim Ögren <qtech@mailhost.net>

Source: Classic Atari 2600/5200/7800 Game Systems FAQ
<<http://www.dhp.com/~sloppy/files/classic/atari/atari.faq>>

Please send any comments to Joakim Ögren <qtech@mailhost.net>.

Atari 5200 Expansion

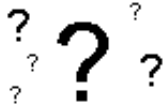

(At the Atari)

UNKNOWN CONNECTOR at the Atari.

Pin Name

- 1 +5 VDC
- 2 Audio Out (2 port)
- 3 Ground
- 4 R/W Early
- 5 Enable E0-EF
- 6 D6
- 7 D4
- 8 D2
- 9 D0
- 10 IRQ
- 11 Ground
- 12 Serial Data In
- 13 Serial In Clock
- 14 Serial Out Clock
- 15 Serial Data Out
- 16 Audio In
- 17 A14
- 18 System Clock 01
- 19 A11
- 20 A7
- 21 A6
- 22 A5
- 23 A4
- 24 A3
- 25 A2
- 26 A1
- 27 A0
- 28 Ground
- 29 D1
- 30 D3
- 31 D5
- 32 D7
- 33 Not connected
- 34 Ground
- 35 Not connected
- 36 +5 VDC

Contributor: Joakim Ögren <qtech@mailhost.net>

Source: Classic Atari 2600/5200/7800 Game Systems FAQ
<<http://www.dhp.com/~sloppy/files/classic/atari/atari.faq>>

Please send any comments to Joakim Ögren <qtech@mailhost.net>.

Atari 7800 Cartridge

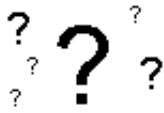

(At the Atari)

UNKNOWN CONNECTOR at the Atari.

Pin	Name	Description
1	R/W	Read/Write
2	HALT	Halt
3	D3	Data 3
4	D4	Data 4
5	D5	Data 5
6	D6	Data 6
7	D7	Data 7
8	A12	Address 12
9	A10	Address 10
10	A11	Address 11
11	A9	Address 9
12	A8	Address 8
13	+5V	+5 VDC
14	GND	Ground
15	A13	Address 13
16	A14	Address 14
17	A15	Address 15
18	EAUDIO	EAudio ???
19	A7	Address 7
20	A6	Address 6
21	A5	Address 5
22	A4	Address 4
23	A3	Address 3
24	A2	Address 2
25	A1	Address 1
26	A0	Address 0
27	D0	Data 0
28	D1	Data 1
29	D2	Data 2
30	Gnd	Gnd
31	IRQ	Interrupt
32	CLK2	Clock 2 ???

Contributor: Joakim Ögren <qtech@mailhost.net>

Source: Classic Atari 2600/5200/7800 Game Systems FAQ
<<http://www.dhp.com/~sloppy/files/classic/atari/atari.faq>>

Please send any comments to Joakim Ögren <qtech@mailhost.net>.

Atari 7800 Expansion

```

Gnd   +5v   CVideo MLum0 MLum3 Blank OscDis ExtMen Gnd
--1-- --2--  --3--  --4--  --5--  --6--  --7--  --8--  --9--

-18-- -17--  -16-- -15-- -14-- -13-- -12--  -11-- -10--
Gnd  Audio   Rdy   MCol MLum2 MLum1 Msync  Clk2  ExtOsc

```

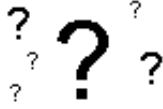

(At the Atari)

UNKNOWN CONNECTOR at the Atari.

Pin Name	Description
1 GND	Ground
2 +5V	+5 VDC
3 CVIDEO	Input to RF modulator (Video+Audio)
4 MLUM0	Maria Luminance Bit 0
5 MLUM3	Maria Luminance Bit 3
6 BLANK	Blanking output
7 OSCDIS	Disable 14.31818 MHz Master Clock
8 EXTMEN	External Maria Enable Input
9 GND	Ground
10 EXTOSC	External clock to replace Master Clock
11 CLK2	Phase 2 Clock from the 6502
12 MSYNC	Maria Composite Sync
13 MLUM1	Maria Luminance Bit 1
14 MLUM2	Maria Luminance Bit 2
15 MCOL	Maria Color Phase Angle
16 RDY	Input to the 6502
17 AUDIO	Audio
18 GND	Ground

Contributor: Joakim Ögren <qtech@mailhost.net>

Source: Classic Atari 2600/5200/7800 Game Systems FAQ
<<http://www.dhp.com/~sloppy/files/classic/atari/atari.faq>>, Pinout by Harry Dodgson

Please send any comments to Joakim Ögren <qtech@mailhost.net>.

Atari Cartridge Port

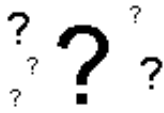

(At the Computer)

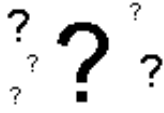

(At the Devices)

40 PIN EDGE ?? at the Computer.

40 PIN EDGE ?? at the Devices.

Pin Name Description

1	+5V	+5 VDC
2	+5V	+5 VDC
3	D14	Data 14
4	D15	Data 15
5	D12	Data 12
6	D13	Data 13
7	D10	Data 10
8	D11	Data 11
9	D8	Data 8
10	D9	Data 9
11	D6	Data 6
12	D7	Data 7
13	D4	Data 4
14	D5	Data 5
15	D2	Data 2
16	D3	Data 3
17	D0	Data 0
18	D1	Data 1
19	A13	Address 13
20	A15	Address 15
21	A8	Address 8
22	A14	Address 14
23	A7	Address 7
24	A9	Address 9
25	A6	Address 6
26	A10	Address 10
27	A5	Address 5
28	A12	Address 12
29	A11	Address 11
30	A4	Address 4
31	RS3	ROM Select 3
32	A3	Address 3
33	RS4	ROM Select 4
34	A2	Address 2
35	UDS	Upper Data Strobe
36	A1	Address 1
37	LDS	Lower Data Strobe
38	GND	Ground
39	GND	Ground
40	GND	Ground

Contributor: Joakim Ögren <qtech@mailhost.net>, Lawrence Wright <lwright@silk.net>, Steve & Sally Blair <blair@mailbox.uq.edu.au>

Source: ?

Please send any comments to Joakim Ögren <qtech@mailhost.net>.

The Hardware Book is freely distributable but is copyrighted to Joakim Ögren. It may not be modified and re-distributed without the authors permission.

PRELIMINARY BETA. NOT FOR REDISTRIBUTION.

BETA RELEASE

GameBoy Cartridge

Available on the Nintendo GameBoy.

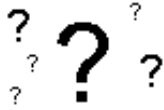

(At the GameBoy)

UNKNOWN CONNECTOR at the GameBoy.

Pin	Name	Description
1	VCC	+5 VDC
2	?	? Connected on Gameboy, but not used on GamePaks.
3	/RESET	Reset
4	/WR	Write
5	?	? Used by paging PAL on high capacity GamePaks.
6	A0	Address 0
7	A1	Address 1
8	A2	Address 2
9	A3	Address 3
10	A4	Address 4
11	A5	Address 5
12	A6	Address 6
13	A7	Address 7
14	A8	Address 8
15	A9	Address 9
16	A10	Address 10
17	A11	Address 11
18	A12	Address 12
19	A13	Address 13
20	A14	Address 14
21	/CS	Chip Select
22	D0	Data 0
23	D1	Data 1
24	D2	Data 2
25	D3	Data 3
26	D4	Data 4
27	D5	Data 5
28	D6	Data 6
29	D7	Data 7
30	/RD	Read
31	?	? Connected on Gameboy, but not used on Game-Paks.
32	GND	Ground

Contributor: Joakim Ögren <qtech@mailhost.net>

Source: Nintendo GameBoy FAQ <<http://www.freeflight.com/fms/stuff/gameboy.faq>>, Pinout by Peter Knight & Josef Mollers

Please send any comments to Joakim Ögren <qtech@mailhost.net>.

MSX Expansion

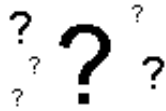
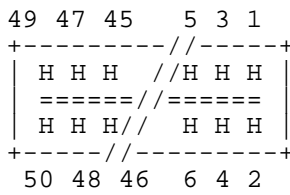

(At the Computer)

50 PIN ?? at the Computer.

Pin Name	Dir	Description
1 /CS1	→	Memory Read in addresses 4000-7FFF
2 /CS2	→	Memory Read in addresses 8000-BFFF
3 /CS12	→	Memory Read in addresses 4000-BFFF
4 /SLTSL	→	Low when Slot 2 (cartridge slot) is selected
5 n/c	-	Not connected.
6 /RFSH	→	Refresh signal from CPU
7 /WAIT	←	OC, Tells CPU to wait. Refresh signal is not maintained
8 /INT	←	OC, Requests a interrupt to CPU (call to addr 38h)
9 /M1	→	CPU fetches first part of intruction from memory.
10 /BUSDIR	←	NC, was used to control the data direction.
11 /IORQ	→	I/O request signal. (Address=Port)
12 /MREQ	→	Memory request signal. (Address=Address)
13 /WR	→	Write signal (strobe)
14 /RD	→	Read signal (strobe)
15 /RESET	←	Reset
16 n/c	-	Not connected.
17 A0	→	Address 0
18 A1	→	Address 1
19 A2	→	Address 2
20 A3	→	Address 3
21 A4	→	Address 4
22 A5	→	Address 5
23 A6	→	Address 6
24 A7	→	Address 7
25 A8	→	Address 8
26 A9	→	Address 9
27 A10	→	Address 10
28 A11	→	Address 11
29 A12	→	Address 12
30 A13	→	Address 13
31 A14	→	Address 14
32 A15	→	Address 15
33 D0	↔	Data 0
34 D1	↔	Data 1
35 D2	↔	Data 2
36 D3	↔	Data 3
37 D4	↔	Data 4
38 D5	↔	Data 5
39 D6	↔	Data 6
40 D7	↔	Data 7
41 GND	—	Ground
42 CLOCK	→	CPU clock, 3.579 MHz
43 GND	—	Ground

BETA RELEASE

44	SW1	-	NC, Insert/remove detection for protection
45	+5V	→	+5 VDC (300mA max /slot)
46	SW2	-	NC, Insert/remove detection for protection
47	+5V	→	+5 VDC (300mA max /slot)
48	+12V	→	+12 VDC (50mA max /slot)
49	SOUNDIN	←	Sound input (-5dBm)
50	-12V	→	-12 VDC (50mA max /slot)

Note: Direction is Computer relative Peripheral.

Contributor: Joakim Ögren <qtech@mailhost.net>

Source: Mayer's SV738 X'press I/O map <<http://www.freeflight.com/fms/MSX/Portar.txt>>

Please send any comments to Joakim Ögren <qtech@mailhost.net>.

Vic 20 Memory Expansion

Available on Commodore Vic 20 computers. On the left side.

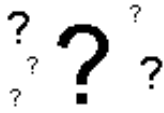
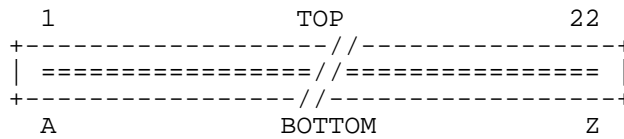

(At the Computer)

UNKNOWN CONNECTOR at the Computer.

Pin Name	Description
A	GND Ground
B	CA0 Address 0
C	CA1 Address 1
D	CA2 Address 2
E	CA3 Address 3
F	CA4 Address 4
H	CA5 Address 5
J	CA6 Address 6
K	CA7 Address 7
L	CA8 Address 8
M	CA9 Address 9
N	CA10 Address 10
P	CA11 Address 11
R	CA12 Address 12
S	CA13 Address 13
T	I/O 2 Decoded I/O block 2, starting at \$9130
U	I/O 3 Decoded I/O block 3, starting at \$9140
V	S02 Phase 2 System Clock
W	/NMI Non maskable Interrupt
X	/RESET 6502 Reset
Y	n/c Not connected
Z	GND Ground
1	GND Ground
2	CD0 Data 0
3	CD1 Data 1
4	CD2 Data 2
5	CD3 Data 3
6	CD4 Data 4
7	CD5 Data 5
8	CD6 Data 6
9	CD7 Data 7
10	/BLK 1 BLK 1 (Memory location \$2000 - \$3fff)
11	/BLK 2 BLK 2 (Memory location \$4000 - \$5fff)
12	/BLK 3 BLK 3 (Memory location \$6000 - \$7fff)
13	/BLK 5 BLK 5 (Memory location \$a000 - \$bfff)
14	RAM 1 RAM 1 (Memory location \$0400 - \$07ff)
15	RAM 2 RAM 2 (Memory location \$0800 - \$0bff)
16	RAM 3 RAM 3 (Memory location \$0c00 - \$0fff)
17	V R/W Read/Write from Vic chip (1=R, 0=W)
18	C R/W Read/Write from CPU (1=R, 0=W)
19	/IRQ 6502 Interrupt Request
20	n/c Not connected
21	+5V +5 VDC

BETA RELEASE

22 GND Ground

Contributor: Joakim Ögren <qtech@mailhost.net>

Sources: *Inside your Vic 20* <<http://ccnga.uwaterloo.ca/pub/cbm/vic-20/cartgrab.txt>> by Ward Shrake <wardshrake@aol.com>

Sources: "The Vic Revealed" by Nick Hampshire, 1982, Hayden Book Co, Inc.

Sources: "Vic20 Programmer's Reference Guide", 1992, Commodore Business Machines, Inc. and Howard W. Sams & Company, Inc.

Please send any comments to Joakim Ögren <qtech@mailhost.net>.

PRELIMINARY BETA. NOT FOR REDISTRIBUTION!

C64 Cartridge Expansion

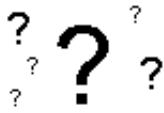

(At the computer)

44 PIN FEMALE EDGE at the computer.

Pin	Name	Description
1	GND	Ground
2	+5V	+5 Volts DC
3	+5V	+5 Volts DC
4	/IRQ	Interrupt Request
5	/CR/W	
6	DOTCLK	Dot Clock
7	I/O 1	
8	/GAME	Game
9	/EXROM	
10	I/O 2	
11	/ROML	ROM Low
12	BA	
13	/DMA	
14	CD7	Cartridge Data 7
15	CD6	Cartridge Data 7
16	CD5	Cartridge Data 7
17	CD4	Cartridge Data 7
18	CD3	Cartridge Data 7
19	CD2	Cartridge Data 7
20	CD1	Cartridge Data 7
21	CD0	Cartridge Data 7
22	GND	Ground
A	GND	Ground
B	/ROMH	ROM High
C	/RESET	Reset
D	/NMI	Non Maskable Interrupt
E	S02	
F	CA15	Cartridge Address 15
H	CA14	Cartridge Address 14
J	CA13	Cartridge Address 13
K	CA12	Cartridge Address 12
L	CA11	Cartridge Address 11
M	CA10	Cartridge Address 10
N	CA9	Cartridge Address 9
P	CA8	Cartridge Address 8
R	CA7	Cartridge Address 7
S	CA6	Cartridge Address 6
T	CA5	Cartridge Address 5
U	CA4	Cartridge Address 4
V	CA3	Cartridge Address 3
W	CA2	Cartridge Address 2
X	CA1	Cartridge Address 1
Y	CA0	Cartridge Address 0
Z	GND	Ground

Contributor: Joakim Ögren <qtech@mailhost.net>, Arwin Vosselman <0vosselman01@flnet.nl>

Source: Commodore 64 Programmer's Reference Guide

Please send any comments to Joakim Ögren <qtech@mailhost.net>.

BETA RELEASE

The Hardware Book is freely distributable but is copyrighted to Joakim Ögren. It may not be modified and re-distributed without the authors permission.

PRELIMINARY BETA. NOT FOR REDISTRIBUTION.

BETA RELEASE

C64 User Port

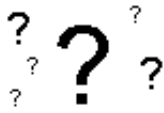

(At the computer)

24 PIN MALE EDGE (DZM 12 DREH) at the computer.

Pin	Name	Description
1	GND	Ground
2	+5V	+5 VDC (100 mA max)
3	/RESET	Reset
4	CNT1	Counter 1
5	SP1	Serial Port 1
6	CNT2	Counter 2
7	SP2	Serial Port 2
8	/PC2	
9	ATN	Serial Attention In
10	+9V AC	+9 VAC (100 mA max)
11	+9V AC	+9 VAC (100 mA max)
12	GND	Ground
A	GND	Ground
B	/FLAG2	Flag 2
C	PB0	Data 0
D	PB1	Data 1
E	PB2	Data 2
F	PB3	Data 3
H	PB4	Data 4
J	PB5	Data 5
K	PB6	Data 6
L	PB7	Data 7
M	PA2	PA2
N	GND	Ground

Contributor: Joakim Ögren <qtech@mailhost.net>, Nikolas Engström <nikolas.engstrom@pop.landskrona.se>, Arwin Vosselman <0vosselman01@flnet.nl>

Source: Commodore 64 Programmer's Reference Guide

Please send any comments to Joakim Ögren <qtech@mailhost.net>.

C128 Expansion Bus

Available at the Commodore 128.

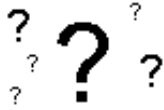

(At the computer)

44 PIN FEMALE EDGE at the computer.

Pin	Name	Description
1	GND	System Ground
2	+5V	System Vcc
3	+5V	System Vcc
4	/IRQ	Interrupt request
5	R/W	System Read/Write Signal
6	DClock	8.18MHz Video Dot Clock
7	I/O1	I/O Chip select \$de00-deff
8	/GAME	Sensed for memory map configuration
9	/EXROM	Sensed for memory map configuration
10	I/O2	I/O Chip select \$df00-dfff
11	/ROML	External ROM select \$8000-Bfff
12	BA	Bus available output
13	/DMA	Direct memory acces input
14	D7	Data bit 7
15	D6	Data bit 6
16	D5	Data bit 5
17	D4	Data bit 4
18	D3	Data bit 3
19	D2	Data bit 2
20	D1	Data bit 1
21	D0	Data bit 0
22	GND	System Ground
A	GND	System Ground
B	/ROMH	External ROM Select \$c000-ffff
C	/RESET	System Reset Signal
D	/NMI	Non-Maskable Interrupt
E	1MHz	System 1MHz clock
F	TA15	Translated address bit 15
H	TA14	Translated address bit 14
J	TA13	Translated address bit 13
K	TA12	Translated address bit 12
L	TA11	Translated address bit 11
M	TA10	Translated address bit 10
N	TA9	Translated address bit 9
P	TA8	Translated address bit 8
R	SA7	Shared address bit 7
S	SA6	Shared address bit 6
T	SA5	Shared address bit 5
U	SA4	Shared address bit 4
V	SA3	Shared address bit 3
W	SA2	Shared address bit 2
X	SA1	Shared address bit 1
Y	SA0	Shared address bit 0
Z	GND	System Ground

Contributor: Rob Gill <gillz@mpx.com.au>

BETA RELEASE

Source: Commodore 128 Programmers reference guide.

Please send any comments to Joakim Ögren <qtech@mailhost.net>.

The Hardware Book is freely distributable but is copyrighted to Joakim Ögren. It may not be modified and re-distributed without the authors permission.

PRELIMINARY BETA. NOT FOR REDISTRIBUTION.

BETA RELEASE

C16/C116/+4 Expansion Bus

Available on Commodore C16, C116 and +4 computers.

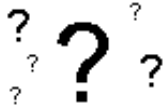

(At the Computer)

50 PIN FEMALE EDGE (2 mm pitch) at the Computer.

Pin Name	Description
1	GND Ground
2	+5V +5 VDC
3	+5V +5 VDC
4	/IRQ Interrupt
5	R/W Read/Write (1=Read, 0=Write)
6	C1HIGH External Cartridge Chip Selects C1 High
7	C2LOW External Cartridge Chip Selects C2 Low (reserved)
8	C2HIGH External Cartridge Chip Selects C2 High (reserved)
9	/CS1 Chip Select Line 1
10	/CS0 Chip Select Line 0
11	/CAS Column Address Strobe
12	MUX DRAM address multiplex control signal
13	BA Bus Available (Low=DMA)
14	D7 Data 7
15	D6 Data 6
16	D5 Data 5
17	D4 Data 4
18	D3 Data 3
19	D2 Data 2
20	D1 Data 1
21	D0 Data 0
22	AEC Address Enable Code
23	EAI External Audio In
24	PHI 2 Artificial Phi 2 signal
25	GND Ground
A	GND Ground
B	C1LOW External Cartridge Chip Selects C1 Low
C	/RESET Reset
D	/RAS Row Address Strobe
E	PHI 0 Artificial Phi 0 Signal
F	A15 Address 15
H	A14 Address 14
J	A13 Address 13
K	A12 Address 12
L	A11 Address 11
M	A10 Address 10
N	A9 Address 9
P	A8 Address 8
R	A7 Address 7
S	A6 Address 6
T	A5 Address 5
U	A4 Address 4
V	A3 Address 3
W	A2 Address 2
X	A1 Address 1
Y	A0 Address 0
Z	n/c Not connected

BETA RELEASE

AA n/c Not connected
BB n/c Not connected
CC GND Ground

PHI 2: Address valid on the rising edge, data valid on the falling edge

Contributor: Joakim Ögren <qtech@mailhost.net>, Arwin Vosselman <0vosselman01@flnet.nl>

Sources: Usenet posting in comp.sys.cbm, Pinout specs for cbm machines needed
<http://www.vuse.vanderbilt.edu/~thompsbb/cbm_conn.txt> by Lonnie McClure <lmcclore@delphi.com>
Sources: SAMS Computerfacts CC8 Commodore 16.
Sources: Article in C'T September 1986.

Please send any comments to Joakim Ögren <qtech@mailhost.net>.

The Hardware Book is freely distributable but is copyrighted to Joakim Ögren. It may not be modified and re-distributed without the authors permission.

PRELIMINARY BETA. NOT FOR REDISTRIBUTION.

+4 User Port

Available on Commodore +4 computer.

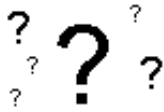

(At the Computer)

UNKNOWN CONNECTOR at the Computer.

Pin Name	Description	
1	GND	Ground
2	+5V	+5 VDC
3	/BRESET	?
4	P2/CSE	Data 2/Cassette Sense
5	P3	Data 3
6	P4	Data 4
7	P5	Data 5
8	RxC	Receive Clock
9	ATN	Attention?
10	+9V	+9 VAC
11	+9V	+9 VAC
12	GND	Ground
A	GND	Ground
B	P0	Data 0
C	RxD	Receive Data
D	RTS	Request to Send
E	DTR	Data Terminal Ready
F	P7	Data 7
G	DCD	Data Carrier Detect
H	P6	Data 6
I	CTS	Clear to Send
J	DSR	Data Set Ready
K	TxD	Transmit Data
L	GND	Ground

Contributor: Joakim Ögren <qtech@mailhost.net>, Arwin Vosselman <0vosselman01@flnet.nl>

Sources: Usenet posting in comp.sys.cbm, Pinout specs for cbm machines needed

<http://www.vuse.vanderbilt.edu/~thompsbb/cbm_conn.txt> by Lonnie McClure <lmccclure@delphi.com>

Sources: SAMS Computerfacts CC8 Commodore 16.

Please send any comments to Joakim Ögren <qtech@mailhost.net>.

CDTV Diagnostic Slot

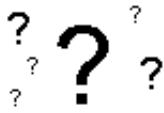

(At the computer)

80 PIN ??? CONNECTOR at the computer.

Pin Name	Description
1	GND Ground
2	GND Ground
3	VCC +5 VDC
4	VCC +5 VDC
5	/CFGOUT Configout AutoConfig signal (not connected)
6	/CFGIN Configin AutoConfig signal (grounded)
7	GND Ground
8	CCKQ 3.58 MHz CCKQ clock (C3)
9	CDAC 7.16 MHz CDAC clock (90° before system clock)
10	CCK 3.58 MHz CCK clock (C1)
11	/OVR Override (Disables /DTACK generation of Gary)
12	XRDY External Ready (Generates wait states while low).
13	/INT2 Level 2 Interrupt
14	n/c not connected
15	A5 Address Bus 5
16	/INT6 Level 6 Interrupt
17	A6 Address Bus 6
18	A4 Address Bus 4
19	GND Ground
20	A3 Address Bus 3
21	A2 Address Bus 2
22	A7 Address Bus 7
23	A1 Address Bus 1
24	A8 Address Bus 8
25	/FC0 Processor Function Code Status (bit 0)
26	A9 Address Bus 9
27	/FC1 Processor Function Code Status (bit 1)
28	A10 Address Bus 10
29	/FC2 Processor Function Code Status (bit 2)
30	A11 Address Bus 11
31	GND Ground
32	A12 Address Bus 12
33	A13 Address Bus 13
34	/IPL0 Interrupt Priority Level (bit 0)
35	A14 Address Bus 14
36	/IPL1 Interrupt Priority Level (bit 1)
37	A15 Address Bus 15
38	/IPL2 Interrupt Priority Level (bit 2)
39	A16 Address Bus 16
40	/BERR Bus Error
41	A17 Address Bus 17
42	/VPA Valid Peripheral Address (asserted by Gary)
43	GND Ground
44	E E Clock
45	/VMA Valid Memory Address (asserted by Gary)
46	A18 Address Bus 18
47	/RST Reset
48	A19 Address Bus 19
49	/HLT Halt

BETA RELEASE

50	A20	Address Bus 20
51	A22	Address Bus 22
52	A21	Address Bus 21
53	A23	Address Bus 23
54	/BR	Bus Request
55	GND	Ground
56	/BGACK	Bus Grant Acknowledge
57	D15	Data Bus 15
58	/BG	Bus Grant
59	D14	Data Bus 14
60	/DTACK	Data Transfer Acknowledge (normally asserted by Gary)
61	D13	Data Bus 13
62	R/W	Read/Write (high=read, low=write)
63	D12	Data Bus 12
64	/LDS	Lower Data Strobe
65	D11	Data Bus 11
66	/UDS	Upper Data Strobe
67	GND	Ground
68	/AS	Address Strobe
69	D0	Data Bus 0
70	D10	Data Bus 10
71	D1	Data Bus 1
72	D9	Data Bus 9
73	D2	Data Bus 2
74	D8	Data Bus 8
75	D3	Data Bus 3
76	D7	Data Bus 7
77	D4	Data Bus 4
78	D6	Data Bus 6
79	GND	Ground
80	D5	Data Bus 5

Note: Pin 7-80 is equivalent with the Amiga 500's pin 13-86 at the 86 pin Amiga 500 connector.

Contributor: Joakim Ögren <qtech@mailhost.net>

*Source: Darren Ewaniuk's CDTV Technical Information
<<http://nyquist.ee.ualberta.ca/~ewaniu/cdtv/cdtv-technical.html>>*

Please send any comments to Joakim Ögren <qtech@mailhost.net>.

CDTV Expansion Slot

```

  2  4  6  8 10 12 14 16 18 20 22 24 26 28 30
  ---
  1  3  5  7  9 11 13 15 17 19 21 24 25 27 29

```

```

  ?  ?  ?
  ?  ?  ?

```

(At the computer)

30 PIN ??? CONNECTOR at the computer.

Pin	Name	Description
1	GND	Ground
2	GND	Ground
3	VCC	+5 VDC
4	VCC	+5 VDC
5	SD1	Data Bus 1
6	SD0	Data Bus 0
7	SD3	Data Bus 3
8	SD2	Data Bus 2
9	SD5	Data Bus 5
10	SD4	Data Bus 4
11	SD7	Data Bus 7
12	SD6	Data Bus 6
13	/SDREQ	DMA Request
14	/INTX	Interrupt Request
15	/CSS	Chip Select
16	/SDACK	DMA Acknowledge
17	/IOR	I/O Read
18	/IOW	I/O Write
19	A8	Address Bus 8
20	7M	7.16 MHz System Clock
21	A6	Address Bus 6
22	A7	Address Bus 7
23	A4	Address Bus 4
24	A5	Address Bus 5
25	A2	Address Bus 2
26	A3	Address Bus 3
27	/IFRST	+5 VDC
28	A1	Address Bus 1
29	GND	Ground
30	GND	Ground

Contributor: Joakim Ögren <qtech@mailhost.net>

Source: Darren Ewaniuk's CDTV Technical Information
<<http://nyquist.ee.ualberta.ca/~ewaniu/cdtv/cdtv-technical.html>>

Please send any comments to Joakim Ögren <qtech@mailhost.net>.

PC-Engine Cartridge

Available on the PC Engine.

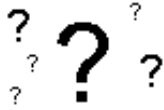

(At the PC Engine)

UNKNOWN CONNECTOR at the PC Engine.

Pin Name Description

1	?	
2	?	
3	A18?	Address 18
4	A16	Address 16
5	A15	Address 15
6	A12	Address 12
7	A7	Address 7
8	A6	Address 6
9	A5	Address 5
10	A4	Address 4
11	A3	Address 3
12	A2	Address 2
13	A1	Address 1
14	A0	Address 0
15	D0	Data 0
16	D1	Data 1
17	D2	Data 2
18	GND	Ground
19	D3	Data 3
20	D4	Data 4
21	D5	Data 5
22	D6	Data 6
23	D7	Data 7
24	/CE	Chip Select
25	A10	Address 10
26	/OE	Output Enable
27	A11	Address 11
28	A9	Address 9
29	A8	Address 8
30	A13	Address 13
31	A14	Address 14
32	A17	Address 17
33	A19?	Address 19
34	R/W	Read/Write
35	?	
36	?	
37	?	
38	+5V	+5 VDC

Pin 1 is the short pin on the left (if the card is to inserted forwards)

Pin 38 is the long pin on the right.

Contributor: Joakim Ögren <qtech@mailhost.net>

Source: Video Games FAQ (Part 3)

<<http://www.lib.ox.ac.uk/internet/news/faq/archive/games.video-games.faq.part3.html>>, Pinout by David Shadoff <daves@interlog.com>

Please send any comments to Joakim Ögren <qtech@mailhost.net>.

BETA RELEASE

SNES Cartridge

Available on the Nintendo SNES.

32	33	34	35	36	37	38	39	40	//	53	55	56	57	58	59	60	61	62
01	02	03	04	05	06	07	08	09	//	22	24	25	26	27	28	29	30	31

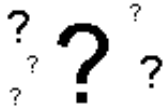

(At the SNES)

UNKNOWN CONNECTOR at the SNES.

Pin Name	Description
1	
2	
3	
4	
5	GND Ground
6	A11 Address 11
7	A10 Address 10
8	A9 Address 9
9	A8 Address 8
10	A7 Address 7
11	A6 Address 6
12	A5 Address 5
13	A4 Address 4
14	A3 Address 3
15	A2 Address 2
16	A1 Address 1
17	A0 Address 0
18	/IRQ Interrupt
19	D0 Data 0
20	D1 Data 1
21	D2 Data 2
22	D3 Data 3
23	/READ Read
24	CIC ?
25	CIC ?
26	/RAM ENABLE RAM Enable
27	VCC +5 VDC
28	
29	
30	
31	
32	
33	
34	
35	
36	GND Ground
37	A12 Address 12
38	A13 Address 13
39	A14 Address 14
40	A15 Address 15
41	A16 Address 16
42	A17 Address 17
43	A18 Address 18
44	A19 Address 19

BETA RELEASE

45	A20	Address 20
46	A21	Address 21
47	A22	Address 22
48	A23	Address 23
49	/ROM ENABLE	ROM Enable
50	D4	Data 4
51	D5	Data 5
52	D6	Data 6
53	D7	Data 7
54	/WRITE	Write
55	CIC	?
56	CIC	?
57	n/c	Not connected
58	VCC	+5 VDC
59		
60		
61		
62		

Contributor: Joakim Ögren <qtech@mailhost.net>

Source: Video Games FAQ (Part 3)

<<http://www.lib.ox.ac.uk/internet/news/faq/archive/games.video-games.faq.part3.html>>, Pinout by Thomas Rolfes <rolfes@uni-muenster.de>

Please send any comments to Joakim Ögren <qtech@mailhost.net>

TG-16 Cartridge

Available on the TG-16.

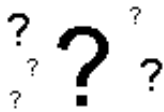

(At the TG-16)

UNKNOWN CONNECTOR at the TG-16.

Pin Name Description

1	?	
2	?	
3	A18?	Address 18
4	A16	Address 16
5	A15	Address 15
6	A12	Address 12
7	A7	Address 7
8	A6	Address 6
9	A5	Address 5
10	A4	Address 4
11	A3	Address 3
12	A2	Address 2
13	A1	Address 1
14	A0	Address 0
15	D7	Data 7
16	D6	Data 6
17	D5	Data 5
18	GND	Ground
19	D4	Data 4
20	D3	Data 3
21	D2	Data 2
22	D1	Data 1
23	D0	Data 0
24	/CE	Chip Select
25	A10	Address 10
26	/OE	Output Enable
27	A11	Address 11
28	A9	Address 9
29	A8	Address 8
30	A13	Address 13
31	A14	Address 14
32	A17	Address 17
33	A19?	Address 19
34	R/W	Read/Write
35	?	
36	?	
37	?	
38	+5V	+5 VDC

Pin 1 is the short pin on the left (if the card is to inserted forwards)

Pin 38 is the long pin on the right.

Contributor: Joakim Ögren <qtech@mailhost.net>

Source: Video Games FAQ (Part 3)

<<http://www.lib.ox.ac.uk/internet/news/faq/archive/games.video-games.faq.part3.html>>, Pinout by David Shadoff <daves@interlog.com>

Please send any comments to Joakim Ögren <qtech@mailhost.net>.

BETA RELEASE

ZX Spectrum AY-3-8912

Can be found at Sinclair ZX Spectrum's, I think

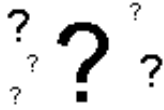

(At the computer)

UNKNOWN CONNECTOR at the computer.

Pin Name	Description
1	SOUND C Sound C (Can be tied together with A & B)
2	PORT ?
3	VCC +5 VDC
4	SOUND B Sound B (Can be tied together with A & C)
5	SOUND A Sound A (Can be tied together with B & C)
6	GND Ground
7	PORT ?
8	PORT ?
9	PORT ?
10	PORT ?
11	PORT ?
12	PORT ?
13	PORT ?
14	CLOCK ?
15	CLOCK ?
16	RESET Reset
17	A8 Address 8?
18	BDIR ?
19	BC2 ?
20	BC1 ?
21	D7 Data 7
22	D6 Data 6
23	D5 Data 5
24	D4 Data 4
25	D3 Data 3
26	D2 Data 2
27	D1 Data 1
28	D0 Data 0

Contributor: Joakim Ögren <qtech@mailhost.net>

Source: ZX Spectrum FAQ <<http://users.ox.ac.uk/~uzdm0006/Damien/speccy/pinouts.html>>

Please send any comments to Joakim Ögren <qtech@mailhost.net>.

ZX Spectrum ULA

Can be found at Sinclair ZX Spectrum's, I think

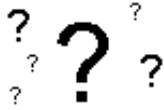

(At the computer)

UNKNOWN CONNECTOR at the computer.

Pin Name	Description
1	
2	/WR Write
3	/RD Read
4	/WE Write Enable
5	A0 Address 0
6	A1 Address 1
7	A2 Address 2
8	A3 Address 3
9	A4 Address 4
10	A5 Address 5
11	A6 Address 6
12	/INT Interrupt
13	+5V +5 VDC (One of the +5V is decoupled through a RC-low-pass.)
14	+5V +5 VDC (One of the +5V is decoupled through a RC-low-pass.)
15	U Color-difference signals.
16	V Color-difference signals.
17	/Y Inverted Video+Sync.
18	D0 Data 0
19	T0 Keyboard Data 0
20	T1 Keyboard Data 1
21	D1 Data 1
22	D2 Data 2
23	T2 Keyboard Data 2
24	T3 Keyboard Data 3
25	D3 Data 3
26	T4 Keyboard Data 4
27	D4 Data 4
28	SOUND Analog-I/O-line for beep, save and load.
29	D5 Data 5
30	D6 Data 6
31	D7 Data 7
32	CLOCK The clock-source to the CPU including the inhibited T-states.
33	/IO-ULA (A0(CPU) OR /IORQ) for the I/O-port FEh
34	/ROM CS ROM ChipSelect
35	/RAS Row Address Strobe
36	A14 Address 14
37	A15 Address 15
38	/MREQ ???
39	Q The 14 MHz crystal. Other side grounded through capacitor.
40	

Contributor: Joakim Ögren <qtech@mailhost.net>

Source: ZX Spectrum FAQ <<http://users.ox.ac.uk/~uzdm0006/Damien/speccy/pinouts.html>>

Please send any comments to Joakim Ögren <qtech@mailhost.net>.

Spectravideo SVI318/328 Expansion Bus

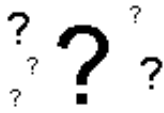

(At the computer)

50 PIN MALE EDGE the computer.

Pin	Pin Name	Dir	Description
1	+5v	→	Power, 300mA
2	/CNTRL2	←	Game adaptor control signal
3	+12v	→	Power, 100mA
4	-12v	→	Power, 50mA
5	/CNTRL1	←	Game adaptor control signal
6	/WAIT	←	Z80 WAIT
7	/RST	←	Z80 RST
8	CPU CLK	→	Buffered 3.58MHz system clock
9	A15	→	Buffered Address bus
10	A14	→	"
11	A13	→	"
12	A12	→	"
13	A11	→	"
14	A10	→	"
15	A9	→	"
16	A8	→	"
17	A7	→	"
18	A6	→	"
19	A5	→	"
20	A4	→	"
21	A3	→	"
22	A2	→	"
23	A1	→	"
24	A0	→	"
25	/RFSH	→	RAM expansion refresh
26	/EXCSR	←	Video-CPU write select
27	/M1	→	Z80 M1
28	/EXCSW	←	CPU-Video write select
29	/WR	→	Z80 WR
30	/MREQ	→	Z80 MREQ
31	/IORQ	→	Z80 IORQ
32	/RD	→	Z80 RD
33	D0	I/O	Buffered Data Bus
34	D1	I/O	"
35	D2	I/O	"
36	D3	I/O	"
37	D4	I/O	"
38	D5	I/O	"
39	D6	I/O	"
40	D7	I/O	"
41	CSOUND	←	Audio input signal
42	/INT	←	Z80 INT
43	/RAMDIS	←	Disable user RAM
44	/ROMDIS	←	Disable basic ROM
45	/BK32	→	Enable bank 32 Memory (8000-ffff)
46	/BK31	→	Enable bank 31 Memory (0000-7FFF)
47	/BK22	→	Enable bank 22 Memory (8000-FFFF)
48	/BK21	→	Enable bank 21 Memory (0000-7FFF)
49	GND	-	System Ground

BETA RELEASE

50 GND - System Ground

Contributer: Rob Gill <gillz@mpx.com.au>

Source: SVI 328 Mk II User Manual

Please send any comments to Joakim Ögren <qtech@mailhost.net>.

The Hardware Book is freely distributable but is copyrighted to Joakim Ögren. It may not be modified and re-distributed without the authors permission.

PRELIMINARY BETA. NOT FOR REDISTRIBUTION.

BETA RELEASE

Spectravideo SVI318/328 Game Cartridge

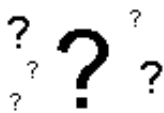

(At the computer)

30 PIN FEMALE EDGE at the computer.

Pin Name

1	+5v
2	+5v
3	A7
4	A12
5	A6
6	A13
7	A5
8	A8
9	A4
10	A9
11	A3
12	A11
13	A10
14	A2
15	A0
16	A1
17	D0
18	D7
19	D1
20	D6
21	D2
22	D5
23	D3
24	D4
25	CCS3
26	CCS4
27	CCS1
28	CCS2
29	GND
30	GND

Contributer: Rob Gill <gillz@mpx.com.au>

Source: SVI 328 mk II user manual

Please send any comments to Joakim Ögren <qtech@mailhost.net>.

MIDI Out

MIDI=Musical Instrument Digital Interface.



(At the peripheral)



(At the cable)

5 PIN DIN 180° (DIN41524) FEMALE at the peripheral.

5 PIN DIN 180° (DIN41524) MALE at the cable.

Pin Name	Description
1	n/c Not connected
2	GND Ground
3	n/c Not connected
4	CSINK Current Sink
5	CSRC Current Source

Contributor: Joakim Ögren <qtech@mailhost.net>

Source: ?

Please send any comments to Joakim Ögren <qtech@mailhost.net>.

PRELIMINARY BETA. NOT FOR REDISTRIBUTION.

MIDI In

MIDI=Musical Instrument Digital Interface.



(At the peripheral)



(At the cable)

5 PIN DIN 180° (DIN41524) FEMALE at the peripheral.

5 PIN DIN 180° (DIN41524) MALE at the cable.

Pin Name	Description
1	n/c Not connected
2	n/c Not connected
3	n/c Not connected
4	CSRC Current Source
5	CSINK Current Sink

Contributor: Joakim Ögren <qtech@mailhost.net>

Source: ?

Please send any comments to Joakim Ögren <qtech@mailhost.net>.

PRELIMINARY BETA. NOT FOR REDISTRIBUTION.

Minuteman UPS

Is the directions right???

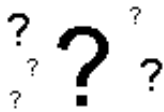

(At the UPS)

9 PIN D-SUB ??? at the UPS.

Pin Description

- 1 Unused
- 2 Battery power
- 3 Unused
- 4 Common (same as 7)
- 5 Low battery
- 6 RS-232 level shutdown
- 7 Common (same as 4)
- 8 Ground level shutdown (A500 and above, reserved on >A500)
- 9 Reserved

Pins 2 and 5 are connected to Common when they are true.

On pin 6, an rs-232 high level (>9V) will shutdown, when running off the battery.

On pin 8, shorting to ground will shutdown.

Contributor: Joakim Ögren <qtech@mailhost.net>

Source: Tommy's pinout Collection <<http://csgrad.cs.vt.edu/~tjohnson/pinouts>> by Tommy Johnson <tjohnson@csgrad.cs.vt.edu>

Please send any comments to Joakim Ögren <qtech@mailhost.net>.

C64 Power Supply

Available at the Commodore 64.

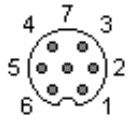

(At the computer)

7 PIN DIN 'O' FEMALE at the computer.

Pin Name

- 1 Shield Ground
- 2 Shield Ground
- 3 Shield Ground
- 4 nc
- 5 +5v In
- 6 9Vac in
- 7 9Vac in

Contributor: Rob Gill <gillz@mpx.com.au>

Source: Commodore 64 Programmers Reference Guide

Please send any comments to Joakim Ögren <qtech@mailhost.net>

PRELIMINARY BETA. NOT FOR REDISTRIBUTION.

Amstrad CPC6128 Stereo

**NOT
DRAWN
YET...**



(At the computer)



(At the cable)

3.5 mm STEREO TELEPHONE FEMALE at the computer.

3.5 mm STEREO TELEPHONE MALE at the cable.

Pin	Description
L	Left Channel
R	Right Channel
GND	Ground

Contributor: Joakim Ögren <qtech@mailhost.net>, Agnello Guarracino <aggy@ooh.diron.co.uk>

Source: Amstrad CPC6128 User Instructions Manual

Please send any comments to Joakim Ögren <qtech@mailhost.net>.

Chapter 2

Connector Top 10 Menu

This is not exactly 10 entries, but the most common connectors. If you don't find what you're searching for here, look at the full list.

What does the the information that is listed for each connector mean? See the tutorial.

Buses:

- ISA - (Technical)
- EISA - (Technical)
- PCI - (Technical)
- VESA LocalBus (VLB) - (Technical)

In/Out:

- Serial (PC 9)
- Serial (PC 25)
- Parallel (PC)
- Centronics Printer

Video:

- VGA (15)
- VGA (9)
- Amiga Video

Joystick/Mouse:

- Gameport (PC)
- Mouse/Joy (Amiga)

Diskdrive:

- Internal Diskdrive

Keyboard:

- Keyboard (5 PC)
- Keyboard (6 PC)

Data storage interfaces:

- SCSI Internal

Chapter 2: Connector Top 10 Menu

- SCSI External Centronics 50
- SCSI External (Amiga/Mac)
- IDE Internal
- ATA Internal

Memories:

- SIMM 30-pin
- SIMM 72-pin

Home audio/video:

- SCART

Networking:

- Ethernet 10Base-T

Last updated 1997-08-31.

(C) Joakim Ögren <qtech@mailhost.net> 1996, 1997

PRELIMINARY BETA. NOT FOR REDISTRIBUTION.

Chapter 3

Cable Menu

What does the the information that is listed for each connector mean? See the tutorial.

Nullmodem:

- Nullmodem (9p to 9p)
- Nullmodem (9p to 25p)
- Nullmodem (25p to 25p)
- Mac to C64 Nullmodem

Modem:

- Modem (9p to 25p)
- Modem (25p to 25p)
- Two-Wire Modem (9p to 25p)
- Two-Wire Modem (25p to 25p)
- Macintosh Modem (With DTR)
- Macintosh Modem (Without DTR)
- RocketPort Serial (25) Cable **NEW**

Printer:

- Centronics Printer cable **UPDATED**
- Serial Printer (9p to 25p)
- Serial Printer (25p to 25p)
- C64 Centronics Printer

Parallel:

- LapLink/InterLink Parallel **UPDATED**
- ParNet Parallel
- 64NET
- GEOCable

Misc Serial:

- Cisco Console (9p) **NEW**
- Cisco Console (25p) **NEW**
- Conrad Electronics MM3610D (9p) **NEW**
- Conrad Electronics MM3610D (25p) **NEW**
- Mac to HP48

Loopback plugs:

- Parallel Port Loopback (Norton)
- Parallel Port Loopback (CheckIt)
- Serial Port Loopback (9p Norton)
- Serial Port Loopback (25p Norton)
- Serial Port Loopback (9p CheckIt)
- Serial Port Loopback (25p CheckIt)

Data storage:

- Floppy cable
- IDE cable
- SCSI cable (Amiga/Mac)
- SCSI Cable (D-Sub to Hi D-Sub)
- ST506/412 cable
- ESDI cable
- Paravision SX1 to IDE **NEW**

TV/Video/Monitor:

- Video to TV SCART cable
- Amiga to SCART cable
- 9 to 15 pin VGA cable
- Amiga to C1084 Monitor cable
- C128/C64C to CBM 1902A Monitor cable
- C128/C64C to SCART (S-Video) cable
- NeoGeo to SCART cable **UPDATED**

Networking:

- Ethernet 10/100Base-T Crossover cable **UPDATED**
- Ethernet 10/100Base-T Straight Thru cable **UPDATED**
- Ethernet 100Base-T4 Crossover cable **NEW**

Misc:

- ParaLoad cable
- X1541 cable
- MIDI cable
- Misc unsupported cables

Last updated 1997-08-31.

(C) Joakim Ögren <qtech@mailhost.net> 1996, 1997

Short tutorial

Heading

First at each page there a short heading describing the cable.

Pictures of the connectors

After that there is at each page there is one or more pictures of the connectors. Sometimes there is some question marks only. This means that I don't know what kind of connector it is or how it looks.

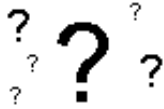

(To the computer)

There may be some pictures I haven't drawn yet. I illustrate this with the following advanced picture:

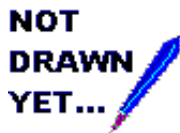

(To the computer)

Normally are one or more pictures. **These are seen from the front, and NOT the soldside. Holes (female connectors usually) are darkened.** Look at the example below. The first is a female connector and the send a male. The texts insde parentheses will tell you at which kind of the device it will look like that.

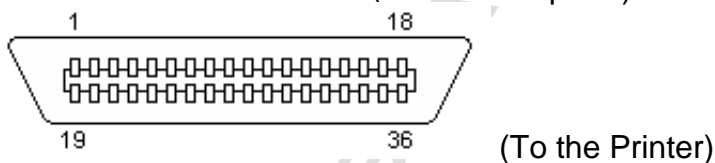
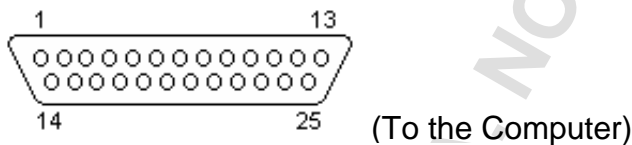

Texts describing the connectors

Below the pictures there is texts that describes the connectors. Including the name of the physical connector.

25 PIN D-SUB MALE to the Computer

36 PIN CENTRONICS MALE to the Printer.

Pin table

The pin table is perhaps the information you're looking for. Should be simple to read. Contains mostly the following three columns; Name, Pin 1, Pin 2. Sometimes when not the same pin is connected to each side there is another column describing the name at connector 2.

	25-DSub	36-Cen
Strobe	1	1
Data Bit 0	2	2
Data Bit 1	3	3
Data Bit 2	4	4

Data Bit 3	5	5
Data Bit 4	6	6
Data Bit 5	7	7
Data Bit 6	8	8
Data Bit 7	9	9
...

Contributor & Source

All persons that helped me or sent me information about the connector will be listed here. The source of the information is perhaps a book or another site. I must admit that I'm bad at writing the source, but I'll try to fill in these in the future.

Contributor: Joakim Ögren <qtech@mailhost.net>

Source: Amiga 4000 User's Guide from Commodore

Nullmodem (9-9) Cable

Use this cable between two DTE devices (for instance two computers).

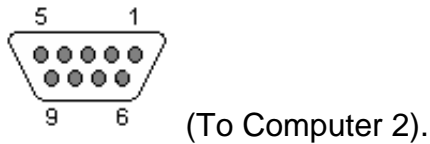
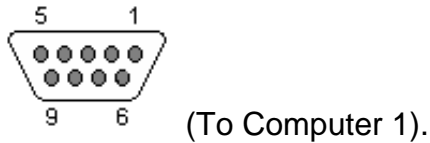

9 PIN D-SUB FEMALE to Computer 1.

9 PIN D-SUB FEMALE to Computer 2.

	D-Sub 1	D-Sub 2	
Receive Data	2	3	Transmit Data
Transmit Data	3	2	Receive Data
Data Terminal Ready	4	6+1	Data Set Ready + Carrier Detect
System Ground	5	5	System Ground
Data Set Ready + Carrier Detect	6+1	4	Data Terminal Ready
Request to Send	7	8	Clear to Send
Clear to Send	8	7	Request to Send

Note: DSR & CD are jumpered to fool the programs to think that their online.

Contributor: Joakim Ögren <qtech@mailhost.net>, Drew Sullivan <drew@ss.org>, Niklas Edmundsson <nikke@ing.umu.se>

Source: ?

Please send any comments to Joakim Ögren <qtech@mailhost.net>.

Nullmodem (9-25) Cable

Use this cable between two DTE devices (for instance two computers).

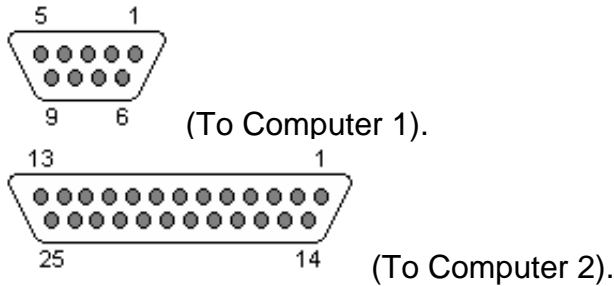

9 PIN D-SUB FEMALE to Computer 1.
25 PIN D-SUB FEMALE to Computer 2.

	D-Sub 9	D-Sub 25	
Receive Data	2	2	Transmit Data
Transmit Data	3	3	Receive Data
Data Terminal Ready	4	6+8	Data Set Ready + Carrier Detect
System Ground	5	7	System Ground
Data Set Ready + Carrier Detect	6+1	20	Data Terminal Ready
Request to Send	7	5	Clear to Send
Clear to Send	8	4	Request to Send

Note: DSR & CD are jumpered to fool the programs to think that their online.

Contributor: Joakim Ögren <qtech@mailhost.net>, Drew Sullivan <drew@ss.org>, Niklas Edmundsson <nikke@ing.umu.se>

Source: ?

Please send any comments to Joakim Ögren <qtech@mailhost.net>.

Nullmodem (25-25) Cable

Use this cable between two DTE devices (for instance two computers).

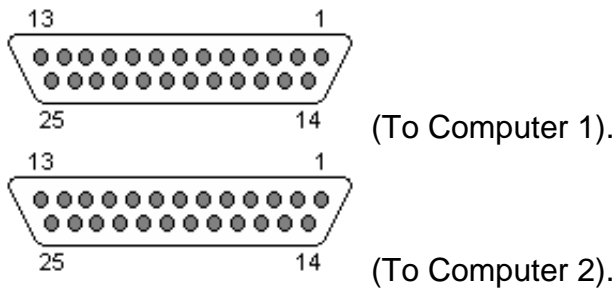

25 PIN D-SUB FEMALE to Computer 1.

25 PIN D-SUB FEMALE to Computer 2.

	D-Sub 1	D-Sub 2	
Receive Data	3	2	Transmit Data
Transmit Data	2	3	Receive Data
Data Terminal Ready	20	6+8	Data Set Ready + Carrier Detect
System Ground	7	7	System Ground
Data Set Ready + Carrier Detect	6+8	20	Data Terminal Ready
Request to Send	4	5	Clear to Send
Clear to Send	5	4	Request to Send

Note: DSR & CD are jumpered to fool the programs to think that their online.

Contributor: Joakim Ögren <qtech@mailhost.net>, Drew Sullivan <drew@ss.org>, Niklas Edmundsson <nikke@ing.umu.se>

Source: ?

Please send any comments to Joakim Ögren <qtech@mailhost.net>.

Mac to C64 Nullmodem Cable

The RS-232 standard on the C64 is a little bit strange. It uses inverted TTL level for the signals. The RS-422 ports on the Macintosh has both an inverted and non-inverted input. By using the inverted instead of non-inverted the inverted C64 level is back to normal.

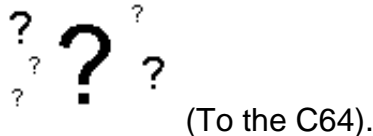
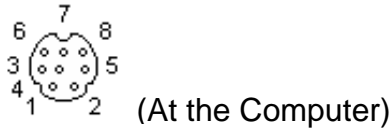

8 PIN MINI-DIN MALE to the Macintosh.
DZM 12 DREH to the C64 UserPort.

	Mac	C64	
GND+RXD-	4+5	1+12+A+N	GND
RXD+	8	M	TXD (PA2)
TXD+	6	B+C	RXD (FLAG2+PB0)
		D+E	RTS+DTR (PB1+PB2)

Contributor: Joakim Ögren <qtech@mailhost.net>, Pierre Olivier <olipie@aei.ca>

Source: Usenet posting in comp.sys.cbm, A very simple C64 to Macintosh serial cable
<http://stekt oulu.fi/~jopi/electronics/cbm/C64_to_mac> by Chris Baird <c8923075@cs.newcastle.edu.au>

Please send any comments to Joakim Ögren <qtech@mailhost.net>.

Modem (9-25) Cable

This cable should be used for DTE to DCE (for instance computer to modem) connections with hardware handshaking.

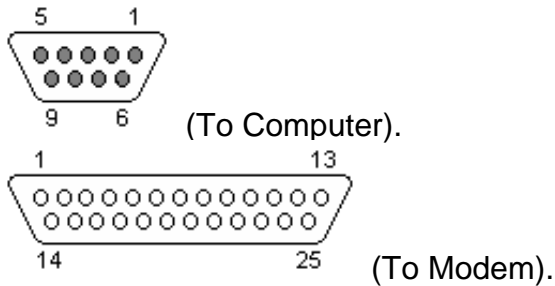

9 PIN D-SUB FEMALE to the Computer
25 PIN D-SUB MALE to the Modem

	Female	Male	Dir
Shield		1	
Transmit Data	3	2	→
Receive Data	2	3	←
Request to Send	7	4	→
Clear to Send	8	5	→
Data Set Ready	6	6	↔
System Ground	5	7	
Carrier Detect	1	8	←
Data Terminal Ready	4	20	→
Ring Indicator	9	22	←

Contributor: Joakim Ögren <qtech@mailhost.net>, Søren Graversen <graver@post1.tele.dk>

Source: ?

Please send any comments to Joakim Ögren <qtech@mailhost.net>.

Modem (25-25) Cable

This cable should be used for DTE to DCE (for instance computer to modem) connections with hardware handshaking.

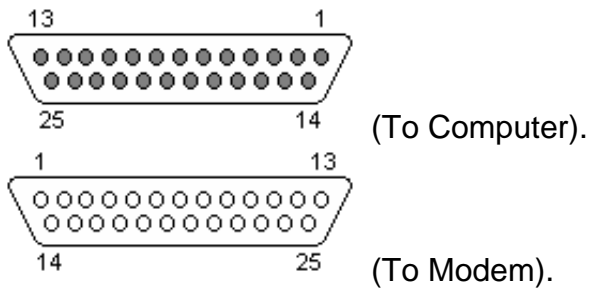

25 PIN D-SUB FEMALE to the Computer
25 PIN D-SUB MALE to the Modem

	Female	Male	Dir
Shield Ground	1	1	
Transmit Data	2	2	→
Receive Data	3	3	←
Request to Send	4	4	→
Clear to Send	5	5	←
Data Set Ready	6	6	←
System Ground	7	7	
Carrier Detect	8	8	←
Data Terminal Ready	20	20	→
Ring Indicator	22	22	←

Contributor: Joakim Ögren <qtech@mailhost.net>, Søren Graversen <graver@post1.tele.dk>

Source: ?

Please send any comments to Joakim Ögren <qtech@mailhost.net>.

Two-Wire Modem (9-25) Cable

This cable should be used for DTE to DCE (for instance computer to modem) connections without hardware handshaking.

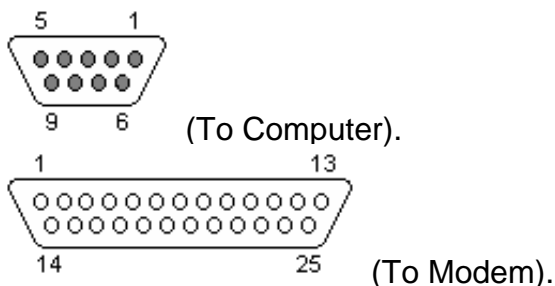

9 PIN D-SUB FEMALE to the Computer
25 PIN D-SUB MALE to the Modem

	Female	Male	Dir
Shield Ground		1	
Transmit Data	3	2	→
Receive Data	2	3	←
System Ground	5	7	
Jumper these:			
Request to Send	7		→
Clear to Send	8		←
Data Set Ready	6		←
Carrier Detect	1		←
Data Terminal Ready	4		←
Request to Send		4	→
Clear to Send		5	←
Data Set Ready		6	←
Carrier Detect		8	←
Data Terminal Ready		20	←

Contributor: Joakim Ögren <qtech@mailhost.net>

Source: ?

Please send any comments to Joakim Ögren <qtech@mailhost.net>.

Two-Wire Modem (25-25) Cable

This cable should be used for DTE to DCE (for instance computer to modem) connections without hardware handshaking.

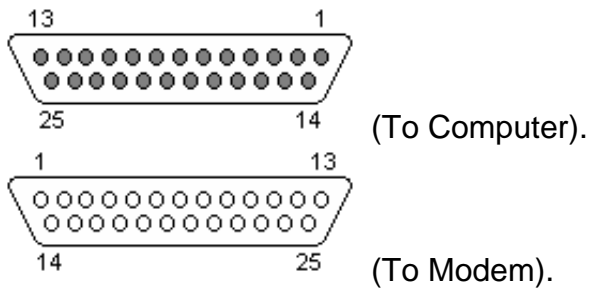

25 PIN D-SUB FEMALE to the Computer
25 PIN D-SUB MALE to the Modem

	Female	Male	Dir
Shield Ground	1	1	
Transmit Data	2	2	→
Receive Data	3	3	←
System Ground	7	7	
Jumper these:			
Request to Send	4		→
Clear to Send	5		←
Data Set Ready	6		←
Carrier Detect	8		←
Data Terminal Ready	20		→
Request to Send		4	→
Clear to Send		5	←
Data Set Ready		6	←
Carrier Detect		8	←
Data Terminal Ready		20	→

Contributor: Joakim Ögren <qtech@mailhost.net>

Source: ?

Please send any comments to Joakim Ögren <qtech@mailhost.net>.

Macintosh Modem (With DTR) Cable

This cable should be used for DTE to DCE (for instance computer to modem) connections with DTR.

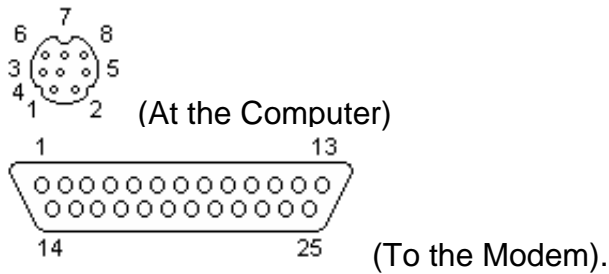

8 PIN MINI-DIN MALE to the Computer.
25 PIN D-SUB MALE to the Modem

	Mac	Dir	Modem	
HSKo	1	→	4+20	RTS+DTR
HSKi	2	←	5	CTS
TxD-	3	→	2	TxD
RxD-	5	←	3	RxD
GND+RxD+	4+8	-	7	GND
GPI	5	←	8	DCD

Contributor: Joakim Ögren <qtech@mailhost.net>, Pierre Olivier <olipie@aei.ca>

Source: comp.sys.mac.comm FAQ Part 1

<<http://www.cis.ohio-state.edu/hypertext/faq/usenet/macintosh/comm-faq/part1/faq.html>>

Please send any comments to Joakim Ögren <qtech@mailhost.net>.

Macintosh Modem (Without DTR) Cable

This cable should be used for DTE to DCE (for instance computer to modem) connections without DTR.

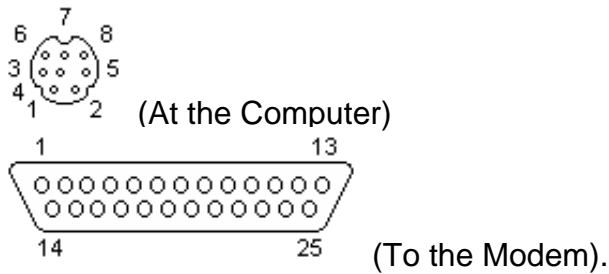

8 PIN MINI-DIN MALE to the Computer.
25 PIN D-SUB MALE to the Modem

	Mac	Dir	Modem	
HSKo	1	→	4	RTS
HSKi	2	←	5	CTS
TxD-	3	→	2	TxD
RxD-	5	←	3	RxD
GND+RxD+	4+8	-	7	GND
			6+20	DSR+DTR

Contributor: Joakim Ögren <qtech@mailhost.net>, Pierre Olivier <olipie@aei.ca>

Source: comp.sys.mac.comm FAQ Part 1

<<http://www.cis.ohio-state.edu/hypertext/faq/usenet/macintosh/comm-faq/part1/faq.html>>

Please send any comments to Joakim Ögren <qtech@mailhost.net>.

RocketPort Serial (25) Cable

Use this cable to connect a RocketPort serialport card to a modem.

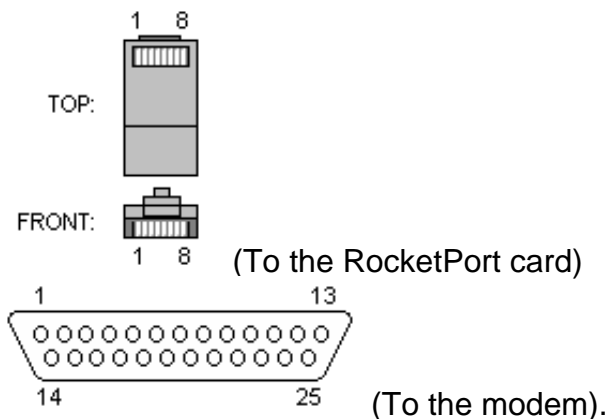

RJ45 MALE CONNECTOR to the RocketPort card.
25 PIN D-SUB MALE to the modem

Description	RJ45	D-Sub	Dir
Request To Send	1	4	↓
Data Terminal Ready	2	20	↓
Ground	3	7	↓
Transceive Data	3	2	↓
Receive Data	6	3	↑
Data Carrier Detect	6	8	↑
Data Set Ready	7	6	↑
Clear To Send	8	5	↑

Contributor: Joakim Ögren <qtech@mailhost.net>, Karl Asha <karl@blackdown.com>

Source: ?

Please send any comments to Joakim Ögren <qtech@mailhost.net>.

Printer Cable

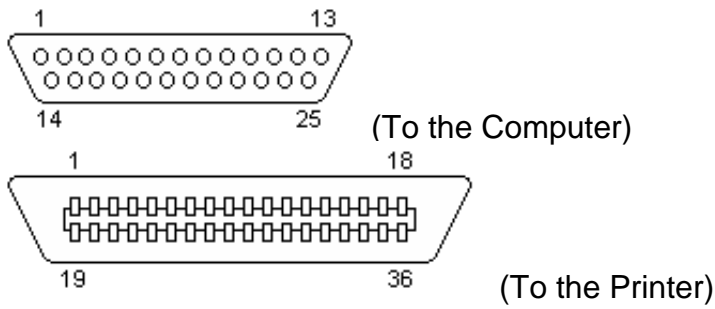

25 PIN D-SUB MALE to the Computer
 36 PIN CENTRONICS MALE to the Printer.

	25-DSub	36-Cen
Strobe	1	1
Data Bit 0	2	2
Data Bit 1	3	3
Data Bit 2	4	4
Data Bit 3	5	5
Data Bit 4	6	6
Data Bit 5	7	7
Data Bit 6	8	8
Data Bit 7	9	9
Acknowledge	10	10
Busy	11	11
Paper Out	12	12
Select	13	13
Autofeed	14	14
Error	15	32
Reset	16	31
Select	17	36
Signal Ground	18	33
Signal Ground	19	19,20
Signal Ground	20	21,22
Signal Ground	21	23,24
Signal Ground	22	25,26
Signal Ground	23	27
Signal Ground	24	28,29
Signal Ground	25	30,16
Shield	Shield	Shield+17

Contributor: Joakim Ögren <qtech@mailhost.net>, Petr Krc <magneton@mail.firstnet.cz>

Source: ?

Please send any comments to Joakim Ögren <qtech@mailhost.net>.

Serial Printer (9-25) Cable

Use this cable between two a computer (DTE) and a printer (DTE) devices.

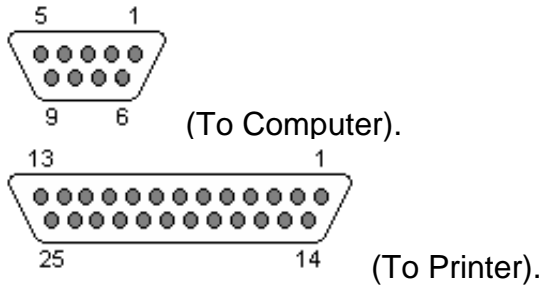

9 PIN D-SUB FEMALE to Computer.
25 PIN D-SUB FEMALE to Printer.

	D-Sub 1	D-Sub 2	
Receive Data	3	3	Transmit Data
Transmit Data	2	2	Receive Data
Clear To Send + Data Set Ready	8 + 6	20	Data Terminal Ready
Carrier Detect + Data Terminal Ready	1 + 4		
Ground	5	7	Ground

Contributor: Joakim Ögren <qtech@mailhost.net>

Source: ?

Please send any comments to Joakim Ögren <qtech@mailhost.net>.

Serial Printer (25-25) Cable

Use this cable between two a computer (DTE) and a printer (DTE) devices.

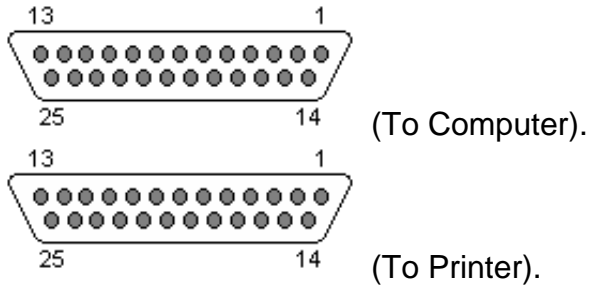

25 PIN D-SUB FEMALE to Computer.

25 PIN D-SUB FEMALE to Printer.

	D-Sub 1	D-Sub 2	
Receive Data	2	3	Transmit Data
Transmit Data	3	2	Receive Data
Clear To Send + Data Set Ready	5 + 6	20	Data Terminal Ready
Carrier Detect + Data Terminal Ready	8 + 20		
Ground	7	7	Ground

Contributor: Joakim Ögren <qtech@mailhost.net>

Source: ?

Please send any comments to Joakim Ögren <qtech@mailhost.net>.

C64 Centronics Printer Cable

Requires a cartridge with Centronics support (TFCIII or ActionReplay.)

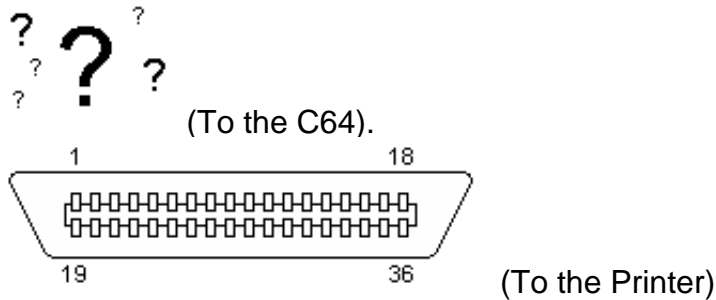

DZM 12 DREH to the C64 UserPort.
36 PIN CENTRONICS MALE to the Printer.

	C64	Dir	Printer	
GND	1,12,A,N	↓	19-30,33	Ground
FLAG2	B	↑	10	Acknowledge
PB0	C	→	2	Data 0
PB1	D	→	3	Data 1
PB2	E	→	4	Data 2
PB3	F	→	5	Data 3
PB4	H	→	6	Data 4
PB5	J	→	7	Data 5
PB6	K	→	8	Data 6
PB7	L	→	9	Data 7
PA2	M	→	1	Strobe
GND	3	→	31	Initialize Printer

Contributor: Joakim Ögren <qtech@mailhost.net>

Source: CBM Memorial Page Pinouts <http://www.vuse.vanderbilt.edu/~thompsbb/cbm_conn.txt>, pinout by Roy Kannady <kannady@pogo.den.mmc.com>

Please send any comments to Joakim Ögren <qtech@mailhost.net>.

LapLink/InterLink Parallel Cable

Will work with:

- LapLink from Travelling Software
- MS-DOS v6.0 InterLink from Microsoft
- Windows 95 Direct Cable connection from Microsoft
- Norton Commander v4.0 & v5.0 from Symantec

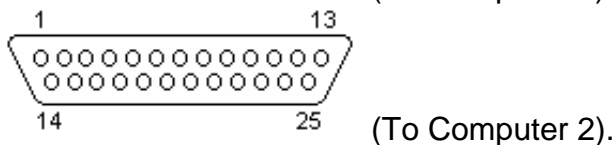
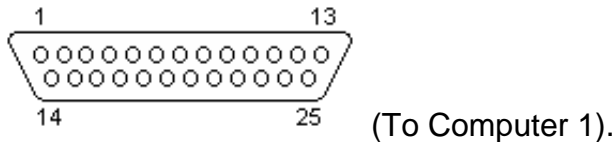

25 PIN D-SUB MALE to Computer 1.
25 PIN D-SUB MALE to Computer 2.

Name	Pin	Pin	Pin Name
Data Bit 0	2	15	Error
Data Bit 1	3	13	Select
Data Bit 2	4	12	Paper Out
Data Bit 3	5	10	Acknowledge
Data Bit 4	6	11	Busy
Acknowledge	10	5	Data Bit 3
Busy	11	6	Data Bit 4
Paper Out	12	4	Data Bit 2
Select	13	3	Data Bit 1
Error	15	2	Data Bit 0
Reset	16	16	Reset
Select	17	17	Select
Signal Ground	25	25	Signal Ground

Contributor: Joakim Ögren <qtech@mailhost.net>

Source: ?

Please send any comments to Joakim Ögren <qtech@mailhost.net>.

ParNet Parallel Cable

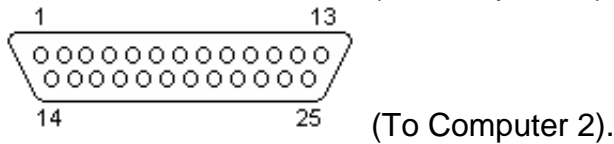
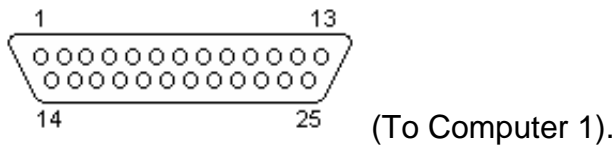

25 PIN D-SUB MALE to Computer 1.

25 PIN D-SUB MALE to Computer 2.

Name	Pin	Pin	Name
Data Bit 0	2	2	Data Bit 0
Data Bit 1	3	3	Data Bit 1
Data Bit 2	4	4	Data Bit 2
Data Bit 3	5	5	Data Bit 3
Data Bit 4	6	6	Data Bit 4
Data Bit 5	7	7	Data Bit 5
Data Bit 6	8	8	Data Bit 6
Data Bit 7	9	9	Data Bit 7
Acknowledge + Select	10+13	10+13	Acknowledge + Select
Busy	11	11	Busy
Paper Out	12	12	Paper Out
Signal Ground	17-25	17-25	Signal Ground

Contributor: Joakim Ögren <qtech@mailhost.net>

Source: ?

Please send any comments to Joakim Ögren <qtech@mailhost.net>.

64NET Cable

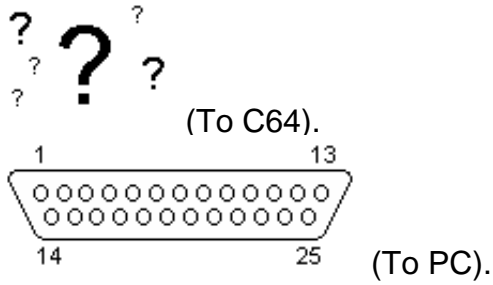

DZM 12 DREH to the C64 UserPort.
25 PIN D-SUB MALE to the PC

	C64	Dir	PC	
GND	A	—	25	GND
PB0	C	→	10	/ACK
PB1	D	→	11	BUSY
PB2	E	→	12	PE
PB3	F	←	5	D3
PB4	H	←	6	D4
PB5	J	←	7	D5
PB6	K	←	8	D6
PB7	L	←	9	D7

Contributor: Joakim Ögren <qtech@mailhost.net>

Source: 64NET v1.82.58 documentation by Paul Gardner-Stephen <gardners@ist.flinders.edu.au>

Please send any comments to Joakim Ögren <qtech@mailhost.net>.

GEOCable Cable

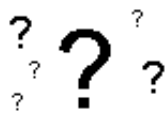

(To the C64).

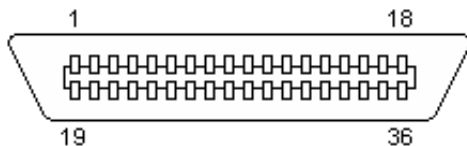

(To the Printer)

DZM 12 DREH to the C64 UserPort.
36 PIN CENTRONICS MALE at the Printer.

C64 Printer

Ground	A	33	Ground
Flag 2	B	11	Busy
PB0	C	2	Data 1
PB1	D	3	Data 2
PB2	E	4	Data 3
PB3	F	5	Data 4
PB4	H	6	Data 5
PB5	J	7	Data 6
PB6	K	8	Data 7
PB7	L	9	Data 8
PA2	M	1	Strobe
Ground	N	16	Ground

Contributor: Joakim Ögren <qtech@mailhost.net>

Source: comp.sys.cbm General FAQ v3.1 Part 7

<<http://www.lib.ox.ac.uk/internet/news/faq/archive/cbm-main-faq.3.1.p7.html>>

Please send any comments to Joakim Ögren <qtech@mailhost.net>.

Cisco Console (9) Cable

Use this cable to configure a Cisco router thru the Console port at the router.

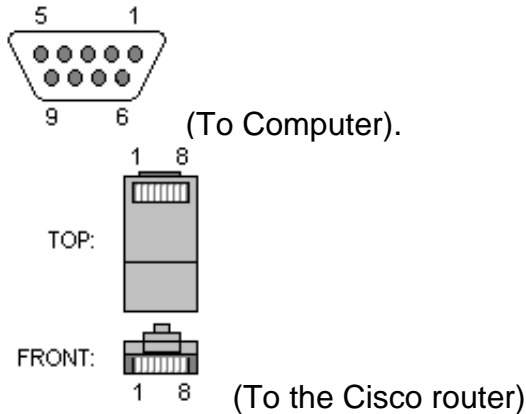

9 PIN D-SUB FEMALE to the Computer
RJ45 MALE CONNECTOR to the Cisco router.

	Female	Male	Dir
Receive Data	2	3	↑
Transmit Data	3	6	→
Data Terminal Ready	4	7	→
Ground (use as shield)	5		→
Data Set Ready	6	2	↑
Request to Send	7	8	→
Clear to Send	8	1	↑

Contributor: Joakim Ögren <qtech@mailhost.net>, Damien Miller <dmliller@vitnet.com.sg>

Source: ?

Please send any comments to Joakim Ögren <qtech@mailhost.net>.

Cisco Console (25) Cable

Use this cable to configure a Cisco router thru the Console port at the router.

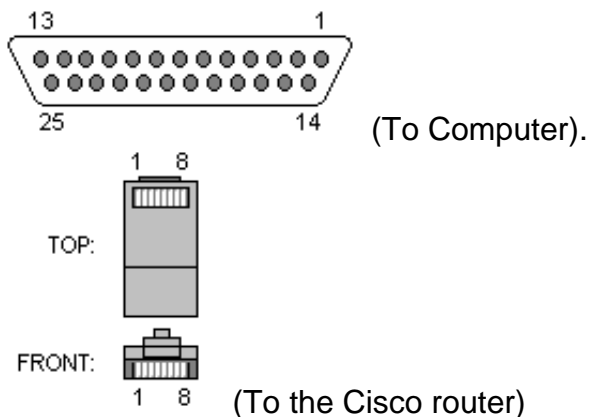

25 PIN D-SUB FEMALE to the Computer
RJ45 MALE CONNECTOR to the Cisco router.

	Female	Male	Dir
Shield Ground	1		↓
Transmit Data	2	6	→
Receive Data	3	3	←
Request to Send	4	8	→
Clear to Send	5	1	←
Data Set Ready	6	2	→
Data Terminal Ready	20	7	→

Contributor: Joakim Ögren <qtech@mailhost.net>, Damien Miller <dmliller@vitnet.com.sg>

Source: ?

Please send any comments to Joakim Ögren <qtech@mailhost.net>.

Conrad Electronics MM3610D Cable

Use this cable to connect a Conrad Electronics Multimeter 3610D to a PC's serialport.

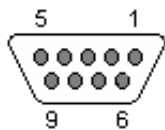

(To PC).

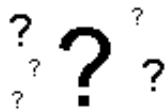

(To multimeter).

9 PIN D-SUB FEMALE to PC.

5 PIN UNKNOWN CONNECTOR to the multimeter

	PC	Conrad	Dir
Request To Send	7	1	→
Receive Data	2	2	←
Transmit Data	3	3	→
Data Terminal Ready	4	4	→
Ground	5	5	

Contributor: Joakim Ögren <qtech@mailhost.net>, Anselm Belz <a.belz@samson.mbis.de>

Source: ?

Please send any comments to Joakim Ögren <qtech@mailhost.net>.

Conrad Electronics MM3610D Cable

Use this cable to connect a Conrad Electronics Multimeter 3610D to a PC's serialport.

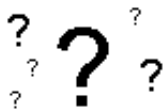
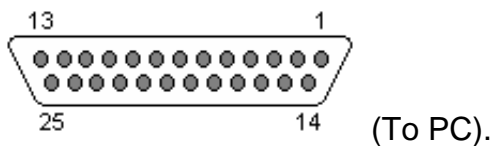

(To multimeter).

25 PIN D-SUB FEMALE to PC.

5 PIN UNKNOWN CONNECTOR to the multimeter

	PC	Conrad	Dir
Request To Send	4	1	→
Receive Data	3	2	←
Transmit Data	2	3	→
Data Terminal Ready	20	4	→
Ground	7	5	

Contributor: Joakim Ögren <qtech@mailhost.net>, Anselm Belz <a.belz@samson.mbis.de>

Source: ?

Please send any comments to Joakim Ögren <qtech@mailhost.net>.

Mac to HP48 Cable

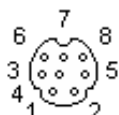

(At the Computer)

**NOT
DRAWN
YET...**

(To the HP48).

8 PIN MINI-DIN MALE to the Computer.
4 PIN ??? FEMALE to the HP48

	Mac	HP48	
TxD-	3		RxD
RxD-	5		TxD
GND+RxD+	4+8		GND
Shield	SHIELD	SHIELD	Shield

Contributor: Joakim Ögren <qtech@mailhost.net>, Pierre Olivier <olipie@aei.ca>

Sources: Usenet posting in comp.sys.cbm, Mac to C64 Interface

<http://stekt.oulu.fi/~jopi/electronics/cbm/C64_to_mac> by Tomas Moberg <fr94tmg@ing.umu.se>

Sources: Usenet posting in comp.sys.cbm, A very simple C64 to Macintosh serial cable

<http://stekt.oulu.fi/~jopi/electronics/cbm/C64_to_mac> by Chris Baird <c8923075@cs.newcastle.edu.au>

Please send any comments to Joakim Ögren <qtech@mailhost.net>.

Parallel Port Loopback (Norton)

Used to verify that a port is working. This one works with Norton Utilities: Norton Diagnostics from Symantec.

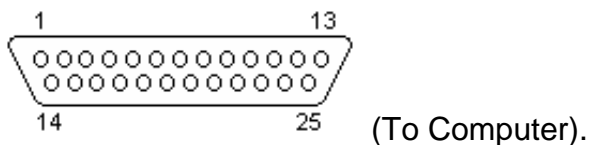

25 PIN D-SUB MALE to Computer.

Name	Pin	Pin	Name
Data Bit 0	2	15	Error
Data Bit 1	3	13	Select
Data Bit 2	4	12	Paper Out
Data Bit 3	5	10	Acknowledge
Data Bit 4	6	11	Busy

Contributor: Joakim Ögren <qtech@mailhost.net>

Source: ?

Please send any comments to Joakim Ögren <qtech@mailhost.net>.

PRELIMINARY BETA. NOT FOR REDISTRIBUTION!

Parallel Port Loopback (CheckIt)

Used to verify that a port is working. This one works with CheckIt.

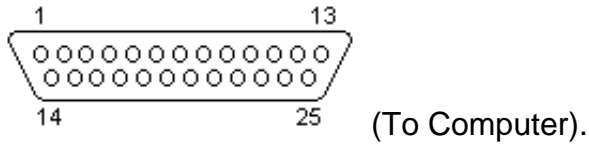

25 PIN D-SUB MALE to Computer.

Name	Pin	Pin	Name
Busy	11	17	Select Input
Acknowledge	10	16	Initialize
Paper end	12	14	Auto Feed
Select	13	1	Strobe
Data Bit 0	2	15	Error

Contributor: Joakim Ögren <qtech@mailhost.net>, "Coolsys" <coolsys@geocities.com>

Source: ?

Please send any comments to Joakim Ögren <qtech@mailhost.net>.

PRELIMINARY BETA. NOT FOR REDISTRIBUTION.

Serial Port Loopback (9 Norton)

Used to verify that a port is working. This one works with Norton Utilities: Norton Diagnostics from Symantec.

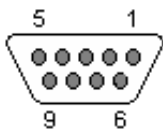

(To Computer).

9 PIN D-SUB FEMALE to Computer.

Name	Pin	Pin	Pin	Pin
Jumpering 1	2	3		
Jumpering 2	7	8		
Jumpering 3	1	4	6	9

Contributor: Joakim Ögren <qtech@mailhost.net>

Source: ?

Please send any comments to Joakim Ögren <qtech@mailhost.net>.

PRELIMINARY BETA. NOT FOR REDISTRIBUTION!

Serial Port Loopback (25 Norton)

Used to verify that a port is working. This one works with Norton Utilities: Norton Diagnostics from Symantec.

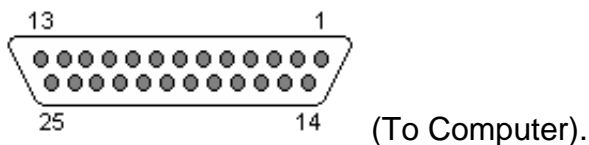

25 PIN D-SUB FEMALE to Computer.

Name	Pin	Pin	Pin	Pin
Jumpering	1	2	3	
Jumpering	2	4	5	
Jumpering	3	6	8	20
				22

Contributor: Joakim Ögren <qtech@mailhost.net>

Source: ?

Please send any comments to Joakim Ögren <qtech@mailhost.net>.

PRELIMINARY BETA. NOT FOR REDISTRIBUTION!

Serial Port Loopback (9 CheckIt)

Used to verify that a port is working. This one works with CheckIt.

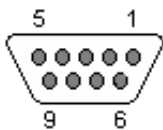

(To Computer).

9 PIN D-SUB FEMALE to Computer.

Name Pin Pin Name

CD	1	6	DSR
CD	1	9	RI
RXD	2	3	TXD
DTR	4	6	DSR
RTS	7	8	CTS

Contributor: Joakim Ögren <qtech@mailhost.net>, "Coolsys" <coolsys@geocities.com>

Source: ?

Please send any comments to Joakim Ögren <qtech@mailhost.net>.

PRELIMINARY BETA. NOT FOR REDISTRIBUTION.

Serial Port Loopback (25 CheckIt)

Used to verify that a port is working. This one works with CheckIt.

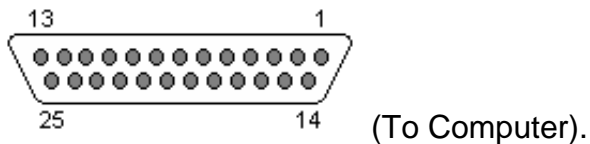

25 PIN D-SUB FEMALE to Computer.

Name	Pin	Pin	Pin	Pin
Jumpering	1	2	3	
Jumpering	2	4	5	
Jumpering	3	6	8	20
				22

Contributor: Joakim Ögren <qtech@mailhost.net>, "Coolsys" <coolsys@geocities.com>

Source: ?

Please send any comments to Joakim Ögren <qtech@mailhost.net>.

PRELIMINARY BETA. NOT FOR REDISTRIBUTION.

Floppy Cable

The original floppy cable required that each drive was jumpered to the right ID. But IBM come up with an idea to avoid jumpering the floppies.

If wire 10-16 are twisted before the last connector the jumpering is avoided. Each drive should be jumpered to act as Drive 2. If only one drive is used then leave the middle connector free.

The IDC could also be an edge connector on some old drives.

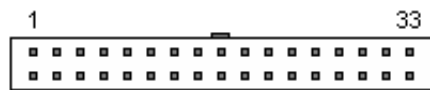
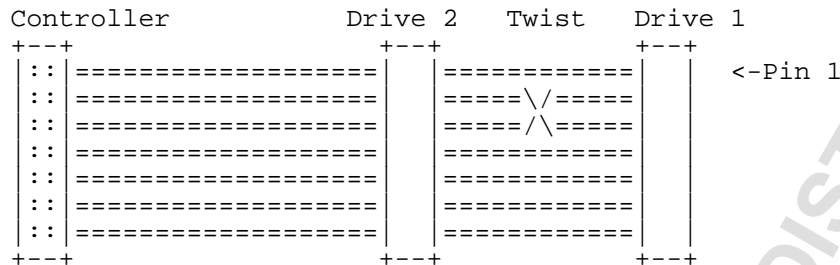

(To the Controller)

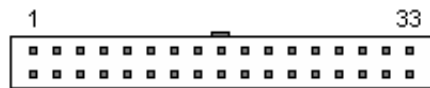

(To the Drive 2)



(To the Drive 1)

34 PIN IDC FEMALE to the Controller.

34 PIN IDC FEMALE to the Drive 2.

34 PIN IDC FEMALE to the Drive 1.

	Controller	Drive 1	Drive 2
Wire 1-9	1-9	1-9	1-9
Wire 10	10	16	10
Wire 11	11	15	11
Wire 12	12	14	12
Wire 13	13	13	13
Wire 14	14	12	14
Wire 15	15	11	15
Wire 16	16	10	16
Wire 17-34	17-34	17-34	17-34

Contributor: Joakim Ögren <qtech@mailhost.net>

Source: TheRef TechTalk <http://theref.c3d.rl.af.mil>

Please send any comments to Joakim Ögren <qtech@mailhost.net>.

IDE Cable

The IDE interface requires only one cable. All pins straight from 1 to 1, 2 to 2 and so on. The drives can be connected in any order. Only remember that one should be jumpered as Master and the other as Slave. If only one drive is used, jumper it as Single (if such a mode exists, or most common Master else).

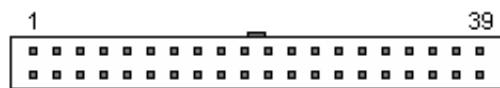
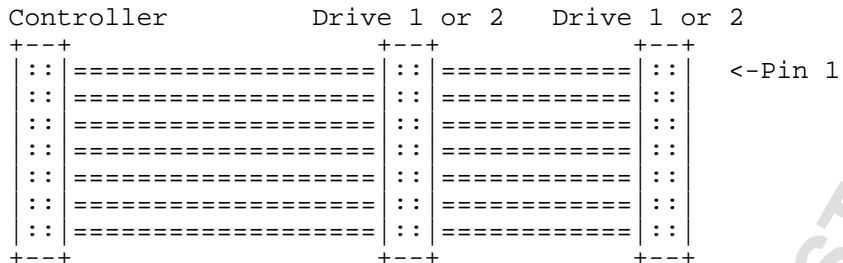

(To the Controller)

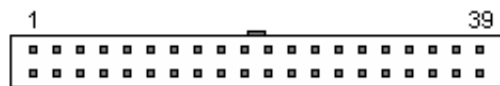

(To the Drive 1)

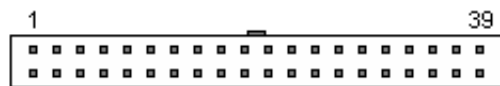

(To the Drive 2)

- 40 PIN IDC FEMALE to the Controller.
- 40 PIN IDC FEMALE to the Drive 1.
- 40 PIN IDC FEMALE to the Drive 2.

Controller Drive 1 Drive 2

Wire 1-40 1-40 1-40 1-40

Contributor: Joakim Ögren <qtech@mailhost.net>

Source: ?

Please send any comments to Joakim Ögren <qtech@mailhost.net>.

SCSI Cable (Amiga/Mac)

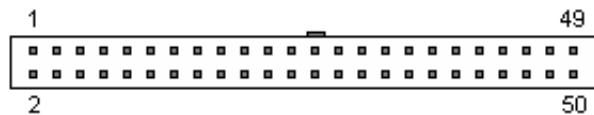
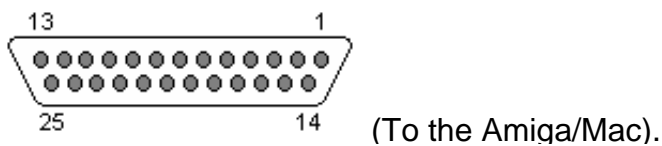

25 PIN D-SUB FEMALE to the Amiga/Mac.
50 PIN IDC FEMALE to the Peripheral.

	DSub	IDC
Request	1	48
Message	2	42
Input/Output	3	50
Reset	4	40
Acknowledge	5	38
Busy	6	36
Data Bus 0	8	2
Data Bus 3	10	8
Data Bus 5	11	12
Data Bus 6	12	14
Data Bus 7	13	16
Control/Data	15	46
Attention	17	32
Select	19	44
Data Parity	20	18
Data Bus 1	21	4
Data Bus 2	22	6
Data Bus 4	23	10
Termination Power	25	26

Note: All the other pins (7+9+14+16+18+24) at the DSub should be connected to the all odd pins except 25 at the IDC connector.

Contributor: Joakim Ögren <qtech@mailhost.net>

Source: ?

Please send any comments to Joakim Ögren <qtech@mailhost.net>.

SCSI Cable (D-Sub to Hi D-Sub)

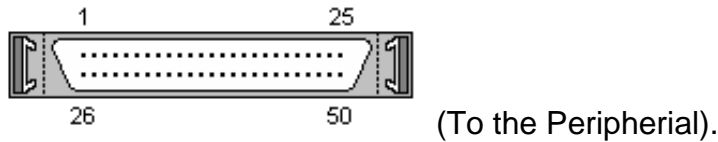
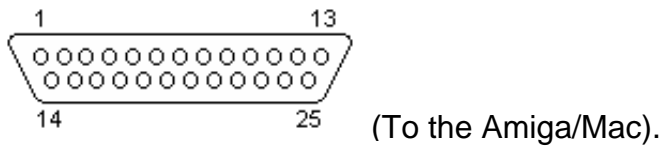

25 PIN D-SUB MALE to the Amiga/Mac.

50 PIN HI-DENSITY D-SUB MALE to the Peripheral.

	DSub	Hi DSub
Request	1	49
Message	2	46
Input/Output	3	50
Reset	4	45
Acknowledge	5	44
Busy	6	43
Data Bus 0	8	26
Data Bus 3	10	29
Data Bus 5	11	31
Data Bus 6	12	32
Data Bus 7	13	33
Control/Data	15	48
Attention	17	41
Select	19	47
Data Parity	20	34
Data Bus 1	21	27
Data Bus 2	22	28
Data Bus 4	23	30
Termination Power	25	38

Note: All the other pins (7+9+14+16+18+24) at the DSub should be connected to pins 1-25 at the Hi-density D-Sub connector.

Contributor: Joakim Ögren <qtech@mailhost.net>

Source: ?

Please send any comments to Joakim Ögren <qtech@mailhost.net>.

ST506/412 Cable

The ST506/412 interface requires two cables, one for control and one for data. The control cable is shared between the two drives. But each drive has each own data cable. By twisting some wires on the control cable it won't be necessary to set the ID for each drive, since the twist will do the job. Wires 25 to 29 should be twisted between drive 1 & drive 2.

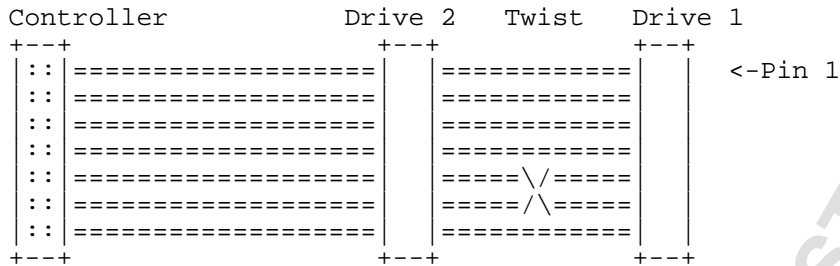

Control cable

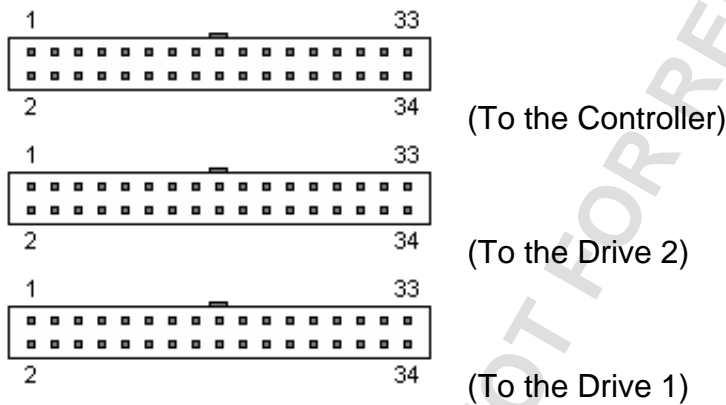

34 PIN IDC FEMALE to the Controller.
 34 PIN IDC FEMALE to the Drive 2.
 34 PIN IDC FEMALE to the Drive 1.

	Controller	Drive 1	Drive 2
Wire 1-24	1-9	1-9	1-9
Wire 25	25	29	25
Wire 26	26	28	26
Wire 27	27	27	27
Wire 28	28	26	28
Wire 29	29	25	29
Wire 30-34	30-34	30-34	30-34

Data cable

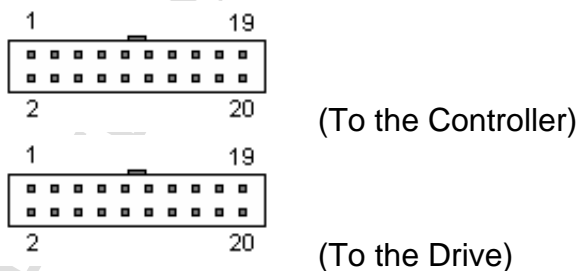

20 PIN IDC FEMALE to the Controller.
 20 PIN IDC FEMALE to the Drive.

Controller **Drive**
Wire 1-20 1-20 1-20

Contributor: Joakim Ögren <qtech@mailhost.net>

Source: TheRef TechTalk <<http://theref.c3d.rl.af.mil>>

Please send any comments to Joakim Ögren <qtech@mailhost.net>.

The Hardware Book is freely distributable but is copyrighted to Joakim Ögren. It may not be modified and re-distributed without the authors permission.

PRELIMINARY BETA. NOT FOR REDISTRIBUTION.

BETA RELEASE

ESDI Cable

The ESDI interface requires two cables, one for control and one for data. The control cable is shared between the two drives. But each drive has each own data cable. By twisting some wires on the control cable it won't be necessary to set the ID for each drive, since the twist will do the job. Wires 25 to 29 should be twisted between drive 1 & drive 2.

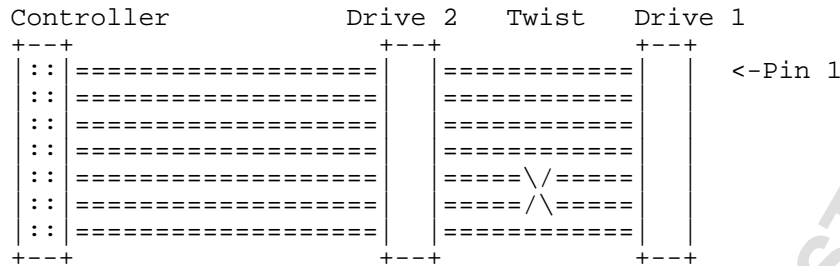

Control cable

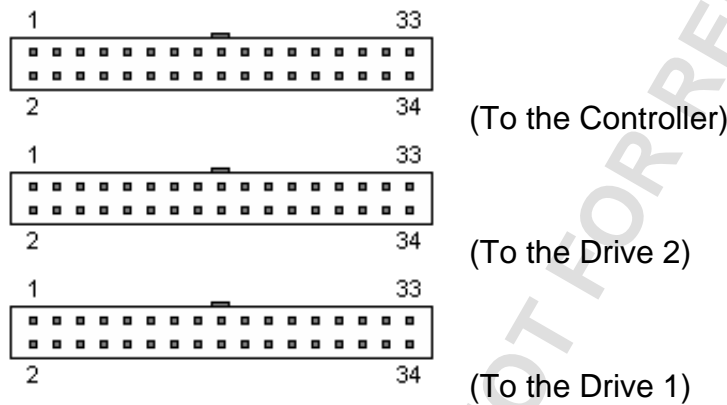

34 PIN IDC FEMALE to the Controller.
 34 PIN IDC FEMALE to the Drive 2.
 34 PIN IDC FEMALE to the Drive 1.

	Controller	Drive 1	Drive 2
Wire 1-24	1-9	1-9	1-9
Wire 25	25	29	25
Wire 26	26	28	26
Wire 27	27	27	27
Wire 28	28	26	28
Wire 29	29	25	29
Wire 30-34	30-34	30-34	30-34

Data cable

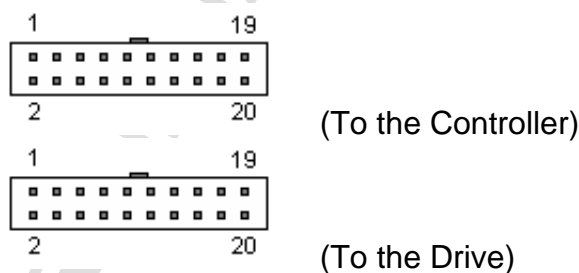

20 PIN IDC FEMALE to the Controller.
 20 PIN IDC FEMALE to the Drive.

ControllerDrive

Wire 1-20 1-20 1-20

Contributor: Joakim Ögren <qtech@mailhost.net>

Source: TheRef TechTalk <<http://theref.c3d.rl.af.mil>>

Please send any comments to Joakim Ögren <qtech@mailhost.net>.

The Hardware Book is freely distributable but is copyrighted to Joakim Ögren. It may not be modified and re-distributed without the authors permission.

PRELIMINARY BETA. NOT FOR REDISTRIBUTION.

BETA RELEASE

Paravision SX1 to IDE Cable

Can be used to connect a normal IDE harddisk to the Paravision SX1. Paravision was earlier known as Microbotics.

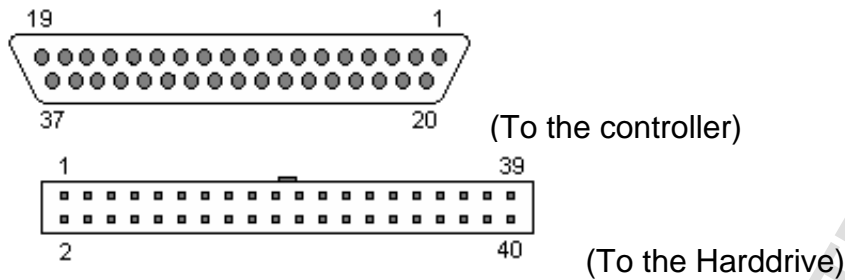

37 PIN D-SUB FEMALE to the controller.
40 PIN IDC FEMALE to the harddisk.

Description	D-Sub	IDC
Drive Reset	1	1
Data bit 0	2	17
Data bit 2	3	13
Data bit 4	4	9
Data bit 6	5	5
Ground	6	2
Data bit 8	7	4
Data bit 10	8	8
Data bit 12	9	12
Data bit 14	10	16
Ground	11+12	19
Ground	13+14	22
Ground	15+16	24
Ground	17	26
5V Power	18	n/c
5V Power	19	n/c
Ground	20	30
Data bit 1	21	21
Data bit 3	22	22
Data bit 5	23	23
Data bit 7	24	24
Ground	25	40
Data bit 9	26	26
Data bit 11	27	27
Data bit 13	28	28
Data bit 15	29	29
I/O Write	30	23
I/O Read	31	25
Interrupt Request	32	31
Address bit 2	33	36
Address bit 1	34	33
Address bit 0	35	35
Chip Select 1	36	38
Chip Select 0	37	37

Note: Pin 18+19 (+5V) can be used to power the harddisk. But most harddisks require both +5V and +12V.

Contributor: Joakim Ögren <qtech@mailhost.net>

Source: ?

Please send any comments to Joakim Ögren <qtech@mailhost.net>.

BETA RELEASE

Video to TV SCART cable

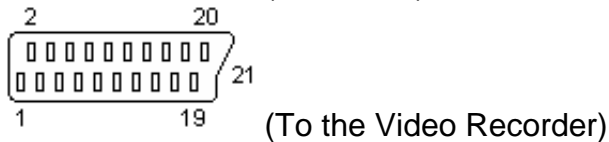
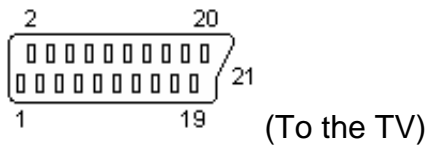

21 PIN SCART MALE to the TV.

21 PIN SCART MALE to the Video Recorder.

		TV VCR			
Audio Right Out	1	2	Audio Right In		
Audio Right In	2	1	Audio Right Out		
Audio Left Out	3	6	Audio Left In		
Audio Left In	6	3	Audio Left Out		
Audio Ground	4	4	Audio Ground		
Red	15	15	Red		
Red Ground	13	13	Red Ground		
Green	11	11	Green		
Green Ground	9	9	Green Ground		
Blue	7	7	Blue		
Blue Ground	5	5	Blue Ground		
Status / 16:9	8	8	Status / 16:9		
Reserved	10	10	Reserved		
Reserved	12	12	Reserved		
Fast Blanking Ground	14	14	Fast Blanking Ground		
Fast Blanking	16	16	Fast Blanking		
Video Out Ground	17	18	Video In Ground		
Video In Ground	18	17	Video Out Ground		
Video Out	19	20	Video In		
Video In Ground	20	19	Video Out		
Ground	21	21	Ground		

Contributor: Joakim Ögren <qtech@mailhost.net>

Source: ?

Please send any comments to Joakim Ögren <qtech@mailhost.net>.

Amiga to SCART cable

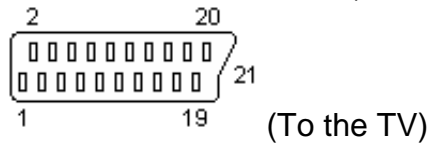
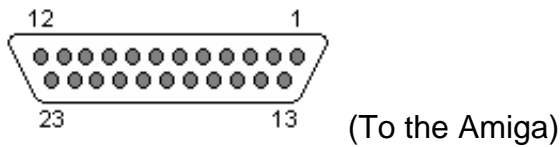

23 PIN D-SUB FEMALE to the Amiga
21 PIN SCART MALE to the TV

	Amiga	TV	
Analog Red	3	15	RGB Red In
Analog Green	4	11	RGB Green In
Analog Blue	5	7	RGB Blue In
Composite Sync	10	20	Video In
Video GND	17	17	Video GND
GND	19	18	Blanking GND
+12V	22	16	Blanking (Connect via a 150 Ohm resistor)
+12V	22	8	Audio/RGB switch (Connect via a 1 kOhm resistor)
Phono Right		2	Audio IN Right
Phono Right GND		4	GND
Phono Left		6	Audio IN Left
Phono Left GND		4	GND

Contributor: Joakim Ögren <qtech@mailhost.net>

Source: ?

Please send any comments to Joakim Ögren <qtech@mailhost.net>.

9 to 15 pin VGA cable

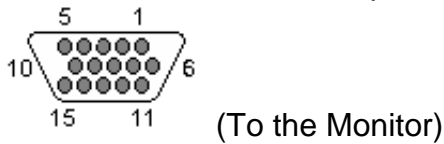
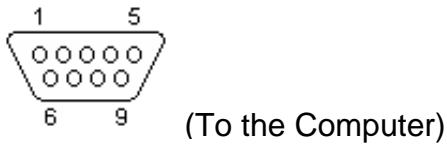

9 PIN D-SUB MALE to the Computer

15 PIN HIGHDENSITY D-SUB FEMALE to the Monitor

	9-Pin	15-Pin
Red Video	1	1
Green Video	2	2
Blue Video	3	3
Horizontal Sync	4	13
Vertical Sync	5	14
Red GND	6	6
Green GND	7	7
Blue GND	8	8
Sync GND	9	10 + 11

Contributor: Joakim Ögren <qtech@mailhost.net>

Source: ?

Please send any comments to Joakim Ögren <qtech@mailhost.net>.

Amiga to C1084 Monitor Cable

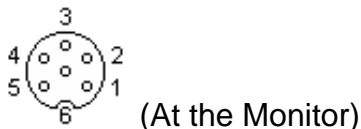
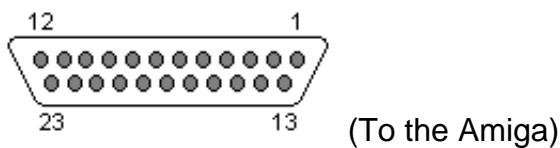

23 PIN D-SUB FEMALE to the Amiga.
6 PIN DIN MALE at the Monitor.

Amiga C1084			
R	3	4	R
G	4	1	G
B	5	5	B
SYNC	10	2	HSYNC
GND	16	3	GND

Contributor: Joakim Ögren <qtech@mailhost.net>

Source: Usenet posting in sfnet.harrastus.elektroniikka, Philips 1084 monarin kytkenta
<http://www.vuse.vanderbilt.edu/~thompsbb/cbm_conn.txt> by Kari Hautanen <kari.hautanen@compart.fi>

Please send any comments to Joakim Ögren <qtech@mailhost.net>.

C128/C64C to CBM 1902A Monitor Cable

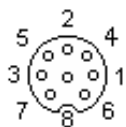

(At the Computer)



(At the Monitor)

8 PIN DIN (DIN45326) MALE at the Computer.

6 PIN DIN MALE at the Monitor.

Computer C1902A

LUM	1	6	LUM
CHROMA	8	4	CHROMA
GND	2	3	GND
AOUT	3	2	AUDIO

Contributor: Joakim Ögren <qtech@mailhost.net>

Source: cbm.comp.sys General FAQ v3.1 Part 7

<<http://www.lib.ox.ac.uk/internet/news/faq/archive/cbm-main-faq.3.1.p7.html>>

Please send any comments to Joakim Ögren <qtech@mailhost.net>.

C128/C64C to SCART (S-Video) Cable

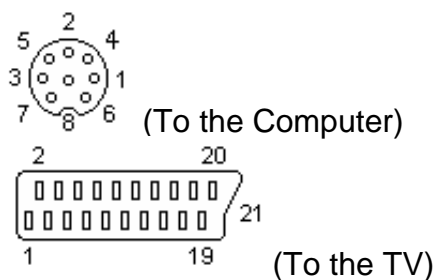

8 PIN DIN (DIN45326) MALE at the Computer.
21 PIN SCART MALE to the TV

	Computer		TV	
LUM	1	20	LUM	
CHROMA	8	15	CHROMA	
GND	2	4+17	GND	
AOUT	3	2+6	AUDIO	

Contributor: Joakim Ögren <qtech@mailhost.net>, Claudio Brazzale <brzcl@dei.unipd.it>

Source: ?

Please send any comments to Joakim Ögren <qtech@mailhost.net>.

NeoGeo to SCART Cable

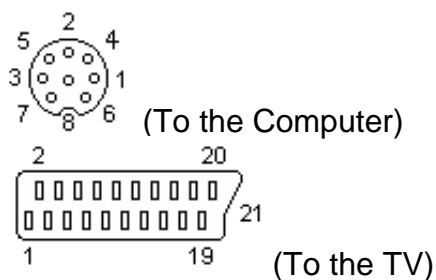

8 PIN DIN (DIN45326) MALE to the Computer.
21 PIN SCART MALE to the TV

	NeoGeo	TV
Audio Out	1	6+2 Audio In Left+Right
Ground	2	18 Blanking Signal Ground
Composite Video Out	3	20 Composite Video In
?	4	16 Blanking Signal
Green	5	11 RGB Green In
Red	6	15 RGB Red In
Blue	8	7 RGB Blue In

Contributor: Joakim Ögren <qtech@mailhost.net>, Enzo <enzo@gaiant.net>, Steffen Kupfer <Steffen_Kupfer@compuserve.com>

Source: ?

Please send any comments to Joakim Ögren <qtech@mailhost.net>.

Ethernet 10/100Base-T Crossover Cable

This cable can be used to cascade hubs, or for connecting two Ethernet stations back-to-back without a hub. It works with both 10Base-T and 100Base-TX.

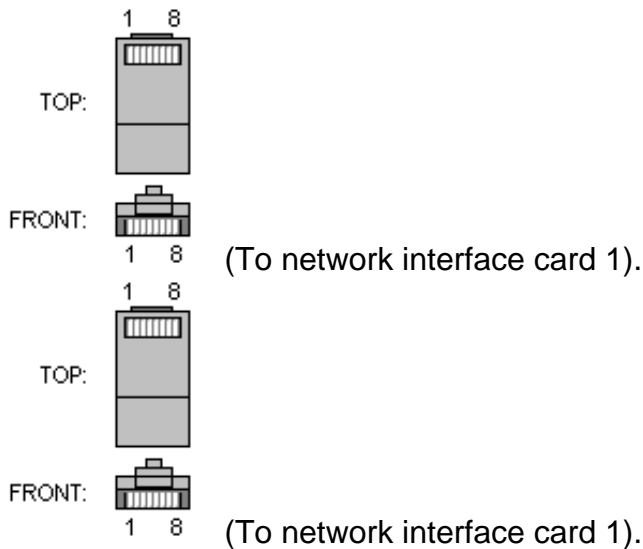

RJ45 MALE CONNECTOR to network interface card 1.
 RJ45 MALE CONNECTOR to network interface card 2.

Name	Pin	Pin	Name
TX+	1	3	RX+
TX-	2	6	RX-
RX+	3	1	TX+
RX-	6	2	TX-

Note 1: It's important that each pair is kept as a pair. TX+ & TX- must be in the pair, and RX+ & RX- must together in another pair. (Just as the table above shows).

Note 2: You could also connect 4-4, 5-5, 7-7, 8-8.

Contributors: Joakim Ögren <qtech@mailhost.net>, Jim C? <jimc@megalink.net>, Jason D. Pero <JDP6640@ritvax.isc.rit.edu>, Oscar Fernandez Sierra <oscar@charpy.etsiig.uniovi.es>, Cayce Balara <CayceB@yardboy.com>, Jeffrey R. Broido <broidoj@gti.net>

Source: ?

Please send any comments to Joakim Ögren <qtech@mailhost.net>.

Ethernet 10/100Base-T Straight Thru Cable

This cable will work with both 10Base-T and 100Base-TX and is used to connect a network interface card to a hub or network outlet. These cables are sometimes called "whips".

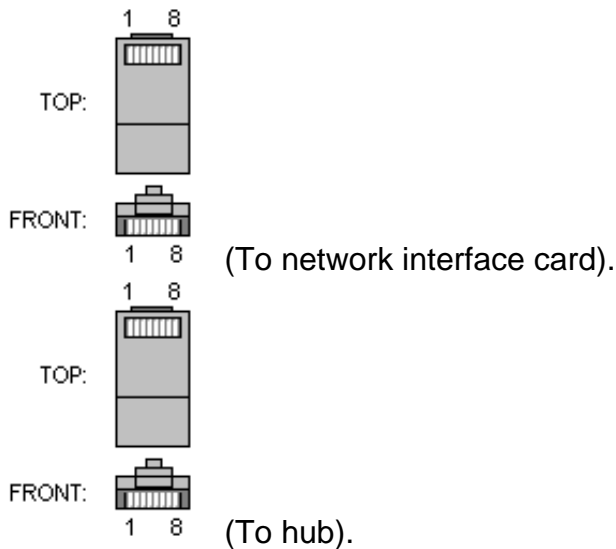

RJ45 MALE CONNECTOR to network interface card).
RJ45 MALE CONNECTOR to hub).

Name	Pin	Cable Color	Pin Name
TX+	1	White/Orange	1 TX+
TX-	2	Orange	2 TX-
RX+	3	White/Green	3 RX+
	4	Blue	4
	5	White/Blue	5
RX-	6	Green	6 RX-
	7	White/Brown	7
	8	Brown	8

Note: It's important that each pair is kept as a pair. TX+ & TX- must be in the pair, and RX+ & RX- must together in another pair. (Just as the table above shows).

Just for your information, this is how the pairs are named:

Pair	Pins	Common color
1	4 & 5	Blue
2	1 & 2	Orange
3	3 & 6	Green
4	7 & 8	Brown

The + side of each pair is called the "tip" and the - side is called the "ring", a reference to old telephone connectors.

Contributor: Joakim Ögren <qtech@mailhost.net>, Oscar Fernandez Sierra <oscar@charpy.etsiig.uniovi.es>, Jeffrey R. Broido <broidoj@gti.net>

Source: ?

Please send any comments to Joakim Ögren <qtech@mailhost.net>.

Ethernet 100Base-T4 Crossover Cable

This cable can be used to cascade hubs, or for connecting two Ethernet stations back-to-back without a hub.

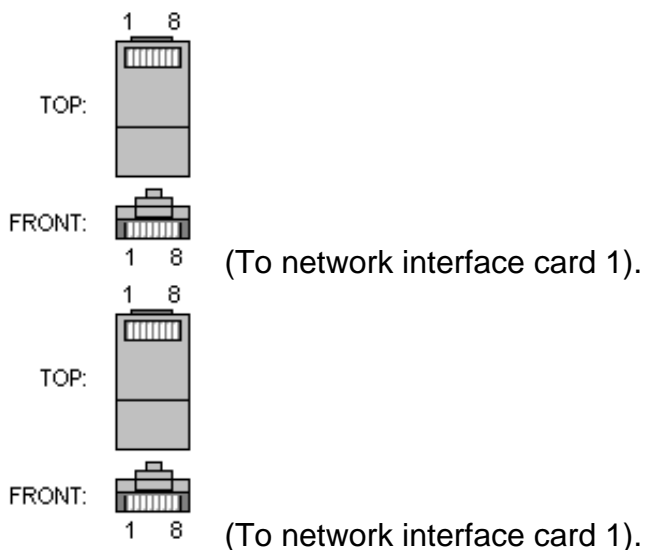

RJ45 MALE CONNECTOR to network interface card 1.

RJ45 MALE CONNECTOR to network interface card 2.

Name	Pin	Pin	Pin Name
TX_D1+	1	3	RX_D2+
TX_D1-	2	6	RX_D2-
RX_D2+	3	1	TX_D1+
RX_D2-	6	2	TX_D1-
BI_D3+	4	7	BI_D4+
BI_D3-	5	8	BI_D4-
BI_D4+	7	4	BI_D3+
BI_D4-	8	5	BI_D3-

Note 1: It's important that each pair is kept as a pair. TX+ & TX- must be in the pair, and RX+ & RX- must together in another pair etc. (Just as the table above shows).

Contributors: Joakim Ögren <qtech@mailhost.net>, Kim Scholte <KScholte@BigFoot.Com>

Source: ?

Please send any comments to Joakim Ögren <qtech@mailhost.net>.

ParaLoad Cable

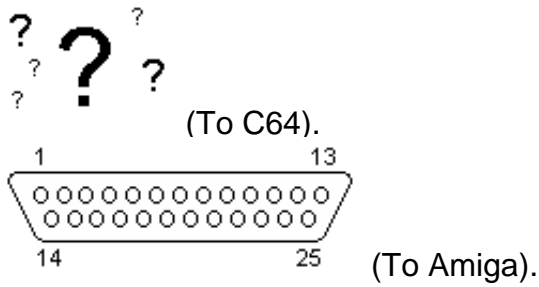

DZM 12 DREH at the C64 UserPort.
25 PIN D-SUB MALE at the Amiga

	C64	Amiga	
Ground	A	17-25	Ground
FLAG2	B	1	Strobe
PB0	C	2	D0
PB1	D	3	D1
PB2	E	4	D2
PB3	F	5	D3
PB4	H	6	D4
PB5	J	7	D5
PB6	K	8	D6
PB7	L	9	D7
PA2	M	11	Busy

Contributor: Joakim Ögren <qtech@mailhost.net>

Source: ParaLoad documentation

Please send any comments to Joakim Ögren <qtech@mailhost.net>.

X1541 Cable

Used to transfer data from a Commodore 1541/1581 diskdrive to a PC. The X1541 software is written by Leopoldo Ghielmetti <GHIELMET@eldi.epfl.ch>.

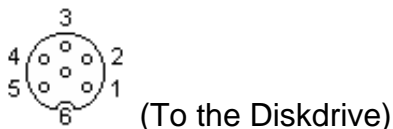
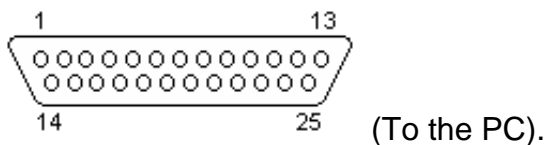

25 PIN D-SUB MALE to the PC.

6 PIN DIN (DIN45322) MALE to the Cable

	PC	Diskdrive	
GND	18-25	2	GND
STROBE	1	3	ATN
AUTOFEED	14	4	CLOCK
SELECTIN	17	5	DATA
INIT	16	6	RESET

Contributor: Joakim Ögren <qtech@mailhost.net>, Magnus.Eriksson <magnus.eriksson@mbox309.swipnet.se>

Source: X1541 documentation

Please send any comments to Joakim Ögren <qtech@mailhost.net>.

MIDI Cable

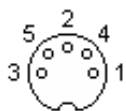

(To the 1st peripheral)

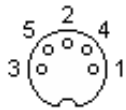

(To the 2nd peripheral)

5 PIN DIN 180° (DIN41524) MALE to the 1st peripheral.

5 PIN DIN 180° (DIN41524) MALE to the 1st peripheral.

	1st	2nd
Shield	2	2
Current Source	4	4
Current Sink	5	5

Note: Although that pin 2 only is connected at MIDI Out it's simpler to connect it to both ends.

Contributor: Joakim Ögren <qtech@mailhost.net>

Source: ?

Please send any comments to Joakim Ögren <qtech@mailhost.net>.

Misc unsupported Cables

These cables may or may not be correctly constructed. Handle with care.

Amiga to IBM RGBI Cable

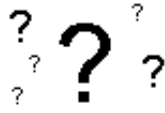

(To the Monitor).

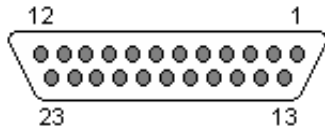

(To the Amiga).

9 PIN D-SUB ?? to the Monitor.

23 PIN D-SUB FEMALE to the Amiga.

	9 Pin	23 Pin	Comment
Ground	1	16	
Ground	2	16	
Digital Red	3	9	(Via 2 Hex Inverters, i.e 74LS04)
Digital Green	4	8	(Via 2 Hex Inverters, i.e 74LS04)
Digital Blue	5	9	(Via 2 Hex Inverters, i.e 74LS04)
Digital Intensity	6	6	(Via 2 Hex Inverters, i.e 74LS04)
Horizontal Sync	8	11	(Via 1 Hex Inverters, i.e 74LS04)
Verical Sync	9	12	(Via 1 Hex Inverters, i.e 74LS04)
+5V		23	(Power for the IC)

C128 80 columns to 1702 monitor Cable

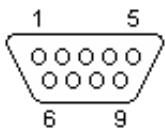

(To the C128).

**NOT
DRAWN
YET...**

(To the C1702).

9 PIN D-SUB MALE to the C128.

PHONO MALE to the Monitor.

	C128	C1702	
Ground	1	1	Ground
Monochrome out	7	2	Signal

Contributor: Joakim Ögren <qtech@mailhost.net>

Source: Gordon <GAJ2@psuvm.psu.edu>

Please send any comments to Joakim Ögren <qtech@mailhost.net>.

Chapter 4

Adapter Menu

What does the the information that is listed for each adapter mean? See the tutorial.

Serial:

- Nullmodem adapter
- 9p to 25p Serial adapter

Parallel:

- Centronics to LapLink adapter **NEW**

Keyboard:

- Mini-DIN to DIN Keyboard adapter
- DIN to Mini-DIN Keyboard adapter
- PS/2 Keyboard (Gateway) Y Adapter
- PS/2 Keyboard (IBM Thinkpad) Y Adapter

Mouse:

- PS/2 to Serial Mouse Adapter
- Serial to PS/2 Mouse Adapter

Joysticks:

- Amiga 4 Joysticks adapter
- PC 2 Joysticks adapter

Video:

- Macintosh Video to VGA Adapter **NEW**

Misc:

- A1000 to Amiga Parallel adapter

Last updated 1997-08-31.

(C) Joakim Ögren <qtech@mailhost.net> 1996,1997

Short tutorial

Heading

First at each page there a short heading describing the adapter.

Pictures of the connectors

After that there is at each page there is one or more pictures of the connectors, usually there's two connectors. Sometimes there is some question marks only. This means that I don't know what kind of connector it is or how it looks.

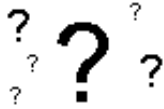

(To the computer)

There may be some pictures I haven't drawn yet. I illustrate this with the following advanced picture:

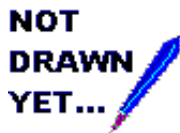

(To the computer)

Normally are one or more pictures. **These are seen from the front, and NOT the soldside. Holes (female connectors usually) are darkened.** Look at the example below. The first is a female connector and the second a male. The texts inside parentheses will tell you at which kind of the device it will look like that.

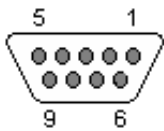

(To the Computer).

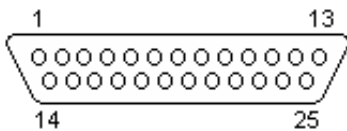

(To the Serialcable).

Texts describing the connectors

Below the pictures there is texts that describes the connectors. Including the name of the physical connector.

9 PIN D-SUB FEMALE to the Computer.

25 PIN D-SUB MALE to the Serialcable.

Pin table

The pin table is perhaps the information you're looking for. Should be simple to read. Contains mostly the following three columns; Name, Pin 1, Pin 2. Sometimes when not the same pin is connected to each side there is another column describing the name at connector 2.

	9-Pin	25-Pin
Carrier Detect	1	8
Receive Data	2	3
Transmit Data	3	2
Data Terminal Ready	4	20

System Ground	5	7
Data Set Ready	6	6
Request to Send	7	4
Clear to Send	8	5
Ring Indicator	9	22

Contributor & Source

All persons that helped me or sent me information about the connector will be listed here. The source of the information is perhaps a book or another site. I must admit that I'm bad at writing the source, but I'll try to fill in these in the future.

Contributor: Joakim Ögren <qtech@mailhost.net>

Source: Amiga 4000 User's Guide from Commodore

Nullmodem Adapter

This adapter will enable you to use a normal serialcable as a nullmodem.

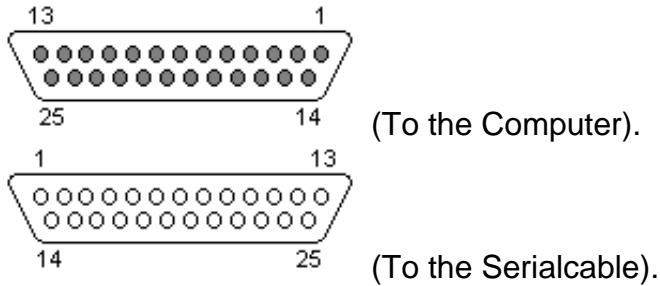

25 PIN D-SUB FEMALE to the Computer.

25 PIN D-SUB MALE to the Serialcable.

	Female Male		
Shield Ground	1	1	Shield Ground
Transmit Data	2	3	Receive Data
Receive Data	3	2	Transmit Data
Request to Send	4	5	Clear to Send
Clear to Send	5	4	Request to Send
Data Set Ready	6	20	Data Terminal Ready
Data Terminal Ready	20	6	Data Set Ready
Ground	7	7	Ground

Contributor: Joakim Ögren <qtech@mailhost.net>

Source: ?

Please send any comments to Joakim Ögren <qtech@mailhost.net>

9 to 25 Serial Adapter

This adapter will enable you to connect a 25 pin serial cable to a 9 pin connector at the computer.

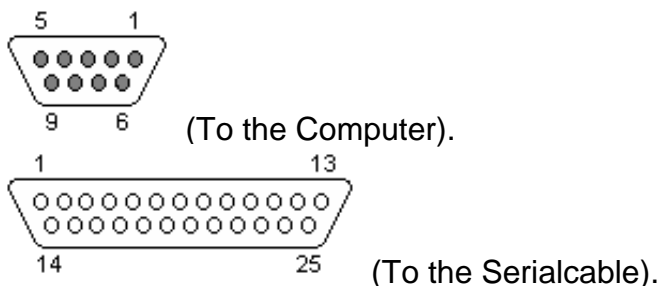

9 PIN D-SUB FEMALE to the Computer.
25 PIN D-SUB MALE to the Serialcable.

	9-Pin	25-Pin
Carrier Detect	1	8
Receive Data	2	3
Transmit Data	3	2
Data Terminal Ready	4	20
System Ground	5	7
Data Set Ready	6	6
Request to Send	7	4
Clear to Send	8	5
Ring Indicator	9	22

Contributor: Joakim Ögren <qtech@mailhost.net>

Source: ?

Please send any comments to Joakim Ögren <qtech@mailhost.net>.

Centronics to LapLink Adapter

This adapter will allow you to use a normal printercable (Centronics) as a LapLink/InterLink cable.

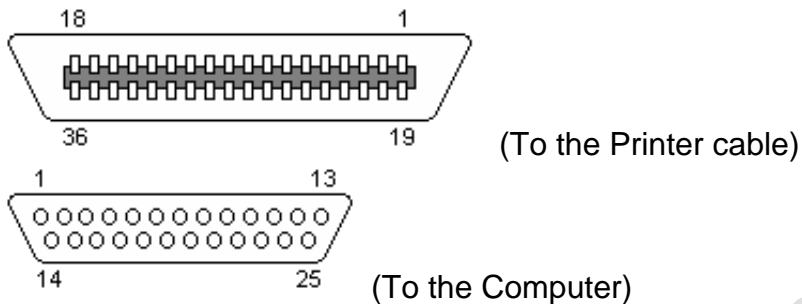

36 PIN CENTRONICS FEMALE to the Printer cable.
25 PIN D-SUB MALE to the Computer.

Name	36-Cen	25-DSub	Name
Data Bit 0	2	15	Error
Data Bit 1	3	13	Select
Data Bit 2	4	12	Paper Out
Data Bit 3	5	10	Acknowledge
Data Bit 4	6	11	Busy
Acknowledge	10	5	Data Bit 3
Busy	11	6	Data Bit 4
Paper Out	12	4	Data Bit 2
Select	13	3	Data Bit 1
Error	32	2	Data Bit 0
Reset	16	16	Reset
Select	17	17	Select
Signal Ground	19-30+33	18-25	Signal Ground

Contributor: Joakim Ögren <qtech@mailhost.net>, Petr Krc <magneton@mail.firstnet.cz>

Source: ?

Please send any comments to Joakim Ögren <qtech@mailhost.net>.

Mini-DIN to DIN Keyboard Adapter

This adapter will enable you to use a keyboard with a 6 pin Mini-DIN connector to a computer with a 5 pin DIN connector.

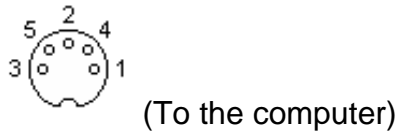
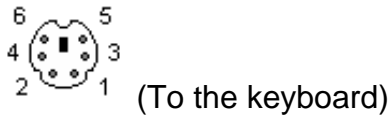

6 PIN MINI-DIN FEMALE (PS/2 STYLE) to the keyboard.

5 PIN DIN 180° (DIN41524) MALE to the computer.

	Mini-DIN	DIN
Shield	Shield	Shield
Data	1	2
Ground	3	4
+5 VDC	4	5
Clock	5	1

Contributor: Joakim Ögren <qtech@mailhost.net>, Gilles Ries <gries@glo.be>

Source: ?

Please send any comments to Joakim Ögren <qtech@mailhost.net>.

DIN to Mini-DIN Keyboard Adapter

This adapter will enable you to use a keyboard with a 5 pin DIN connector to a computer with a 6 pin Mini-DIN connector.



(To the keyboard)



(To the computer)

5 PIN DIN 180° (DIN41524) FEMALE to the keyboard.

6 PIN MINI-DIN MALE (PS/2 STYLE) to the computer.

	DIN	Mini-DIN
Shield	Shield	Shield
Clock	1	5
Data	2	1
Ground	4	3
+5 VDC	5	4

Contributor: Joakim Ögren <qtech@mailhost.net>, Gilles Ries <gries@glo.be>

Source: ?

Please send any comments to Joakim Ögren <qtech@mailhost.net>.

PS/2 Keyboard (Gateway) Y Adapter

This adapter will enable you to use a keyboard and mouse at the same time. For Gateway computer, may work with other computers (Let me know).

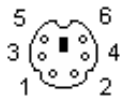

(To the Computer)

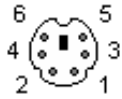

(To the Keyboard)



(To the Mouse)

6 PIN MINI-DIN MALE (PS/2 STYLE) to the Computer.

6 PIN MINI-DIN FEMALE (PS/2 STYLE) to the Keyboard.

6 PIN MINI-DIN FEMALE (PS/2 STYLE) to the Mouse.

Computer Keyboard Mouse

1	2	-
2	-	2
3	3	3
4	4	4
5	6	-
6	-	6

Contributor: Joakim Ögren <qtech@mailhost.net>, Gilles Ries <gries@glo.be>

Source: Tommy's pinout Collection <<http://csgrad.cs.vt.edu/~tjohnson/pinouts>> by Tommy Johnson <tjohnson@csgrad.cs.vt.edu>

Please send any comments to Joakim Ögren <qtech@mailhost.net>.

PS/2 Keyboard (IBM Thinkpad) Y Adapter

This adapter will enable you to use a keyboard and mouse at the same time. For IBM Thinkpad computer, may work with other computers (Let me know).

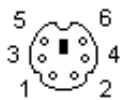

(To the Computer)

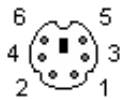

(To the Keyboard)



(To the Mouse)

6 PIN MINI-DIN MALE (PS/2 STYLE) to the Computer.

6 PIN MINI-DIN FEMALE (PS/2 STYLE) to the Keyboard.

6 PIN MINI-DIN FEMALE (PS/2 STYLE) to the Mouse.

Computer Keyboard Mouse

1	2	-
2	-	1,2
3	3	3
4	4	4
5	6	5
6	-	6

Contributor: Joakim Ögren <qtech@mailhost.net>, Gilles Ries <gries@glo.be>

Source: Tommy's pinout Collection <<http://csgrad.cs.vt.edu/~tjohnson/pinouts>> by Tommy Johnson <tjohnson@csgrad.cs.vt.edu>

Please send any comments to Joakim Ögren <qtech@mailhost.net>.

PS/2 to Serial Mouse Adapter

This adapter will enable you to use a mouse with a 6 pin Mini-DIN (PS/2) connector to a computer with a 9 pin D-SUB (Serial) connector.

This requires that the mouse handles both protocols. A mouse like this is sometimes referred to as a combo-mouse.

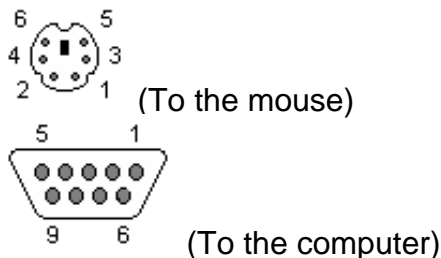

6 PIN MINI-DIN FEMALE to the mouse.

9 PIN D-SUB FEMALE to the computer.

Mini-DIN D-SUB

GND	3	5	GND
RxD	2	2	RxD
TxD	6	3	TxD
+5V	4	7	RTS

Contributor: Joakim Ögren <qtech@mailhost.net>, Tomas Ögren <stric@ts.umu.se>, Thomas Eschenbacher <Thomas.H.Eschenbacher@stud.uni-erlangen.de>

Source: ?

Please send any comments to Joakim Ögren <qtech@mailhost.net>.

Serial to PS/2 Mouse Adapter

This adapter will enable you to use a mouse with a 9 pin D-SUB (Serial) connector to a computer with a 6 pin Mini-DIN (PS/2) connector.

This requires that the mouse handles both protocols. A mouse like this is sometimes referred to as a combo-mouse.

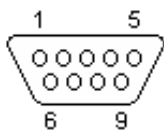

(To the mouse)



(To the computer)

9 PIN D-SUB MALE to the mouse.

6 PIN MINI-DIN MALE to the computer.

Mini-DIN D-SUB

+5V	4	4+7+9	DTR+RTS+RI
Data	1	1	CD
Gnd	3	3+5	TXD+GND
Clock	5	6	DSR

Contributor: Joakim Ögren <qtech@mailhost.net>, Tomas Ögren <stric@ts.umu.se>, Thomas Eschenbacher <Thomas.H.Eschenbacher@stud.uni-erlangen.de>

Source: ?

Please send any comments to Joakim Ögren <qtech@mailhost.net>.

Amiga 4 Joysticks adapter

This adapter will make it possible to connect 2 extra joysticks to the Amiga. This requires that the game is aware of this Multi-Joystick Extender in order to use it.

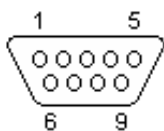

(To the 1st Joystick).

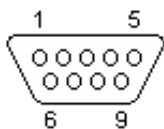

(To the 2nd Joystick).

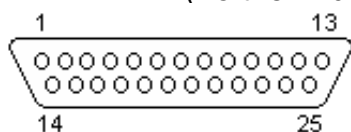

(To the Computer).

9 PIN D-SUB MALE to the 1st Joystick.

9 PIN D-SUB MALE to the 2nd Joystick.

25 PIN D-SUB MALE to the Serialcable.

	Parport	Joy 1	Joy 2
Up 1	2	1	
Down 1	3	2	
Left 1	4	3	
Right 1	5	4	
Up 2	6		1
Down 2	7		2
Left 2	8		3
Right 2	9		4
Fire 2	11		6
Fire 1	13	6	
Ground 2	18		8
Ground 1	19	8	

Contributor: Joakim Ögren <qtech@mailhost.net>

Source: Tomi Engdahl's Joystick page <<http://www.hut.fi/~then/circuits/joystick.html>>

Please send any comments to Joakim Ögren <qtech@mailhost.net>.

PC 2 Joysticks adapter

This adapter will make it possible to connect 1 extra joystick to the PC. The gameport contains pins for two joysticks but you'll need this adapter to be able to connect two joysticks to one connector.

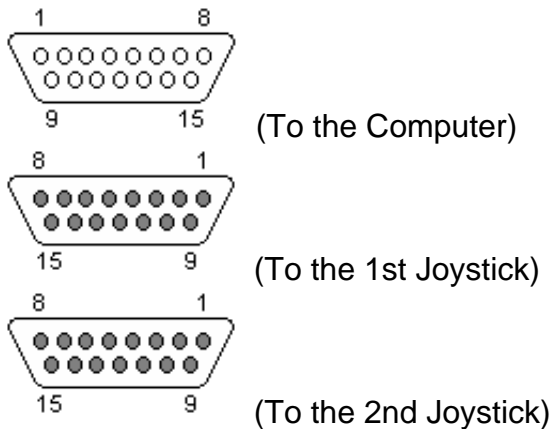

15 PIN D-SUB MALE to the Computer.
15 PIN D-SUB FEMALE to the 1st Joystick.
15 PIN D-SUB FEMALE to the 2nd Joystick.

	PC	Joy 1	Joy 2
+5 VDC	1	1	-
Button 1	2	2	
Joystick 1 - X	3	3	
Ground	4	4	4
Ground	5	5	5
Joystick 1 - Y	6	6	
Button 2	7	7	
+5 VDC	8	8	
+5 VDC	9	9	1
Button 4	10	10	2
Joystick 2 - X	11	11	3
Ground	12	12	
Joystick 2 - Y	13	13	6
Button 3	14	14	7
+5 VDC	15	15	8

Note: Since pin 12 is often used for MIDI-signals on gameport equipped soundcards it's better to use the ground from pin 4 & 5, pin 15 is also used for MIDI-signals...

Contributor: Joakim Ögren <qtech@mailhost.net>

Source: Tomi Engdahl's Joystick page <<http://www.hut.fi/~then/circuits/joystick.html>>

Please send any comments to Joakim Ögren <qtech@mailhost.net>.

Macintosh to VGA Video

Use this adapter to connect a standard VGA (or higher) monitor to your Apple Macintosh.

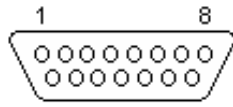

(To the Computer)

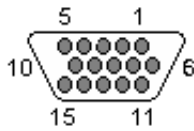

(To the Monitor-cable)

15 PIN D-SUB MALE to the Computer.

15 PIN HIGHDENSITY D-SUB FEMALE to the Monitor-cable.

Description	Mac	VGA	Dir
Red Ground	1	6	↓
Red	2	1	↑
Composite sync	3	13	↑
Monitor Sense 0	4	4	↑
Green	5	2	↑
Green Ground	6	7	↓
Monitor Sense 1	7	11	↑
No connection	8	n/c	
Blue	9	3	↑
Monitor sense 2	10	12	↑
Sync Ground	11	10	↓
Vertical Sync	12	14	↓
Blue Ground	13	8	↓
Horizontal Sync Ground	14	n/c	
Horizontal Sync	15	n/c	

Contributor: Joakim Ögren <qtech@mailhost.net>, Michael Van den Acker <rdsmv@huntsman.cse.rmit.edu.au>

Source: ?

Please send any comments to Joakim Ögren <qtech@mailhost.net>.

A1000 to Amiga Parallel Adapter

This adapter will enable you to connect normal Amiga peripherals to an Amiga 1000. The Amiga 1000 has a male connector at the computer instead of a normal female connector. And some signals has changed places.

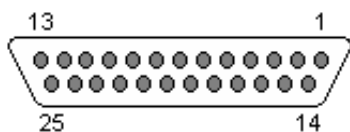

(To the Amiga 1000).

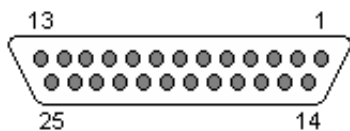

(To the Amiga peripheral).

25 PIN D-SUB FEMALE to the Amiga 1000.

25 PIN D-SUB FEMALE to the Amiga peripheral.

A1000 Amiga

Ground	14	23
Ground	15	24
Ground	16	25
+5V	23	14
n/c	24	15
Reset	25	16

All other straight over, 1 to 1, 2 to 2...

Contributor: Joakim Ögren <qtech@mailhost.net>

Source: ?

Please send any comments to Joakim Ögren <qtech@mailhost.net>.

Chapter 5

Misc Menu

Active Filters:

- Butterworth 1st order Lowpass
- Butterworth 1st order Highpass
- Butterworth 2nd order Lowpass
- Butterworth 2nd order Highpass
- Butterworth 3rd order Lowpass
- Butterworth 3rd order Highpass
- Butterworth 4th order Lowpass
- Butterworth 4th order Highpass
- Bessel 2nd order Lowpass
- Bessel 2nd order Highpass
- Bessel 3rd order Lowpass
- Bessel 3rd order Highpass
- Bessel 4th order Lowpass
- Bessel 4th order Highpass
- Linkwitz 4th order Lowpass
- Linkwitz 4th order Highpass

Definitions:

- DTE & DCE

Last updated 1997-08-31.

(C) Joakim Ögren <qtech@mailhost.net> 1996, 1997

Active Filter: Butterworth (1st order, 6 dB/octave, Lowpass)

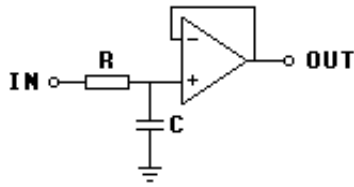

$R=4.7k-10\text{ k}\Omega$

$C=1.000/(2*\pi*F_c*R)$

Units: R [Ω], C [F], F_c [Hz]

Contributor: Joakim Ögren <qtech@mailhost.net>

Source: ?

Please send any comments to Joakim Ögren <qtech@mailhost.net>

Active Filter: Butterworth (1st order, 6 dB/octave, Highpass)

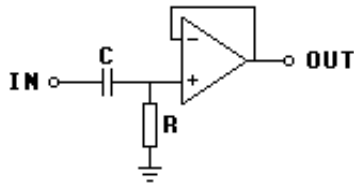

$C=4.7\text{n}-10\text{nF}$

$R=1.000/(2*\pi*F_c*C)$

Units: R [Ohm], C [F], F_c [Hz]

Contributor: Joakim Ögren <qtech@mailhost.net>

Source: ?

Please send any comments to Joakim Ögren <qtech@mailhost.net>

PRELIMINARY BETA. NOT FOR REDISTRIBUTION.

Active Filter: Butterworth (2nd order, 12 dB/octave, Lowpass)

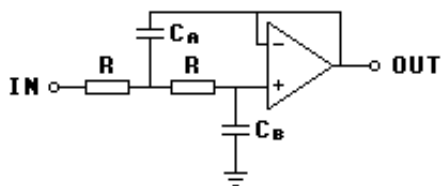

$R=4.7\text{k}-10\text{ k}\Omega$

$C_a=1.414/(2*\pi*F_c*R)$

$C_b=0.7071/(2*\pi*F_c*R)$

Units: R [Ω], C_x [F], F_c [Hz]

Contributor: Joakim Ögren <qtech@mailhost.net>

Source: ?

Please send any comments to Joakim Ögren <qtech@mailhost.net>

PRELIMINARY BETA. NOT FOR REDISTRIBUTION.

Active Filter: Butterworth (2st order, 12 dB/octave, Highpass)

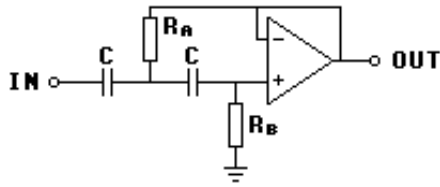

$$C=4.7\text{n}-10\text{nF}$$

$$R_a=0.7071/(2*\pi*F_c*C)$$

$$R_b=1.414/(2*\pi*F_c*C)$$

Units: R_x [Ohm], C [F], F_c [Hz]

Contributor: Joakim Ögren <qtech@mailhost.net>

Source: ?

Please send any comments to Joakim Ögren <qtech@mailhost.net>

PRELIMINARY BETA. NOT FOR REDISTRIBUTION.

Active Filter: Butterworth (3st order, 18 dB/octave, Lowpass)

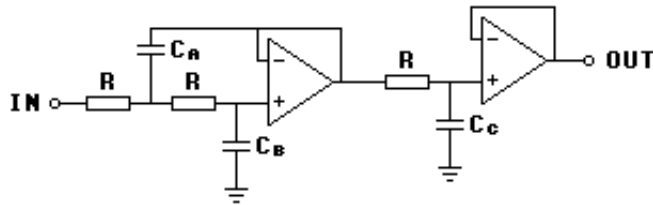

$R=4.7\text{k}-10\text{ k}\Omega$

$C_a=2.000/(2*\pi*F_c*R)$

$C_b=0.500/(2*\pi*F_c*R)$

$C_c=1.000/(2*\pi*F_c*R)$

Units: R [Ω], C_x [F], F_c [Hz]

Contributor: Joakim Ögren <qtech@mailhost.net>

Source: ?

Please send any comments to Joakim Ögren <qtech@mailhost.net>.

PRELIMINARY BETA. NOT FOR REDISTRIBUTION.

Active Filter: Butterworth (3st order, 18 dB/octave, Highpass)

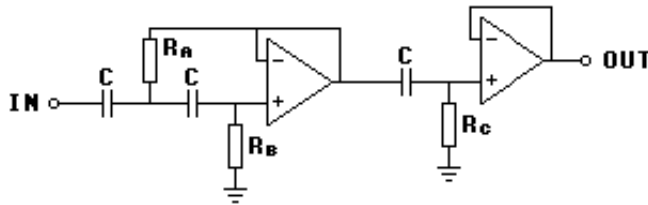

$$C=4.7\text{n}-10\text{nF}$$

$$R_a=0.500/(2*\pi*F_c*C)$$

$$R_b=2.000/(2*\pi*F_c*C)$$

$$R_c=1.000/(2*\pi*F_c*C)$$

Units: R_x [Ohm], C [F], F_c [Hz]

Contributor: Joakim Ögren <qtech@mailhost.net>

Source: ?

Please send any comments to Joakim Ögren <qtech@mailhost.net>.

PRELIMINARY BETA. NOT FOR REDISTRIBUTION.

Active Filter: Butterworth (4th order, 24 dB/octave, Lowpass)

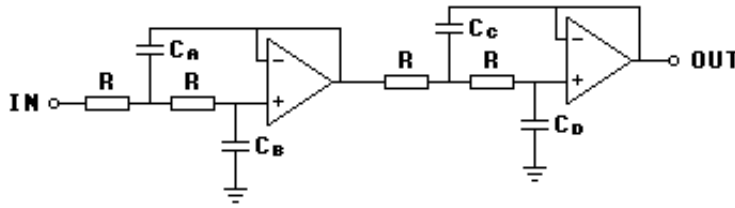

$R=4.7k-10\text{ k}\Omega$

$C_a=1.0824/(2\pi F_c R)$

$C_b=0.9239/(2\pi F_c R)$

$C_c=2.6130/(2\pi F_c R)$

$C_d=0.3827/(2\pi F_c R)$

Units: R [Ω], C_x [F], F_c [Hz]

Contributor: Joakim Ögren <qtech@mailhost.net>

Source: ?

Please send any comments to Joakim Ögren <qtech@mailhost.net>.

PRELIMINARY BETA. NOT FOR REDISTRIBUTION.

Active Filter: Butterworth (4th order, 24 dB/octave, Highpass)

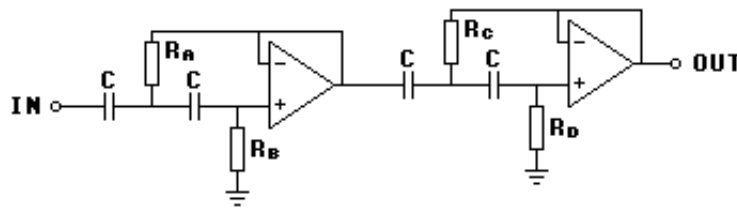

$$C=4.7\text{n}-10\text{nF}$$

$$R_a=0.9239/(2*\pi*F_c*C)$$

$$R_b=1.0824/(2*\pi*F_c*C)$$

$$R_c=0.3827/(2*\pi*F_c*C)$$

$$R_d=2.6130/(2*\pi*F_c*C)$$

Units: R_x [Ohm], C [F], F_c [Hz]

Contributor: Joakim Ögren <qtech@mailhost.net>

Source: ?

Please send any comments to Joakim Ögren <qtech@mailhost.net>.

Active Filter: Bessel (2nd order, 12 dB/octave, Lowpass)

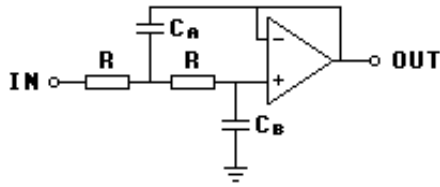

$R=4.7k-10\text{ k}\Omega$

$C_a=0.9076/(2\pi F_c R)$

$C_b=0.6809/(2\pi F_c R)$

Units: R [Ω], C_x [F], F_c [Hz]

Contributor: Joakim Ögren <qtech@mailhost.net>

Source: ?

Please send any comments to Joakim Ögren <qtech@mailhost.net>

PRELIMINARY BETA. NOT FOR REDISTRIBUTION.

Active Filter: Bessel (2st order, 12 dB/octave, Highpass)

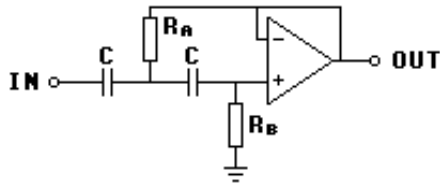

$C=4.7\text{n}-10\text{nF}$

$R_a=1.1017/(2*\pi*F_c*C)$

$R_b=1.4688/(2*\pi*F_c*C)$

Units: R_x [Ohm], C [F], F_c [Hz]

Contributor: Joakim Ögren <qtech@mailhost.net>

Source: ?

Please send any comments to Joakim Ögren <qtech@mailhost.net>

Active Filter: Bessel (3st order, 18 dB/octave, Lowpass)

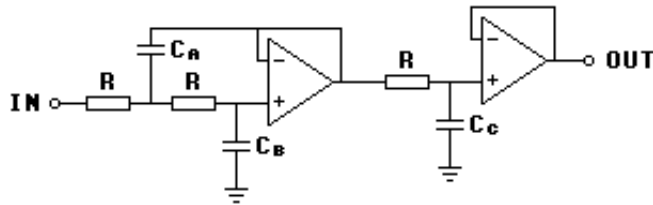

$R=4.7k-10\text{ k}\Omega$

$C_a=0.9548/(2\pi F_c R)$

$C_b=0.4998/(2\pi F_c R)$

$C_c=0.7560/(2\pi F_c R)$

Units: R [Ω], C_x [F], F_c [Hz]

Contributor: Joakim Ögren <qtech@mailhost.net>

Source: ?

Please send any comments to Joakim Ögren <qtech@mailhost.net>.

PRELIMINARY BETA. NOT FOR REDISTRIBUTION.

Active Filter: Bessel (3st order, 18 dB/octave, Highpass)

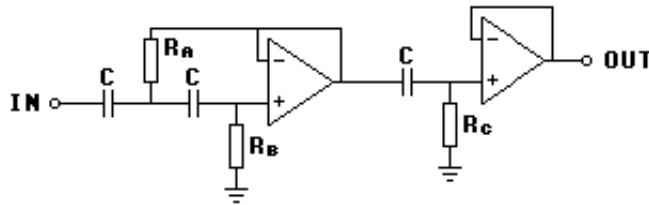

$$C=4.7\text{n}-10\text{nF}$$

$$R_a=1.0474/(2*\pi*F_c*C)$$

$$R_b=2.0008/(2*\pi*F_c*C)$$

$$R_c=1.3228/(2*\pi*F_c*C)$$

Units: R_x [Ohm], C [F], F_c [Hz]

Contributor: Joakim Ögren <qtech@mailhost.net>

Source: ?

Please send any comments to Joakim Ögren <qtech@mailhost.net>.

PRELIMINARY BETA. NOT FOR REDISTRIBUTION.

Active Filter: Bessel (4th order, 24 dB/octave, Lowpass)

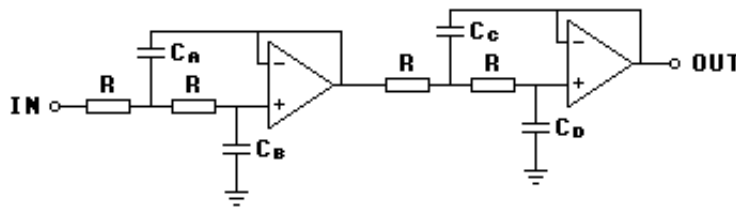

$R=4.7k-10\text{ k}\Omega$

$C_A=0.7298/(2\pi F_c R)$

$C_B=0.6699/(2\pi F_c R)$

$C_C=1.0046/(2\pi F_c R)$

$C_D=0.3872/(2\pi F_c R)$

Units: R [Ω], C_x [F], F_c [Hz]

Contributor: Joakim Ögren <qtech@mailhost.net>

Source: ?

Please send any comments to Joakim Ögren <qtech@mailhost.net>.

PRELIMINARY BETA. NOT FOR REDISTRIBUTION.

Active Filter: Bessel (4th order, 24 dB/octave, Highpass)

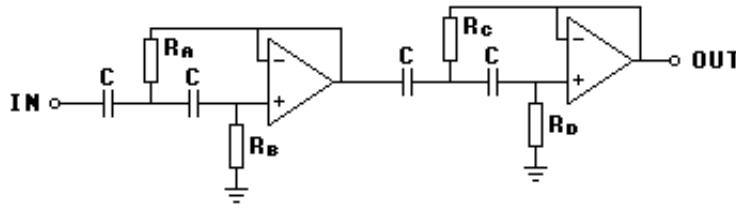

$C=4.7\text{n}-10\text{nF}$

$R_a=1.3701/(2*\pi*F_c*C)$

$R_b=1.4929/(2*\pi*F_c*C)$

$R_c=0.9952/(2*\pi*F_c*C)$

$R_d=2.5830/(2*\pi*F_c*C)$

Units: R_x [Ohm], C [F], F_c [Hz]

Contributor: Joakim Ögren <qtech@mailhost.net>

Source: ?

Please send any comments to Joakim Ögren <qtech@mailhost.net>.

Active Filter: Linkwitz (4th order, 24 dB/octave, Lowpass)

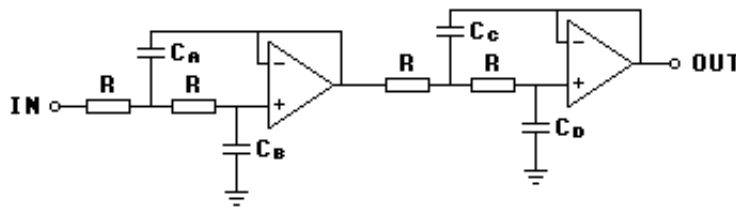

$R=4.7k-10\text{ k}\Omega$

$C_A=C_C=2\cdot C_B$

$C_B=C_D=1/(2\cdot\sqrt{2}\cdot\pi\cdot F_c\cdot R)$

Units: R [Ω], C_x [F], F_c [Hz]

Contributor: Joakim Ögren <qtech@mailhost.net>

Source: ?

Please send any comments to Joakim Ögren <qtech@mailhost.net>.

Active Filter: Linkwitz (4st order, 24 dB/octave, Highpass)

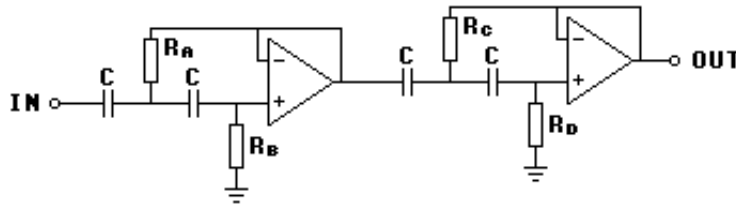

$$C=4.7\text{n}-10\text{nF}$$

$$R_a=R_c=1/(2*\text{sqr}(2)*\text{pi}*F_c*C)$$

$$R_b=R_d=2R_a$$

Units: R_x [Ohm], C [F], F_c [Hz]

Contributor: Joakim Ögren <qtech@mailhost.net>

Source: ?

Please send any comments to Joakim Ögren <qtech@mailhost.net>.

Definition: DTE & DCE

DTE

DTE is acronym for Data Terminal Equipment.

Examples of DTE is computers, printers & terminals.

DCE

DCE is acronym for Data Communication Equipment.

Examples of DCE is modems.

Wiring

Wiring a cable for DTE to DCE communication is easy. All wires goes straight from pin x to pin x.

But wiring a cable for DTE to DTE (nullmodem) or DCE to DCE requires that some wires are crossed. A signal should be wire from pin x to the opposite signal at the other end. With opposite signals I mean for example Transmit & Receive.

Contributors: Joakim Ögren <qtech@mailhost.net> , Richard L. Lane <rlane@eastman.com>

Source: ?

Please send any comments to Joakim Ögren <qtech@mailhost.net>.

Chapter 6

Table Menu

- AWG, American Wire Gauge standard
- SI Prefixes, Is 1 kW equal 1000000mW ?

Last updated 1997-09-07.

(C) Joakim Ögren <qtech@mailhost.net> 1996,1997

PRELIMINARY BETA. NOT FOR REDISTRIBUTION.

AWG

AWG=American Wire Gauge standard

Gauge AWG	Diam mm	Area mm ²	R ohm/km	I at 3A/mm ² mA
46	0,04	0,0013	13700	3,8
44	0,05	0,0020	8750	6
42	0,06	0,0028	6070	9
41	0,07	0,0039	4460	12
40	0,08	0,0050	3420	15
39	0,09	0,0064	2700	19
38	0,10	0,0078	2190	24
37	0,11	0,0095	1810	28
	0,12	0,011	1520	33
36	0,13	0,013	1300	40
35	0,14	0,015	1120	45
	0,15	0,018	970	54
34	0,16	0,020	844	60
	0,17	0,023	757	68
33	0,18	0,026	676	75
	0,19	0,028	605	85
32	0,20	0,031	547	93
30	0,25	0,049	351	147
29	0,30	0,071	243	212
27	0,35	0,096	178	288
26	0,40	0,13	137	378
25	0,45	0,16	108	477
24	0,50	0,20	87,5	588
	0,55	0,24	72,3	715
	0,60	0,28	60,7	850
22	0,65	0,33	51,7	1,0 A
	0,70	0,39	44,6	1,16 A
	0,75	0,44	38,9	1,32 A
20	0,80	0,50	34,1	1,51 A
	0,85	0,57	30,2	1,70 A
19	0,90	0,64	26,9	1,91 A
	0,95	0,71	24,3	2,12 A
18	1,00	0,78	21,9	2,36 A
	1,10	0,95	18,1	2,85 A
	1,20	1,1	15,2	3,38 A
16	1,30	1,3	13,0	3,97 A
	1,40	1,5	11,2	4,60 A
	1,50	1,8	9,70	5,30 A
14	1,60	2,0	8,54	6,0 A
	1,70	2,3	7,57	6,7 A
13	1,80	2,6	6,76	7,6 A
	1,90	2,8	6,05	8,5 A
12	2,00	3,1	5,47	9,4 A

Contributor: Joakim Ögren <qtech@mailhost.net>

Source: ?

Please send any comments to Joakim Ögren <qtech@mailhost.net>.

SI Prefixes

Example: 1 TW=1000 GW (W=Watt)

Symbol Prefix Factor

T	tera	10 ¹²
G	giga	10 ⁹
M	Mega	10 ⁶
k	kilo	10 ³
h	hecto	10 ²
da	deca	10 ¹
d	deci	10 ⁻¹
c	centi	10 ⁻²
m	milli	10 ⁻³
μ	micro	10 ⁻⁶
n	nano	10 ⁻⁹
p	pico	10 ⁻¹²
f	femto	10 ⁻¹⁵
a	atto	10 ⁻¹⁸

Note: In the computer world things are a bit different:

Symbol Prefix Factor Factor

T	tera	240	1099511627776
G	giga	230	1073741824
M	Mega	220	1048576
k	kilo	210	1024

Contributor: Joakim Ögren <qtech@mailhost.net>

Source: Farnell Components Catalogue

Please send any comments to Joakim Ögren <qtech@mailhost.net>

PRELIMINARY BETA. NOT FOR REDISTRIBUTION.

Chapter 7

Download Menu

The Hardware Book is available in some other formats as well. Since these are converted from HTML the result may sometimes look a little bit strange. If there is some major visual errors or if a link doesn't work, feel free to send an e-mail. These versions is currently to be considered as beta. And btw, if you like to see HwB in some other format, let me know.

Visit HwB at Internet <<http://www.blackdown.org/~hwb/hwb.html>> to download these versions.

(C) Joakim Ögren <qtech@mailhost.net> 1996, 1997

PRELIMINARY BETA. NOT FOR WIDE DISTRIBUTION.

Chapter 8

HwB-News Menu

If you would like to be informed about what's happening with the Hardware Book, the HwB-News letter may be something for you. It will contain:

- Updates of The Hardware Book
- News concerning HwB.
- Info about HwB errors/typos.
- Related WWW Links

To subscribe to the HwB-News mailinglist send a mail with the text SUBSCRIBE in the body to hwb-news-request@www.blackdown.org <hwb-news-request@www.blackdown.org>

To unsubscribe to the HwB-News mailinglist send a mail with the text UNSUBSCRIBE in the body to hwb-news-request@www.blackdown.org <hwb-news-request@www.blackdown.org>

The mailing list is not a discussion mailinglist. It only contains mail from me, Joakim Ögren.

Note: It's a low traffic mailing list. Unsubscribe whenever you want, every mail contains unsubscribe instructions.

(C) Joakim Ögren <qtech@mailhost.net> 1996, 1997

Chapter 9

Wanted

Please help me make this reference guide larger. I guess there is much more to add. Don't hesitate to send some strange pinout, circuit or cable.

If you have a strange serial-port on your dish-washer, SEND it to me :-)

If it doesn't have one you could send me a circuit on how to add a serial-port to it. :-)

I have already heard from two people that have a serial port on their dish-washers :)

I'm especially searching for the following standards:

- ECB
- EIB
- USB
- IEEE1394 Firewire
- SMP16
- TURBOchannel
- SA1000
- JVC bus?
- PC-Engine/TurboGrafix 16 connectors
- Qbus
- STEbus
- SBus
- MULTIBUS
- MULTIBUS II
- MTM-Bus
- GIO
- FutureBus+
- Nec PC-FX connectors
- Kenwood CD-Player RS232-port (For example DP-M7750).
- Epson Sample E04974 Diskdrive with Signals+Power in the usual 34 pin connector.

Other information of value:

- Filters

If you have any of the above listed please send me an e-mail at qtech@mailhost.net <qtech@mailhost.net>.

(C) Joakim Ögren <qtech@mailhost.net> 1996,1997

Chapter 10

About Hardware Book

What about this? Your free reference guide to electronics.

The Hardware Book is a compilation of pinouts I've found from different sources. I've tried to have the same style for all pages. This makes it easier to find information for you. I'm not trying to sell anything.

It has been developed on my sparetime and is made available to you for free. This also means that I can't guarantee that the presented information is correct. Use it on you own risk. I can't take the whole credit for HwB. I have since the first release received a great lot of mails with suggestions, questions and information. With the help of many contributors HwB has grown. Keep sending me mails...

This is me, Joakim Ögren:



Could it be even better? Perhaps if You help me. Please send any material you have that might be of interest for this project. Send it to qtech@mailhost.net <qtech@mailhost.net>.

I'm looking for a sponsor, if you're interested please let me know and I'll tell you more.

All new information since the last update is marked **NEW** and updated or changed information is marked **UPDATED**.

I would like to thank the following people:

Niklas Edmundsson for helping me find some of the information in HwB and being a nice friend..

Karl Asha for letting me use his web-server to store HwB.
Tomas Ögren my brother, for comments and helping me with HwB.



This is what I feel like doing when nothing works :-)

(C) Joakim Ögren <qtech@mailhost.net> 1996, 1997

PRELIMINARY BETA. NOT FOR REDISTRIBUTION.

BETA RELEASE

Index

+4 User Port Connector	312	Atari ST Monitor Connector	171
144 pin SO DIMM Connector	258	C-bus II Connector	109
168 pin DRAM DIMM (Unbuffered) Connector	261	C128 Expansion Bus Connector	308
168 pin SDRAM DIMM (Unbuffered) Connector	265	C128 RGBI Connector	182
3.5 mm Mono Telephone plug	277	C128/C64C Video Connector	183
3.5 mm Stereo Telephone plug	278	C128/C64C to CBM 1902A Monitor Cable	379
3.5" Power Connector	282	C128/C64C to SCART (S-Video) Cable	380
30 pin SIMM Connector	251	C16/+4 Expansion Bus Connector	310
3b1/7300 Video Connector	174	C16/C116/+4 Audio/Video Connector	184
5.25" Power Connector	281	C16/C116/+4 Cassette Connector	246
6.25 mm Mono Telephone plug	279	C16/C116/+4 Joystick Connector	191
6.25 mm Stereo Telephone plug	280	C64 Audio/Video Connector	180
64NET Cable	353	C64 Cartridge Expansion Connector	305
72 pin ECC SIMM Connector	254	C64 Cassette Connector	245
72 pin SIMM Connector	252	C64 Centronics Printer Cable	350
72 pin SO DIMM Connector	256	C64 Control Port Connector	190
8" Floppy Diskdrive Connector	211	C64 Power Supply Connector	328
9 to 15 pin VGA Cable	377	C64 RS232 User Port Connector	128
9 to 25 Serial Adapter	393	C64 Serial I/O Connector	148
A1000 to Amiga Parallel Adapter	404	C64 User Port Connector	307
AT Backup Battery Connector	285	C65 Video Connector	181
AT LED/Keylock Connector	286	CBM 1902A Connector	185
AT&T 53D410 Connector	176	CD32 Expansion-port Connector	95
AT&T 6300 Keyboard Connector	209	CDTV Diagnostic Slot Connector	313
AT&T 6300 Taxan Monitor Connector	177	CDTV Expansion Slot Connector	315
AT&T PC6300 Connector	178	CDTV Memory Card Connector	269
ATA (44) Internal Connector	234	CDTV Video Slot Connector	161
ATA Internal Connector	232	CGA Connector	153
AUI Connector	292	CM-8/CoCo RGB Connector	175
AWG Table	424	Cable Menu	332
About Hardware Book	429	Cable Tutorial	334
Active Filter: Bessel 12dB Highpass	415	CardBus Connector	99
Active Filter: Bessel 12dB Lowpass	414	Centronics Connector	139
Active Filter: Bessel 18dB Highpass	417	Centronics to LapLink Adapter	394
Active Filter: Bessel 18dB Lowpass	416	Cisco Console (25) Cable	356
Active Filter: Bessel 24dB Highpass	419	Cisco Console (9) Cable	355
Active Filter: Bessel 24dB Lowpass	418	Cisco Console Port Connector	130
Active Filter: Butterworth 12dB Highpass	409	CoCo Cassette Connector	247
Active Filter: Butterworth 12dB Lowpass	408	CoCo Serial Printer Connector	132
Active Filter: Butterworth 18dB Highpass	411	Commodore 1084 & 1084S (Analog) Connector	163
Active Filter: Butterworth 18dB Lowpass	410	Commodore 1084 & 1084S (Digital) Connector	164
Active Filter: Butterworth 24dB Highpass	413	Commodore 1084d & 1084dS Connector	165
Active Filter: Butterworth 24dB Lowpass	412	CompactFlash Connector	107
Active Filter: Butterworth 6dB Highpass	407	CompactPCI (Tech) Connector	55
Active Filter: Butterworth 6dB Lowpass	406	CompactPCI Connector	48
Active Filter: Linkwitz 24dB Highpass	421	Connector Menu	2
Active Filter: Linkwitz 24dB Lowpass	420	Connector Top 10 Menu	330
Adapter Menu	389	Connector Tutorial	8
Adapter Tutorial	390	Conrad Electronics MM3610D (25) Cable	358
Amiga 1000 RF Monitor Connector	160	Conrad Electronics MM3610D (9) Cable	357
Amiga 1000 Ramex Connector	91	Conrad Electronics MM3610D Connector	133
Amiga 1200 CPU-port Connector	88	DEC DLV11-J Serial Connector	129
Amiga 4 Joysticks Adapter	401	DEC Dual RS-232 Connector	124
Amiga External Diskdrive Connector	212	DIN Audio Connector	276
Amiga Mouse/Joy Connector	189	DIN to Mini-DIN Keyboard Adapter	396
Amiga Video Connector	159	Defintion: DTE & DCE	422
Amiga Video Expansion Connector	93	Download Menu	426
Amiga to C1084 Monitor Cable	378	ECP Parallel (Tech) Connector	138
Amiga to SCART Cable	376	ECP Parallel Connector	137
Amstrad CPC6128 Diskdrive 2 Connector	214	EGA Connector	154
Amstrad CPC6128 Monitor Connector	169	EISA (Tech) Connector	29
Amstrad CPC6128 Plus External Diskdrive Connector	215	EISA Connector	26
Amstrad CPC6128 Plus Monitor Connector	170	ESDI Cable	372
Amstrad CPC6128 Printer Port Connector	142	ESDI Connector	235
Amstrad CPC6128 Stereo Connector	329	Ethernet 10/100Base-T Connector	290
Amstrad CPC6128 Tape Connector	250	Ethernet 10/100Base-T Crossover Cable	382
Amstrad Digital Joystick Connector	200	Ethernet 10/100Base-T Straight Thru Cable	383
Atari 2600 Cartridge Connector	293	Ethernet 100Base-T4 Connector	291
Atari 2600 Joystick Connector	197	Ethernet 100Base-T4 Crossover Cable	384
Atari 5200 Cartridge Connector	294	Floppy Cable	366
Atari 5200 Expansion Connector	295	GEOCable Cable	354
Atari 6200 Joystick Connector	198	GameBoy Cartridge Connector	300
Atari 7800 Cartridge Connector	296	GeekPort Connector	146
Atari 7800 Expansion Connector	297	HwB-News Menu	427
Atari 7800 Joystick Connector	199	IDE Cable	367
Atari ACSI DMA Connector	149	IDE Internal Connector	230
Atari Cartridge Port Connector	298	ISA (Tech) Connector	13
Atari Enhanced Joystick Connector	196	ISA Connector	10
Atari Floppy Port Connector	217	IndustrialPCI Connector	58
Atari Jaguar A/V Connector	166	Internal Diskdrive Connector	210
Atari Mouse/Joy Connector	195	Keyboard (5 Amiga) Connector	205

Index

Keyboard (5 PC) Connector	202	SCART Connector	274
Keyboard (6 Amiga) Connector	206	SCSI Cable (Amiga/Mac)	368
Keyboard (6 PC) Connector	203	SCSI Cable (D-Sub to Hi D-Sub)	369
Keyboard (Amiga CD32) Connector	207	SCSI External Centronics 50 (Differential) Connector	222
Keyboard (XT) Connector	204	SCSI External Centronics 50 (Single-ended) Connector	221
LapLink/InterLink Parallel Cable	351	SCSI External D-Sub (Future Domain) Connector	227
MDA (Hercules) Connector	156	SCSI External D-Sub (PC/Amiga/Mac) Connector	228
MIDI Cable	387	SCSI Internal (Differential) Connector	219
MIDI In Connector	326	SCSI Internal (Single-ended) Connector	218
MIDI Out Connector	325	SCSI-II External Hi D-Sub (Differential) Connector	225
MSX Cassette Connector	248	SCSI-II External Hi D-Sub (Single-ended) Connector	224
MSX Expansion Connector	301	SGI Mouse (Model 021-0004-002) Connector	193
MSX External Diskdrive Connector	213	SI Prefixes Table	425
MSX Joystick Connector	192	SNES Cartridge Connector	317
MSX Parallel Connector	140	SNES Video Connector	167
Mac to C64 Nullmodem Cable	339	SSFDC Connector	113
Mac to HP48 Cable	359	ST506/412 Cable	370
Macintosh External Drive Connector	216	ST506/412 Connector	237
Macintosh Keyboard Connector	208	Serial (Amiga 1000) Connector	120
Macintosh Modem (With DTR) Cable	344	Serial (Amiga) Connector	121
Macintosh Modem (Without DTR) Cable	345	Serial (MSX) Connector	122
Macintosh Mouse Connector	194	Serial (PC 25) Connector	119
Macintosh RS-422 Connector	125	Serial (PC 9) Connector	118
Macintosh Serial Connector	127	Serial (Printer) Connector	123
Macintosh Video Connector	158	Serial Port Loopback (25 CheckIt)	365
Macintosh Video to VGA Adapter	403	Serial Port Loopback (25 Norton)	363
Mini-DIN to DIN Keyboard Adapter	395	Serial Port Loopback (9 CheckIt)	364
Miniature Card (Tech) Connector	76	Serial Port Loopback (9 Norton)	362
Miniature Card Connector	74	Serial Printer (25-25) Cable	349
Minuteman UPS Connector	327	Serial Printer (9-25) Cable	348
Misc Menu	405	Serial to PS/2 Mouse Adapter	400
Misc Unsupported Cables	388	SmallPCI Connector	73
Mitsumi CD-ROM Connector	240	SmartCard AFNOR Connector	271
Modem (25-25) Cable	341	SmartCard ISO 7816-2 Connector	272
Modem (9-25) Cable	340	SmartCard ISO Connector	273
Motherboard CPU Cooling fan Connector	289	Sony CD-ROM Connector	244
Motherboard IrDA Connector	288	Spectravideo SVI318/328 Audio/Video Connector	186
Motherboard Power Connector	283	Spectravideo SVI318/328 Cassette Connector	249
NeoGeo Audio/Video Connector	168	Spectravideo SVI318/328 Expansion Bus Connector	322
NeoGeo Joystick Connector	201	Spectravideo SVI318/328 Game Cartridge Connector	324
NeoGeo to SCART Cable	381	Sun Video Connector	172
Novell and Procomp External SCSI Connector	229	TG-16 Cartridge Connector	319
NuBus 90 Connector	81	Table Menu	423
NuBus Connector	78	The Hardware Book (PDF)	1
Nullmodem (25-25) Cable	338	Turbo LED Connector	284
Nullmodem (9-25) Cable	337	Two-Wire Modem (25-25) Cable	343
Nullmodem (9-9) Cable	336	Two-Wire Modem (9-25) Cable	342
Nullmodem Adapter	392	Unibus Connector	115
PC 2 Joysticks Adapter	402	Universal Serial Bus (USB) (Tech) Connector	144
PC Card ATA Connector	103	Universal Serial Bus (USB) Connector	143
PC Card Connector	101	VESA Feature Connector	157
PC Gameport Connector	187	VESA LocalBus (VLB) (Tech) Connector	45
PC Gameport+MIDI Connector	188	VESA LocalBus (VLB) Connector	42
PC Speaker Connector	287	VGA (15) Connector	151
PC-Engine Cartridge Connector	316	VGA (9) Connector	152
PC/104 Connector	114	VGA (VESA DDC) Connector	150
PCI (Tech) Connector	37	Vic 20 Memory Expansion Connector	303
PCI Connector	33	Vic 20 Video Connector	179
PCMCIA Connector	105	Video to TV SCART Cable	375
PGA Connector	155	Wanted	428
PS/2 Keyboard (Gateway) Y Adapter	397	X1541 Cable	386
PS/2 Keyboard (IBM Thinkpad) Y Adapter	398	ZX Spectrum 128 RGB Connector	173
PS/2 to Serial Mouse Adapter	399	ZX Spectrum AY-3-8912 Connector	320
Panasonic CD-ROM Connector	242	ZX Spectrum ULA Connector	321
ParNet Parallel Cable	352	Zorro II Connector	84
ParaLoad Cable	385	Zorro II/III Connector	86
Parallel (Amiga 1000) Connector	136		
Parallel (Amiga) Connector	135		
Parallel (Olivetti M10) Connector	141		
Parallel (PC) Connector	134		
Parallel Port Loopback (CheckIt)	361		
Parallel Port Loopback (Norton)	360		
Paravision SX-1 External IDE Connector	239		
Paravision SX1 to IDE Cable	374		
PlayStation A/V Connector	162		
Printer Cable	347		
RS232 Connector	117		
RS422 Connector	126		
RocketPort Serial (25) Cable	346		
RocketPort Serialport Connector	131		
S-Video Connector	275		